



DRAFT WESTMEAD SOUTH MASTER PLAN

Transport Study

7 MAY 2024



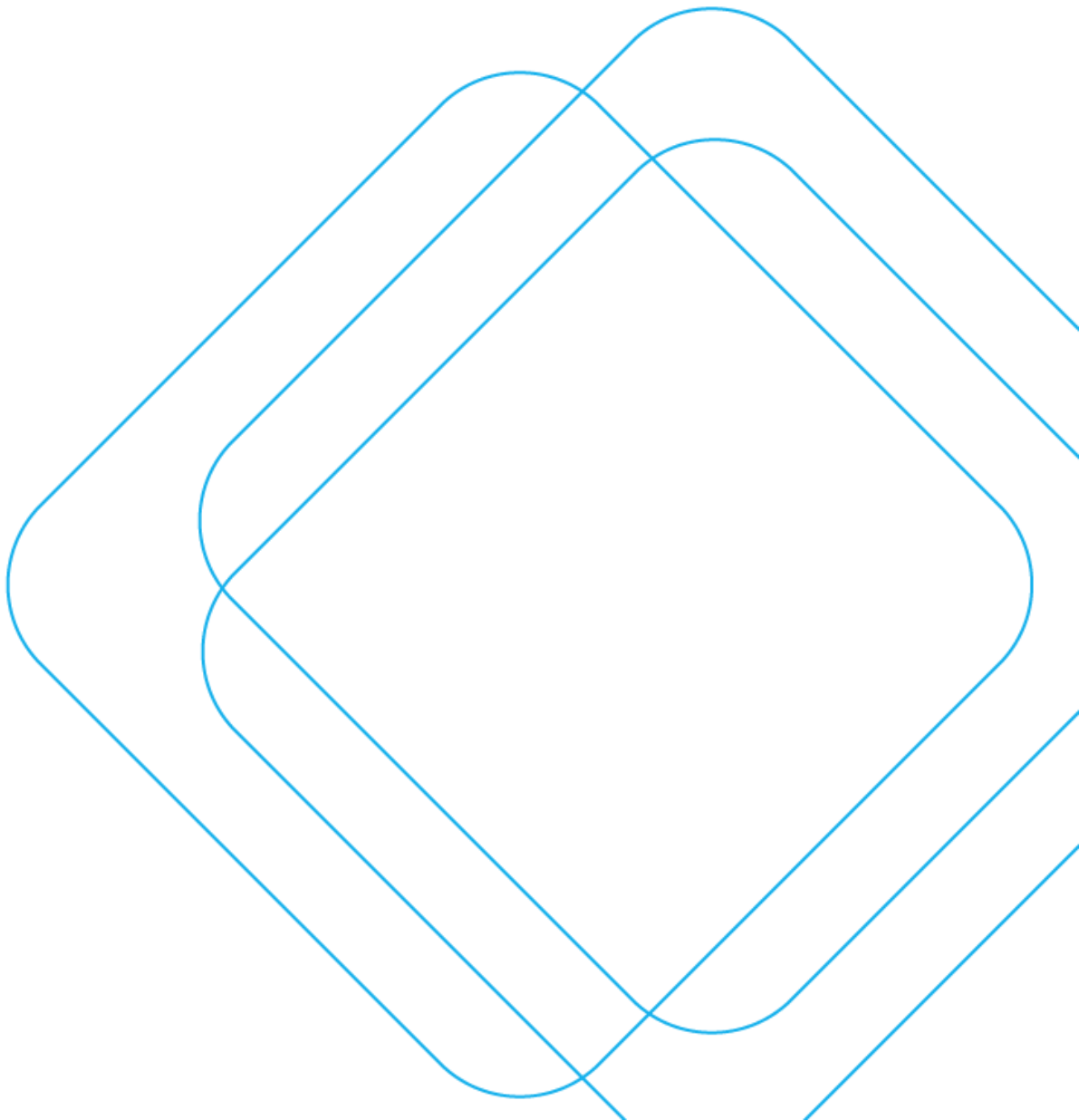

SCT Consulting acknowledges the traditional owners of the lands on which we work.
We pay our respects to Elders past, present and emerging.



Quality Assurance

Project:	Draft Westmead South Master Plan		
Project Number:	SCT_00410		
Client:	Cumberland City Council	ABN:	22 798 563 329
Prepared by:	SCT Consulting PTY. LTD. (SCT Consulting)	ABN:	53 612 624 058

Information	Name	Position	Signature
Author:	Jonathan Busch	Associate Director	
Reviewer:	Andy Yung	Director	
Authoriser:	Andy Yung	Director	

Version	Date	Details
1.0	2 May 2023	Table of contents issue
2.0	26 May 2023	Existing conditions issue
3.0	20 October 2023	Draft report
4.0	26 October 2023	Updates to respond to Council comments on order, next steps and messaging
5.0	30 October 2023	Final report
6.0	23 February 2024	Updated master plan layout based on community consultation
7.0	29 February 2024	Updated master plan layout based on community consultation
8.0	29 February 2024	Minor text edits
9.0	29 April 2024	Updated master plan layout based on Local Planning Panel submissions
10.0	7 May 2024	Minor edits to Section 2.2.3



© SCT Consulting PTY LTD (SCT Consulting)

SCT Consulting's work is intended solely for the use of the Client and the scope of work and associated responsibilities outlined in this document. SCT Consulting assumes no liability with respect to any reliance that the client places upon this document. Use of this document by a third party to inform decisions is the sole responsibility of that third party. Any decisions made or actions taken as a result of SCT Consulting's work shall be the responsibility of the parties directly involved in the decisions or actions. SCT Consulting may have been provided information by the client and other third parties to prepare this document which has not been verified. This document may be transmitted, reproduced or disseminated only in its entirety and in accordance with the above.

Contents

Context.....	i
Existing conditions	i
Master plan	ii
Mode shift action plan	ii
Parking action plan.....	iii
Performance assessment	iii
Action plan	v
Next steps	v
1.0 Introduction	1
1.1 Report purpose	1
1.2 Structure	2
2.0 Context.....	3
2.1 NSW Government.....	3
2.1.1 Future Transport Strategy	3
2.1.2 Road user space allocation policy.....	4
2.1.3 Walking space guidelines.....	4
2.1.4 Sydney Green Grid	6
2.1.5 The Central City District Plan	8
2.1.6 Greater Parramatta to Olympic Peninsula Place-based Infrastructure Compact	8
2.1.7 Westmead 2036 Place Strategy & Transport Strategy.....	10
2.1.8 Westmead 2036 Public Domain Strategy	16
2.1.9 Sydney Metro West.....	20
2.1.10 Parramatta Light Rail Stage 1	22
2.2 Cumberland City Council	25
2.2.1 Cumberland 2030: Our Local Strategic Planning Statement.....	25
2.2.2 The Open Space and Recreation Strategy	26
2.2.3 Walking and Cycling Strategy	28
2.2.4 Westmead South Centre Traffic and Transport Study (2022)	29
2.3 City of Parramatta	31
2.3.1 City of Parramatta draft Bike Plan 2023.....	31
2.3.2 Mays Hill Precinct Master Plan	33
3.0 Existing conditions	34
3.1 Context	34
3.2 Travel behaviours	36
3.2.1 All day mode share	36
3.2.2 Travel to work mode share.....	37
3.3 Road	38
3.4 Parking.....	42
3.5 Walking	43
3.6 Cycling	49
3.7 Bus.....	51
3.8 Rail.....	54
4.0 Draft Westmead South Master Plan.....	55
4.1 Structure plan	55
4.2 Road hierarchy	57
4.3 Multi-modal functionality	59
4.4 Cross-sections	59
4.5 Transport upgrades.....	60

5.0	Parking strategy	61
5.1	Principles	61
5.2	Expected areas of parking impact	61
5.3	Parking action plan	63
6.0	Modal shift action plan	65
6.1	Principles	65
6.2	Benchmarking	65
6.3	Target mode share	68
6.4	Modal shift action plan	69
7.0	Performance evaluation	71
7.1	Performance metrics	71
7.2	Model scope	71
7.3	Future year assumptions	74
7.3.1	Background growth assumptions	74
7.3.2	Traffic generation rates	74
7.4	Need for scenario testing	75
7.5	Existing conditions scenario	76
7.5.1	Assumptions	76
7.5.2	Network performance	79
7.5.3	Intersection performance	80
7.6	Scenario 1: Current parking controls	81
7.6.1	Assumptions	81
7.6.2	Network performance	85
7.6.3	Intersection performance	86
7.7	Scenario 2: Maximum parking controls	87
7.7.1	Assumptions	87
7.7.2	Network performance	88
7.7.3	Intersection performance	89
7.8	Discussion	90
8.0	Conclusion	93
8.1	Study conclusions	93
8.2	Next steps	93

Appendices

Appendix A	Parking restrictions and occupancy
Appendix B	SIDRA Movement Summaries

Executive Summary

Context

Westmead was identified by (then) Department of Planning and Environment (DPE) as an education, health, and housing precinct in 2020. DPE prepared a place strategy in partnership with Transport for NSW (TfNSW), who prepared a place-based transport strategy for the area.





Cumberland City Council is progressing planning for the Westmead South Precinct, which is the southern portion of DPE’s Westmead precinct.

This transport study builds on the initial work undertaken by TfNSW, progressing the level of definition of the transport needs and infrastructure suitable to a level for a planning proposal for the area.

The outputs of the transport study will inform the preparation of a Development Control Plan, including road typologies, parking controls, and specific transport networks such as cycle corridors. The infrastructure upgrades identified in this study will inform amendments to the Cumberland Local Environment Plan 2021 and to inform land take requirements for any changed street networks. Any street expansion projects (e.g. widened footpaths, new bus lanes) that require land take would be captured in land reservation and acquisition maps. Lastly, the transport proposals will also inform the contribution mechanisms for the area, ensuring that the infrastructure is appropriately funded by the uplift.

This report is being released for public comment so the community can have a say about the draft Westmead South Master Plan.

Existing conditions

	Place	<p>Westmead South is situated with Parramatta CBD to the east and the Westmead Health and Innovation District to the north.</p> <p>Parramatta CBD is Sydney’s Central City. It caters for a mix of commercial, residential, and retail offerings. In the 2022 estimated residential population was 15,211 residents and approximately 81,900 jobs. Westmead South is home to two schools: Westmead Public School and Sacred Heart Catholic Primary School. It also has several local public open spaces, including the M J Bale Park.</p>
	Walking	<p>Walking accounts for 4.8 per cent of current journey to work trips (2016 data) and 35.4 per cent of all daily journeys.</p> <p>Almost all streets in Westmead South have footpaths on at least one side, and all of the key road corridors have footpaths on both sides (such as Hawkesbury Road, Bridge Road and Great Western Highway). The future Mays Hill Precinct Master Plan will complete missing links in Parramatta Park, providing connectivity to Parramatta CBD.</p>
	Cycling	<p>Cycling accounts for 0.1 per cent of current journey to work trips (2016 data) and up to 2.6 per cent of all daily journeys.</p> <p>Westmead South sits between two Green Grid connections, the M4 shared path links, which join Wentworthville to Sydney Olympic Park and Wentworth Point via Auburn, Granville and Parramatta and the Parramatta Valley Cycleway.</p> <p>The site has great potential to be a cycling precinct.</p>
	Public transport	<p>The combined frequency of the bus services is significant – about 76 services in the morning and 83 services in the evening peak hours.</p> <p>Rail frequency at Westmead station is 23 services per hour in the morning and 26 in the evening peak.</p>
	Car	<p>The crash history shows a pattern of crashes focussed on the more significant road corridors, particularly Great Western Highway, Bridge Road, Hawkesbury Road and Houison Road all have some history of incidents as well.</p> <p>Traffic modelling conducted shows that route travel times are at levels typical for urban networks, but Bridge Road southbound operates with slow speeds in the evening peak – 8km/h. Hawkesbury Road operates at 17-25km/h, which is reflective of delays occurring at intersections. Great Western Highway operates at 36-43km/h, which reflects reasonably fast travel times. This is likely associated with phase timings which allocate more time to Great Western Highway than the approaches from Hawkesbury Road, Bridge Road and Coleman Street.</p>

Master plan

Council's draft vision for Westmead South is:

Westmead South will have evolved into a unique place, providing living and employment close to public transport.

It will be a smart precinct built upon its rich Indigenous and historical heritage, leveraging health and innovation uses in broader Westmead area.

Its character will be further defined by high quality public spaces, diverse building typologies and uses. A network of green spaces coupled with walking and cycling initiatives will ensure Westmead South evolves into a liveable inner city precinct distinct itself from the surrounding suburbs.

The urban design vision for the draft Westmead South Master Plan is that:

Westmead South will be one of the best connected places in Sydney. New open spaces, upgraded streets, improved cycle and pedestrian connectivity is fundamental to delivering a sustainable outcome for Westmead South.

This vision captures the importance of **transformative transport connectivity** to the realisation of success at Westmead South.

This structure plan has several transformative elements for the transport system:

- Hawkesbury Road will function as a High Street, providing north-south cycling connectivity in fulfilment of Council's Draft Walking and Cycling Strategy Route 4, which connects Westmead to Merrylands via the M4 Cycleway.
- Strengthened cycling infrastructure running east-west along Alexandra Avenue.
- Creation of a north-south green link from M J Bennett Reserved through to Alexandra Avenue
- Strengthening of Amos Street as a connection through to Parramatta CBD.

The draft Westmead South Master Plan Urban Design Report provides explanation of each of the elements of the structure plan. **This plan should be read in conjunction with the urban design report.**

Mode shift action plan

The mode shift action plan is based on the following principles:



Low car ownership enforced in parking controls

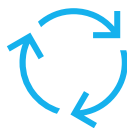

An integrated, multi-modal network



Greening of streets



Connections to public open space

Six infrastructure actions and three development control plan actions were identified to support mode shift in the precinct. This plan recommends that maximum parking controls be adopted rather than Council's current approach with minimum parking rates.

Parking action plan

The parking action plan is based on the following principles:



Target car parking occupancy of 80-90%



Manage commuter car parking requirements



Support car share, bus zones, freight & servicing

Parking controls will need to be updated over time to reduce the overspill of parking into residential areas and to achieve acceptable levels of parking occupancy. Four actions were identified to support this.

Performance assessment

The evaluation of the proposed upgrades from **Section 4.5** requires a multi-modal lens. The following performance metrics are evaluated for the transport solution:

- Mode share
- Distance to cycling network
- Public transport accessibility level
- % tree canopy
- Average footpath width
- Vehicle travel speeds.

A SIDRA Network model was developed for testing of road network operational performance metrics. SIDRA Network is an analytical approach to the measurement of performance for the road network. This means that delays, queue lengths and blocking impacts between intersections are based on a collection of empirically validated equations.

The existing conditions performance was determined based on traffic surveys conducted on 27 June 2023 and 2 August 2023. Intersection turning volumes (the number of vehicles turning left, through and right at each road) and queue length surveys were collected to inform the SIDRA Network model.

This transport assessment is based on the transport demands from a total of 7,760 apartments. The draft Master Plan supports a total uplift accounting 6,621 dwellings, which is 9,880 less the existing dwellings (3,259). Therefore, modelling has been conducted using this conservative approach.

The travel time performance shows a decline, particularly for Great Western Highway in the direction of peak travel (eastbound in the morning and westbound in the evening).

The introduction of parking rates provides mitigation of impacts, including:

- Hawkesbury Road, which travels 6km/h faster northbound and 2km/h faster southbound in the evening peak.
- Great Western Highway eastbound, which experiences a 3km/h increase in travel speeds in the morning peak.

A comparison of travel times side by side is provided in **Table E-1**.

Table E-1 Comparison of travel times (change in speed compared to existing conditions)

Route	Existing conditions	With development	
		Scenario 1: existing parking controls	Scenario 2: maximum parking controls
AM			
Hawkesbury Road northbound	21km/h	13km/h (-8km/h)	13km/h (-8km/h)
Hawkesbury Road southbound	23km/h	23km/h	25km/h (+2km/h)
GWH eastbound	43km/h	18km/h (-25km/h)	21km/h (-22km/h)
GWH westbound	37km/h	48km/h (+11km/h)	49km/h (+12km/h)
Bridge Road northbound	28km/h	28km/h	28km/h
Bridge Road southbound	32km/h	23km/h (-9km/h)	25km/h (-7km/h)
PM			
Hawkesbury Road northbound	25km/h	20km/h (-5km/h)	26km/h (+1km/h)
Hawkesbury Road southbound	21km/h	22km/h (+1km/h)	25km/h (+4km/h)
GWH eastbound	40km/h	37km/h (-3km/h)	37km/h (-3km/h)
GWH westbound	36km/h	17km/h (-19km/h)	17km/h (-19km/h)
Bridge Road northbound	27km/h	34km/h (+7km/h)	34km/h (+7km/h)
Bridge Road southbound	19km/h	11km/h (-8km/h)	13km/h (+-6km/h)

The preferred option for the study is the adoption of maximum parking controls for Westmead South only, which reduce the impacts of congestion on the future community.

Action plan

The transport action plan to support the master plan is summarised below.

Table E-2 Action plan

Action	
Infrastructure	
I.1	Deliver a walking and cycling-focused, activated Hawkesbury Road
I.2	Deliver cycling connection on Amos Street
I.3	Deliver cycling connection on Alexandra Avenue
I.4	Deliver north-south walking and cycling connection from M J Bennett Reserve
I.5	Deliver a program of streetscape improvements
I.6	Deliver footpath and access improvements in Westmead South
Westmead South-specific development controls	
D.1	Establish a maximum parking control for Residential - Flat Buildings and Shop Top Housing
D.2	Update minimum bicycle parking controls for Residential - Flat Buildings and Shop Top Housing
D.3	Require Green Travel Plans be prepared for developments
Road upgrades	
R.1	Reconfigure Hawkesbury Road corridor including all intersections from Alexandra Avenue through to Pye Street
R.2	Bridge Road / Grand Avenue capacity increases
R.3	Bridge Road / Moree Avenue left in left out treatment
R.4	Bridge Road / Austral Avenue signalisation
R.5	Bridge Road widening over the rail corridor
R.6	Capacity increases at Great Western Highway / Bridge Road
R.7	Capacity increases at Great Western Highway / Hawkesbury Road / Coleman Street
Parking	
P.1	Extend coverage of 2P on-street parking
P.2	Manage on-street parking occupancy actively
P.3	Manage permit scheme closely
P.4	Manage commuter car parking requirements

Next steps

This report is an initial proposal for transport planning to support Westmead South and will accompany Council's exhibition to the community. This plan will evolve through community consultation and engagement with Government authorities such as Transport for NSW, School Infrastructure NSW and the Department of Planning and Environment.

1.0 Introduction

1.1 Report purpose

Westmead was identified by Department of Planning and Environment (DPE) as an education, health, and housing precinct in 2020. DPE prepared a place strategy in partnership with Transport for NSW (TfNSW), who prepared a place-based transport strategy for the area.

Cumberland City Council is progressing planning for the Westmead South Precinct, which is the southern portion of DPE's Westmead precinct (**Figure 1-1**)

Figure 1-1 Westmead South Precinct



Source: Cumberland City Council, 2022

This transport study builds on the initial work undertaken by TfNSW, progressing the level of definition of the transport needs and infrastructure suitable to a level for a planning proposal for the area.

The outputs of the transport study will inform the preparation of a Development Control Plan, including road typologies, parking controls, and specific transport networks such as cycle corridors.

The infrastructure upgrades in this study will inform the zoning in the local environment plan and to inform land take requirements for any changed street networks. Any street expansion projects (e.g. widened footpaths, new bus lanes) that require land take would be captured in land reservation and acquisition maps.

Lastly, the transport proposals will also inform the contribution mechanisms for the area, ensuring that the infrastructure is appropriately funded by the uplift.

This report is being released for public comment so the community can have a say about the draft Westmead South Master Plan.

1.2 Structure

This report is structured as follows:

- **Section 1.0** explains the purpose of the report so community members and NSW Government agencies can understand how it forms part of the planning process for the precinct.
- **Section 2.0** describes the planning context of the precinct. The context is important because the policy of the relevant government authorities shape the priorities and ultimately the transport proposals for Westmead South.
- **Section 3.0** captures the existing conditions of Westmead South. It describes how people travel now in the area and the networks they use for travel.
- **Section 4.0** describes the proposal for Westmead South, including the land uses, the street cross-sections and key parts of the transport network proposals.
- **Section 5.0** is the modal shift action plan, which is about creating realistic tools and actions to make it easier and more attractive to use sustainable modes of transport. To ensure that goals are realistic, the section includes analysis of benchmark precincts to predict what would be a realistic future to plan for.
- **Section 5.0** is the parking strategy, which considers parking considerations (on-street, off-street, and commuter parking) for the precinct.
- **Section 7.0** is the transport impact assessment of the land use uplift. It assesses how users of each mode of transport would be affected by the uplift and confirms the infrastructure requirements by mode.
- **Section 8.0** is the conclusion, which summarises the key findings of the study.

2.0 Context

2.1 NSW Government

2.1.1 Future Transport Strategy

The *Future Transport Strategy* sets out the NSW Government’s vision for transport in a growing and changing state. The Strategy will guide the community on strategic directions for future planning, investment, delivery and operations and has been developed in consultation across the NSW Government. The Future Transport Strategy builds on the success of Future Transport 2056, released in 2018, and sets out Transport for NSW’s (TfNSW) long-term vision to provide a safe, sustainable, accessible and integrated travel network for all passenger and freight journeys. The vision is to help make NSW the most liveable state in the world.

The Strategy was updated from the Future Transport 2056 Strategy to address significant social, cultural and economic trends/events such as the COVID-19 pandemic, the energy transition, the digital economy and enduring natural disasters. It also considers population growth, new and emerging technology, and global megatrends.

The new Strategy continues to put people and places at the centre of decision making and has a renewed focus on ensuring NSW is an economic powerhouse filled with vibrant and sustainable communities where people are connected by one integrated and multimodal transport system. The key vision and outcomes from the strategy along with brief descriptions are shown in **Figure 2-1**.

Figure 2-1 Vision and outcomes



Source: Future Transport Strategy, TfNSW 2022

Walking and cycling are key focuses of the Future Transport Strategy. The Strategy’s vision includes several actions that align precinct planning including:

- working with local communities to create safer, greener and more liveable 15-minute neighbourhoods across NSW, where wider footpaths, cycle lanes, street trees, pedestrian crossings and lower speeds will improve access to nearby shops and services
- recognising active travel as critical in the delivery of effective and reliable transport networks and allocated dedicated space wherever possible
- improving lighting, widening and improving the surface of footpaths to increase safety, creating new pedestrian crossings, installing ramps and elevators, providing additional seating and vehicle pick-up and drop-off zones
- reducing traffic in centres with high pedestrian activity and improving the safety of people walking and cycling
- making busy local centres and neighbourhoods safer with traffic calming measures to reduce speed as well as new pedestrian crossings, pedestrian refuges, raised footpaths and intersections
- continuing to invest in pedestrian crossings, refuge islands and traffic-calming measures
- prioritising pedestrian movements in and around key destinations, including at traffic signals.

Implications for Westmead South
 Planning for precincts needs to focus on sustainable mobility, particularly with walking and cycling priority.

2.1.2 Road user space allocation policy

The policy set out by Transport for NSW aims to allocate road space, both physically and temporally, based on a hierarchy of road users. **Figure 2-2** shows the hierarchy of road users with the primary consideration being given to walking and the least consideration provided to private cars.

The key principles applicable to Westmead South are the aim to reduce the mode share of private motor vehicles within built-up areas and the prioritisation of different road users, such as those who walk or cycle, during times of the day and times of the year. The policy gives the planning a priority to encourage walking, cycling and public transport use and consider last those travelling to the site by car.

Figure 2-2 Hierarchy of road user considerations

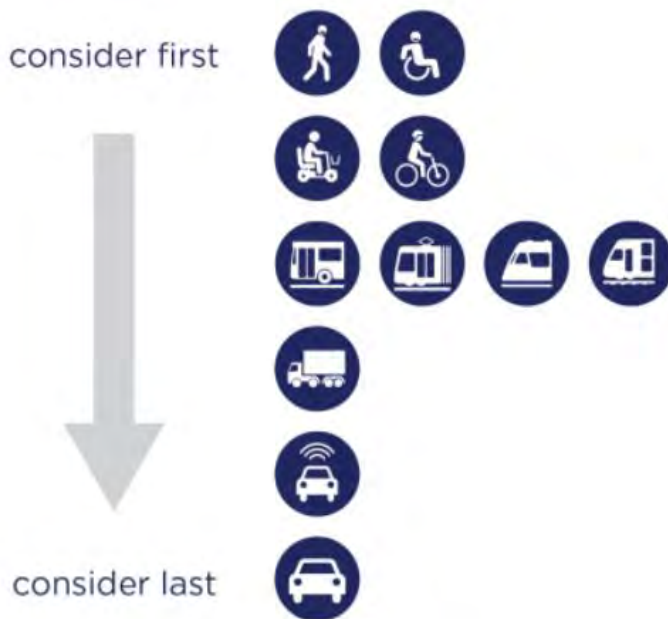

Source: Transport for NSW, 2021

Implications for Westmead South

Planning for the streets in Westmead should follow the modal hierarchy identified by TfNSW. Vehicle access remains important to each part of the suburb due to the access needs of freight, servicing (such as waste collection), ambulance and fire access. However, some streets may no longer be prioritised for car, particularly the northern section of Hawkesbury Road.

2.1.3 Walking space guidelines

TfNSW's Walking Space Guidelines provides a set of standards and tools to assist those responsible for Walking Spaces on streets, to ensure that sufficient space is provided to achieve comfortable environments which encourage people to walk.

Figure 2-3 provides a summary of typical space provisions for different types of facilities.

Figure 2-3 Types of walking spaces and buffers to traffic

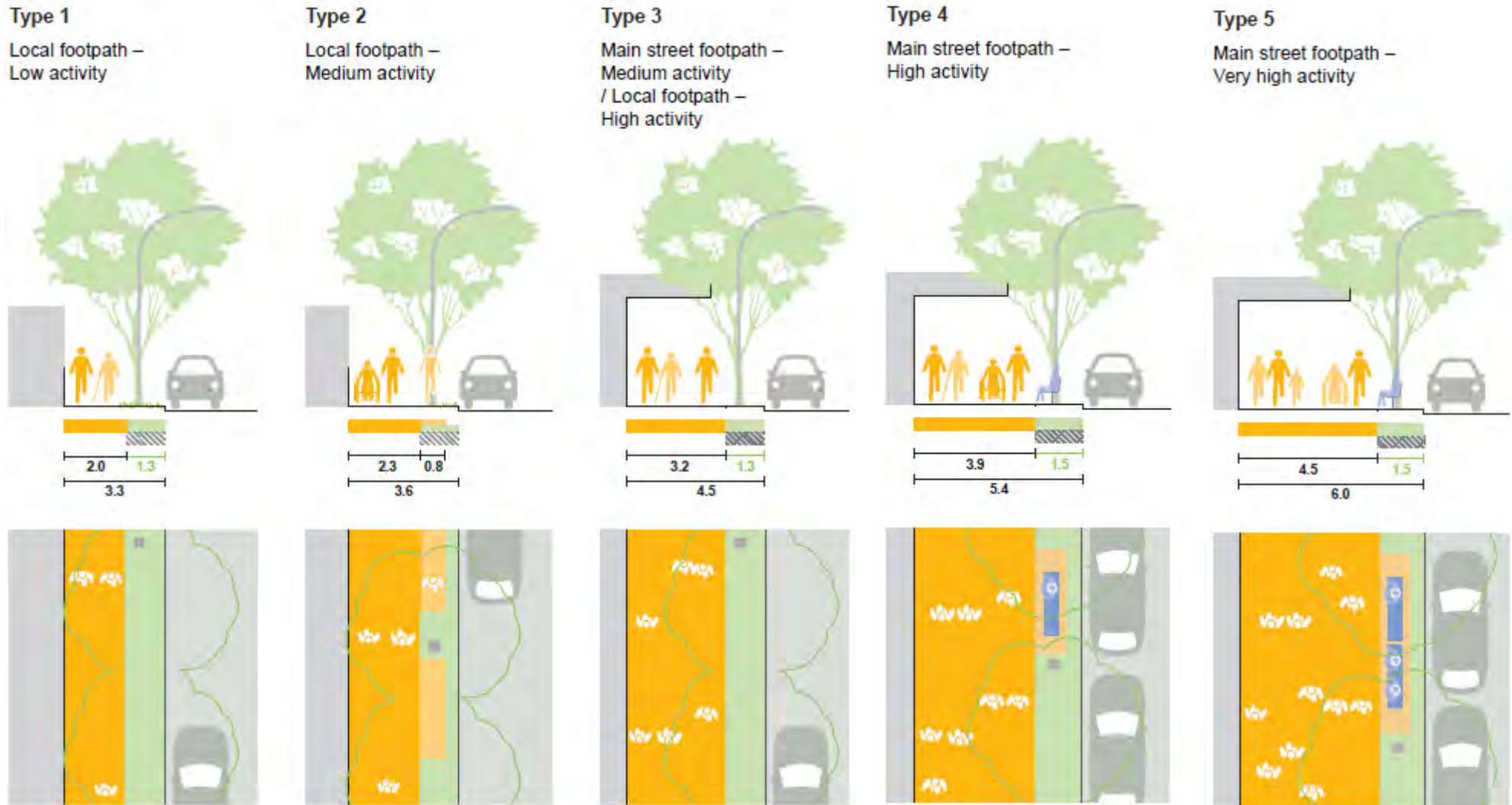

The walking space guidelines outlines a process to use Fruin level of service to determine the amount of space required for pedestrian space and maintain comfortable walking conditions.

Implications for Westmead South

Planning for pedestrian spaces, particularly those with heavy pedestrian demands need to consider an evidence-based approach to the determination of footpath dimensions. This would apply, for example, on Hawkesbury Road.

2.1.4 Sydney Green Grid

The Sydney Green Grid is a spatial framework for strategically significant green corridors in Sydney. It uses the forecast demographic figures and current natural assets to identify regionally significant open space projects to serve the future needs of Sydney. Westmead sits just south of the Parramatta River corridor (**Figure 2-4**), which is a regionally significant project.

Implications for Westmead South

The walking and cycling network should integrate Westmead South easily with the Parramatta River regional link.

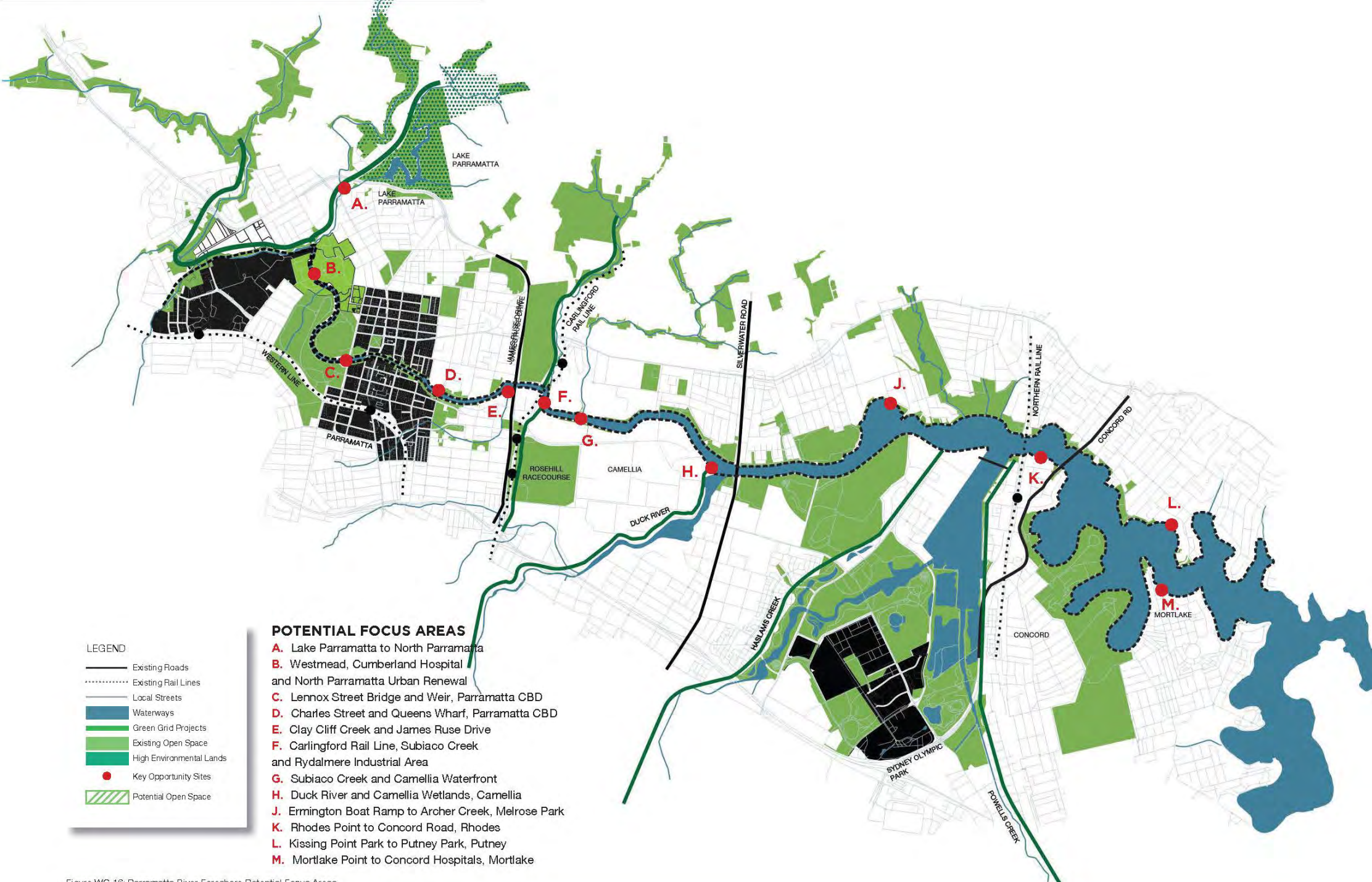

- POTENTIAL FOCUS AREAS**
- A.** Lake Parramatta to North Parramatta
 - B.** Westmead, Cumberland Hospital and North Parramatta Urban Renewal
 - C.** Lennox Street Bridge and Weir, Parramatta CBD
 - D.** Charles Street and Queens Wharf, Parramatta CBD
 - E.** Clay Cliff Creek and James Ruse Drive
 - F.** Carlingford Rail Line, Subiaco Creek and Rydalmere Industrial Area
 - G.** Subiaco Creek and Camellia Waterfront
 - H.** Duck River and Camellia Wetlands, Camellia
 - J.** Ermington Boat Ramp to Archer Creek, Melrose Park
 - K.** Rhodes Point to Concord Road, Rhodes
 - L.** Kissing Point Park to Putney Park, Putney
 - M.** Mortlake Point to Concord Hospitals, Mortlake

Figure WC.16. Parramatta River Foreshore Potential Focus Areas

Figure 2-4 Green Grid in Central West – Parramatta River

2.1.5 The Central City District Plan

The Cumberland LGA falls under the *Central City District Plan* (**Figure 2-5**) which is one of the three Greater Sydney Metropolis cities - the Western Parkland City, the Central River City and the Eastern Harbour City. The vision for the Central City District Plan will aim to improve the District’s lifestyle and environmental assets. This will be done through several actions, including linking parks, bushland, playgrounds and waterways through the Greater Sydney Green Grid with enhanced opportunities for safe walking and cycling paths.

Local centres are a part of many of the District’s great places and in the Cumberland LGA include Westmead, Auburn, Granville and Merrylands, which are all identified as key centres for the LGA. These centres have been identified in the District Plan as highly accessible and as important interchanges for bus and rail networks linking into strategic centres. They also provide essential access to day-to-day goods and services close to where people live.

Social connectors and important street life have also been pointed out as particularly evident in the centres of Parramatta CBD, Granville, Auburn and Merrylands. One of the characteristics of places with high concentrations of social connectors is ‘walkable town centres or eat streets’ which highlights the importance of a high-quality pedestrian network within these centres. As part of the periphery of Parramatta CBD, extending walking connections to Westmead is of high importance.

Figure 2-5 Central City District Plan



Source: The Central City District Plan, Greater Sydney Commission, March 2018

Implications for Westmead South

Greater Parramatta is the focal point of the Central City. Planning for Westmead needs to leverage the growth and status of Parramatta CBD, providing ease of connection to and from the precinct.

2.1.6 Greater Parramatta to Olympic Peninsula Place-based Infrastructure Compact

The Greater Parramatta to Olympic Peninsula (GPOP) Place-based Infrastructure Compact (PIC) identifies an approach to planning that is about aligning transport infrastructure and growth. Aligned with investment in Sydney

Metro West and Parramatta Light Rail Stage 1 (both under construction), Westmead South is identified as a precinct that should be prioritised for growth (Figure 2-6)

Figure 2-6 GOPP PIC Sequencing Plan Phase 1

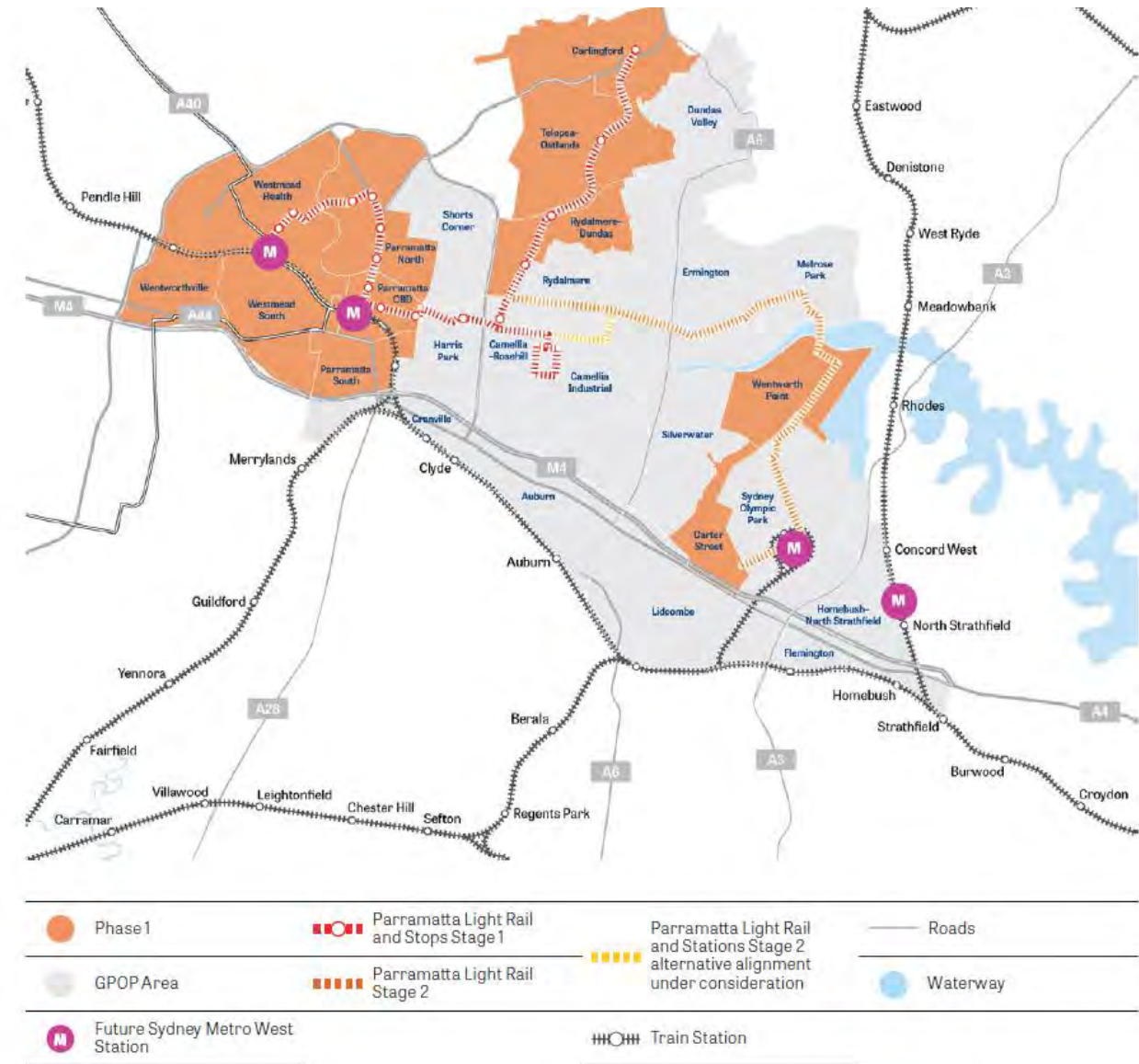

Source: (then) Greater Sydney Commission, 2019

Implications for Westmead South
 Westmead South precinct fulfills the planning for the PIC by delivering land use uplift in a location with good access to transport.

2.1.7 Westmead 2036 Place Strategy & Transport Strategy

The Westmead Place proposed a land use and transport structure plan for the precinct (**Figure 2-7** through **Figure 2-9**). The plan identifies the following big moves:

1. Drive change in the innovation eco-system to accelerate delivery of Australia's premier health and innovation district.
2. Cherish and protect places of significance, conserve and revitalise heritage and cultural assets to create exceptional places.
3. Activate and connect our community with vibrant, diverse and well connected public spaces and places.
4. Deliver high quality and diverse housing for students, workers and professionals with optimal liveability outcomes.
5. Capitalise on transport connectivity and reduce car dependency.

Transport is central to the big moves, being in moves 3 and 5. Big move 3 is about delivering public open spaces and providing walking and cycling connections to them. Big move 5 is about leveraging the significant investment in city-shaping public transport infrastructure to make walking, cycling, and public transport the preferred modes of transport.

The proposed connectivity map shows Hawkesbury Road as having street activation. Bridge Road as carrying bus services. Westmead Station will become an important public transport interchange, providing connectivity between T-way, bus, metro, trains and light rail.

The active transport network shows that Hawkesbury Road is the primary north south regional connection, with the supporting connections running east west from Hawkesbury Road. Bridge Road provides walking and cycling connectivity, but of a lower order than Hawkesbury Road.

The transport plan is provided in more detail in **Figure 2-10**. It shows a number of important proposals, including:

- A proposed 30km/h high pedestrian activity speed limit on Hawkesbury Road
- Road upgrades along Bridge Road
- Improved bus connectivity north-south along Hawkesbury Road
- New signals along Hawkesbury Road at the northern end
- A new north-south pedestrian link along the Unnamed Creek through to M J Bennet Reserve and then back to Hawkesbury Road.

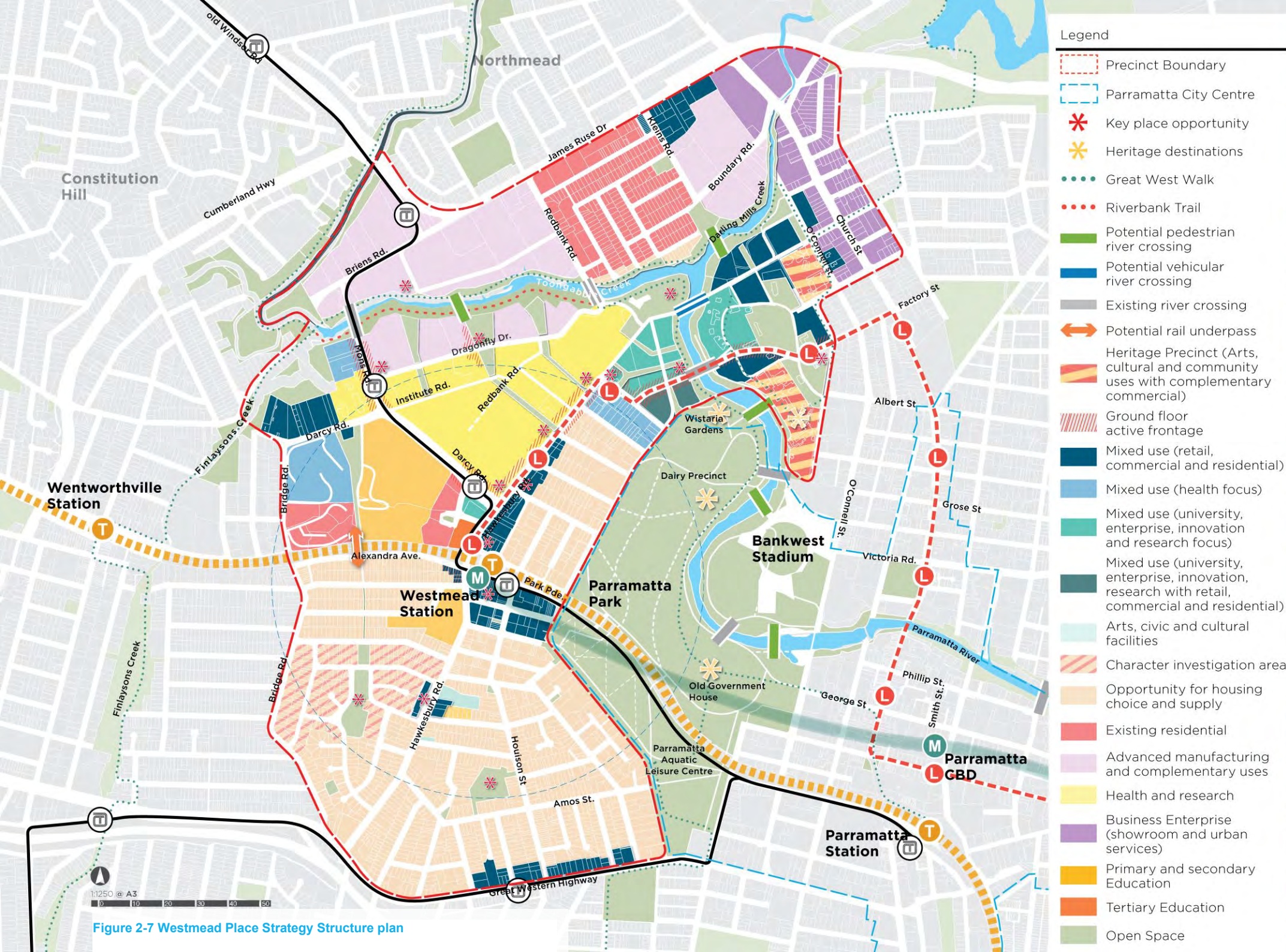

Figure 2-7 Westmead Place Strategy Structure plan

Connectivity

Direction 1

A well connected city

Direction 1
 Evolve Westmead to be a truly connected 30-minute city by leveraging new transport connections and improving existing networks within the Precinct, GOP and neighbouring centres.

- LEGEND**
- Precinct Boundary
 - Parramatta City Centre Boundary
 - Major Transport Interchange
 - Focal Point/ Active Corner
 - Activation Core
 - Street Activation
 - Existing Train Stations and Network
 - Parramatta Light Rail Stations and Network
 - Sydney Metro West Stations and Alignment
 - Local Bus Stations and Network
 - Tway Stations and Network
 - High Street
 - Transport Corridor - Potential Bus Route south

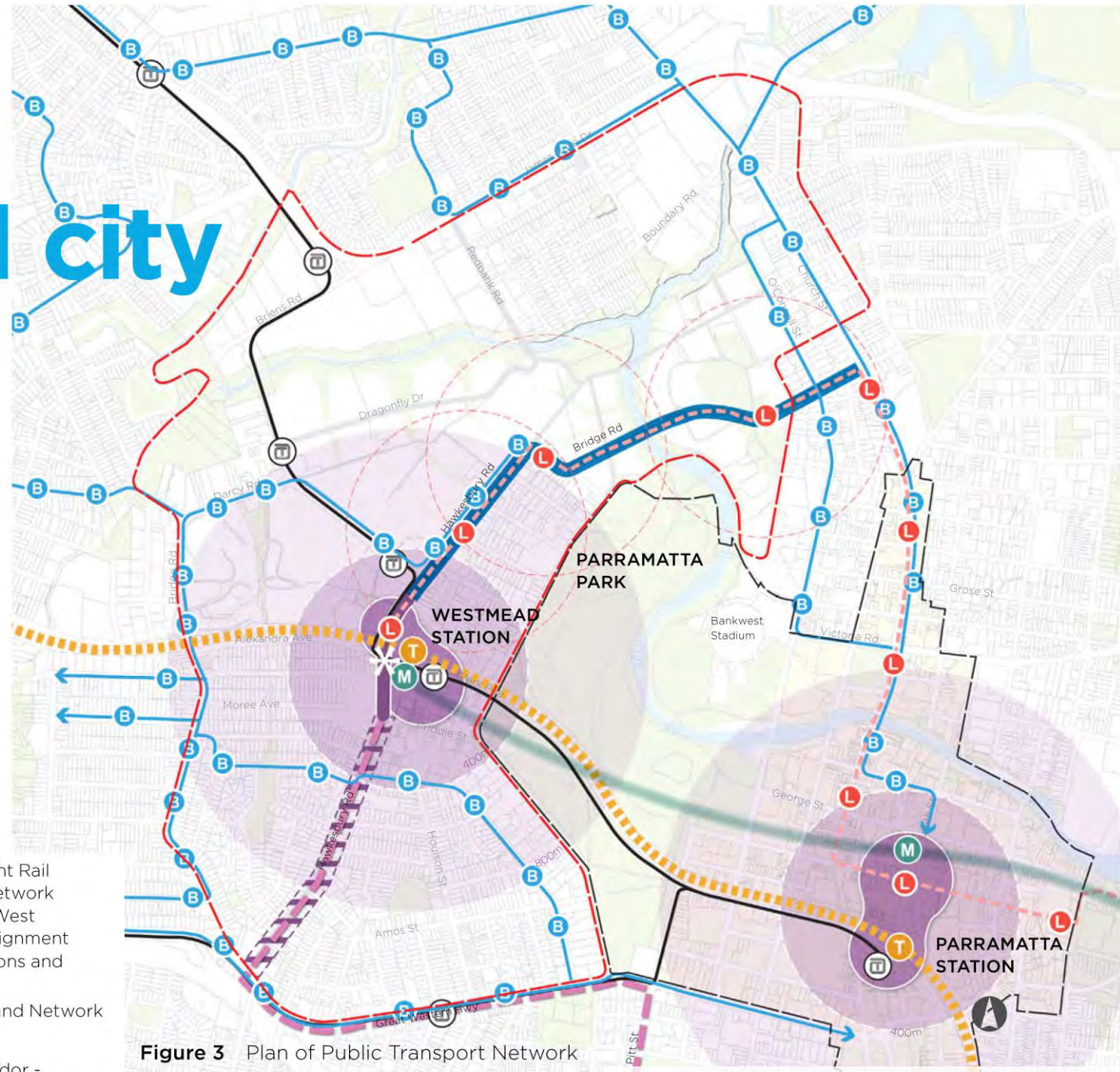

Figure 3 Plan of Public Transport Network

Figure 2-8 Westmead Place Strategy transport connectivity

Connectivity

Direction 2

A well connected city

Direction 2
 Encourage initiatives towards a safe walking and cycling city that is centred on pedestrian and cycleway connections that link to wider regional networks and surrounding places of interest.

LEGEND

- Precinct Boundary
- Parramatta City Centre Boundary
- Existing River Crossings
- Potential New River Crossings
- Existing Pedestrian Underpass
- Potential Pedestrian Underpass
- Key Pedestrian Spine
- Walking and Cycling Network
- Connecting Cycle Network
- River Walk

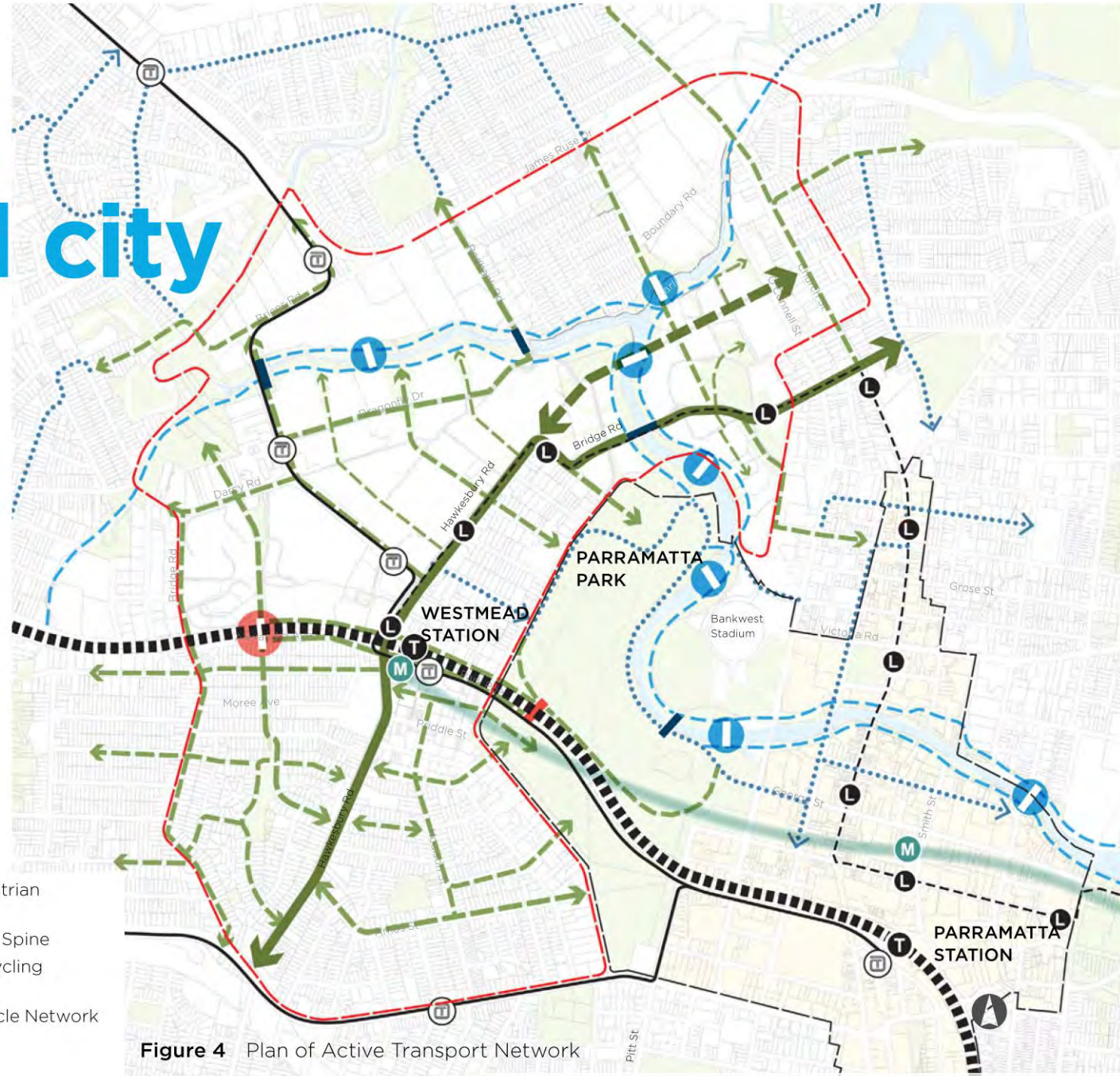

Figure 4 Plan of Active Transport Network

Figure 2-9 Westmead Place Strategy Active Transport Network

Transport initiatives



Figure 2-10 Westmead South Transport Initiatives

The transport strategy identifies a long list of initiatives that will be considered in this stage of planning which are relevant to Westmead South (**Table 2-1**). These initiatives have been categorised into the following categories:

- **Next stage:** these actions, if appropriate, will be identified for implementation by Council in the next stage of planning. These initiatives tend to be more specific than can be controlled in this stage (e.g. smart infrastructure could be identified in the planning proposal but would be refined and decisions made in the infrastructure design phase)
- **Interfacing:** these initiatives are owned by others and not under Council's control. The planning for the precinct will recognise and leverage the planning undertaken by others. Where appropriate, planning will advocate for a particular outcome. An example of this is the design of the Sydney Metro West interchange, which is owned by TfNSW.
- **Relevant:** an important decision on these initiatives needs to be made in this stage of planning.

Table 2-1 Westmead Transport Strategy initiatives

#	Initiative	Type
Strategic Direction 1: Support Westmead's transformation into a truly integrated innovation district		
1.1	Implement smart infrastructure and services	Next stage
1.2	Create a sense of arrival with the Sydney Metro station masterplan	Interfacing
1.3	Expand the TfNSW travel behaviour change program	Interfacing
1.4	Support electric mobility uptake	Relevant
1.5a	Improve safety of public and active transport	Next stage
1.6	Develop a precinct-wide parking strategy	Relevant
Strategic Direction 2: Create vibrant and safe places, leveraging the major movement corridors, parklands and creeks		
2.1	Re-imagined Hawkesbury Road	Relevant
2.2	Reduced speed limits on local streets	Relevant¹
2.3	Footpath treatments at local intersections	Next stage
2.4	Minimise new driveway crossings on high movement corridors	Next stage
2.6	Trial a School Street	Next stage
2.7	Improve pedestrian amenity near schools	Relevant
2.8	Network of landscaped cycling and walking paths	Relevant
Strategic Direction 3: Develop sustainable travel networks that are permeable and attractive		
3.1	Increase pedestrian and cyclist green time and frequency	Next stage ²
3.2	Signalised or priority crossings for pedestrians and cyclists	Relevant
3.3	Improve pedestrian amenity on Hawkesbury Road	Relevant
3.5	Improve the safety of Hawkesbury Road bridge	Interfacing
3.6	Active transport connections over and along creeks and rivers	Relevant
3.9	New active transport network	Relevant
Strategic Direction 4: Deliver better public and active transport options for customers of all ages and abilities		
4.1	Strategic bus planning for Greater Parramatta	Interfacing

¹ Speed limits will inform the kind of cross sections proposed, so need to be generally developed in this stage of planning

² This will inform traffic modelling assumptions during this stage

#	Initiative	Type
4.3	Frequent, direct and legible public transport connections	Interfacing
4.4	Pedestrian connectivity to mass transit	Relevant
4.5	Before and after school traffic management	Next stage ³
4.7	Safe, comfortable and efficient transport interchange hub	Interfacing
4.8	Connections to Westmead Public School by walking and cycling	Relevant
Strategic Direction 5: Enhance the transport network to optimise and balance movement		
5.2	Active transport railway crossings	Relevant
5.3	Reduce Westmead's attractiveness to through traffic	Relevant
5.5	Minimise growth in car parking supply and better manage existing supply	Relevant
5.7	Bridge Road upgrade	Relevant
5.8	Multi-modal wayfinding plan	Next stage
5.9	Optimise on-street parking, access and loading in high place-intensity areas	Relevant

Implications for Westmead South

The list of initiatives that re relevant for Westmead South need to be considered in this transport study and, where appropriate, decisions made on whether they should progress.

2.1.8 Westmead 2036 Public Domain Strategy

Greater Cities Commission prepared the Westmead 2036 Public Domain Strategy, which accompanies the Westmead 2036 Place Strategy, providing a proposed open space, walking and cycling network for the precinct. It provides an overall open space District Plan (**Figure 2-11**) which shows a network of public open spaces and improved streetscapes on existing roads. A new north-south open space network joins Unnamed Creek north of the rail corridor, then runs along the alignment of the existing through-site link from Alexandra Avenue to M J Bennet Reserve.

The pedestrian and cycle network proposed (**Figure 2-12**) shows that this north-south open space network is an important new pedestrian and cycling connection. Hawkesbury Road is also shown as a spine pedestrian and cycling route, providing strategic connectivity.

Some proposed cross sections are provided for Hawkesbury Road (**Figure 2-13**). Cross sections are shown at the northern, middle and southern portion of the road corridor in descending order. These cross sections show the intent to provide a dedicated cycleway along the entirety of the corridor.

Implications for Westmead South

The public domain proposals form a starting point for the future walking and cycling network of Westmead South that will be refined in this study.

³ This will inform traffic modelling assumptions during this stage

DISTRICT PLAN

WESTMEAD – A DISTRICT IN NATURE

Westmead will be re-imagined through green infrastructure. A network of green and blue spaces will provide a range of benefits to the District and its surrounds, including:

- recreation, amenity and healthy living
- reducing flooding
- cooling the urban environment
- encouraging walking and cycling
- enhancing biodiversity and ecological resilience
- connecting with Country.

Proposed open space

1. Toongabbie Creek/Parramatta River Green Space
2. Toongabbie Creek Park
3. The Confluence
4. Westmead Water Plaza
5. Innovation Precinct green link.

Upgrades to existing open space

6. Milson Park – including improvements to the creek confluence areas, where Finlaysons Creek meets Toongabbie Creek and Unnamed Creek meets Finlaysons Creek
7. Unnamed Creek – including upgrades to the existing Greenlink (between Alexandra Ave and Austral Ave)
8. Austral Ave Reserve
9. M J Bennett Reserve
10. Sydney Smith Park
11. Gateway Park
12. Institute Reserve.

Transforming Hawkesbury Road

13. Hawkesbury Road
14. Westmead Metro Plaza.

Upgrades to existing Hawkesbury Road civic spaces

15. Westmead Childrens Hospital Plaza
16. Helen Street Pocket Park
17. Railway Parade Station Plaza upgrade
18. The Oakes Centre Upgrade.

Improved connections and crossings

19. New crossing to facilitate walking connection along Unnamed Creek and onto Toongabbie Creek
20. Improved crossing of Mons Road to facilitate walking connection to Toongabbie Creek.

Existing tracks and trails

21. Great West Walk
22. Redbank Trail
23. Governor Phillip Walk.

Park entry street connections

24. Railway Parade
25. Queens Rd
26. Caroline St
27. Helen St
28. Jessie St
29. Hainsworth St.

New bridge crossings

30. a series of new and improved bridge crossings to facilitate connections whilst also enabling connections to existing tracks and trails including the Redbank Track and the Great West Walk.

This includes:

a new and improved bridge across Toongabbie Creek linking the District and Northmead; a series of new bridge crossings surrounding 'The Confluence'; and a number of new bridges crossing Parramatta River, creating a stronger connection between Parramatta North and Westmead.

Riparian Corridor

31. investigate potential link through 'Unnamed Creek' to connect open spaces.



- Creek confluences
- Creeklines and waterways
- Parks and Reserves
- Civic Space
- Open Space
- Tree canopy
- Schools
- Rail line
- Lightrail line and stop
- Proposed Metro
- On-road cycleway
- Governor Phillip Walk
- Regional trails – Great West Walk and Redbank Trail
- Hawkesbury Road
- Valley Streets
- Mini-wetlands
- Water Boulevards
- Park edge and park entry streets
- Front yards
- Bridge Road
- Boundary

Figure 2-11 Public Domain Strategy summary

DISTRICT PLAN

PEDESTRIAN AND CYCLE NETWORK

Across the District seven key initiatives are proposed to transform pedestrian and cycle connectivity. These are:

1. transforming Hawkesbury Road into the District's vibrant 'high' street
2. streetscape upgrades to create a cool, walkable street network
3. making Toongabbie Creek and Parramatta River accessible for all
4. re-connecting South Westmead to Toongabbie Creek through the creation of a continuous, publicly accessible shared path following the path of Unnamed Creek and its existing chain of parks (Refer to p.113 'Public Domain Strategies - Re-Connecting Westmead's Open Spaces' section for specific detail and proposals)
5. re-connecting the 'high' street (Hawkesbury Rd) and the 'low' ground - the District's waterways and parks
6. re-establishing the District's relationship to Parramatta Park whilst also enabling connections to existing tracks and trails including the Redbank Track and the Great West Walk. This includes: a new bridge across Toongabbie Creek linking the District and Northmead; a series of new bridge crossings surrounding 'The Confluence'; and a number of new bridges crossing Parramatta River, creating a stronger connection between Parramatta North and Westmead.
- 7.

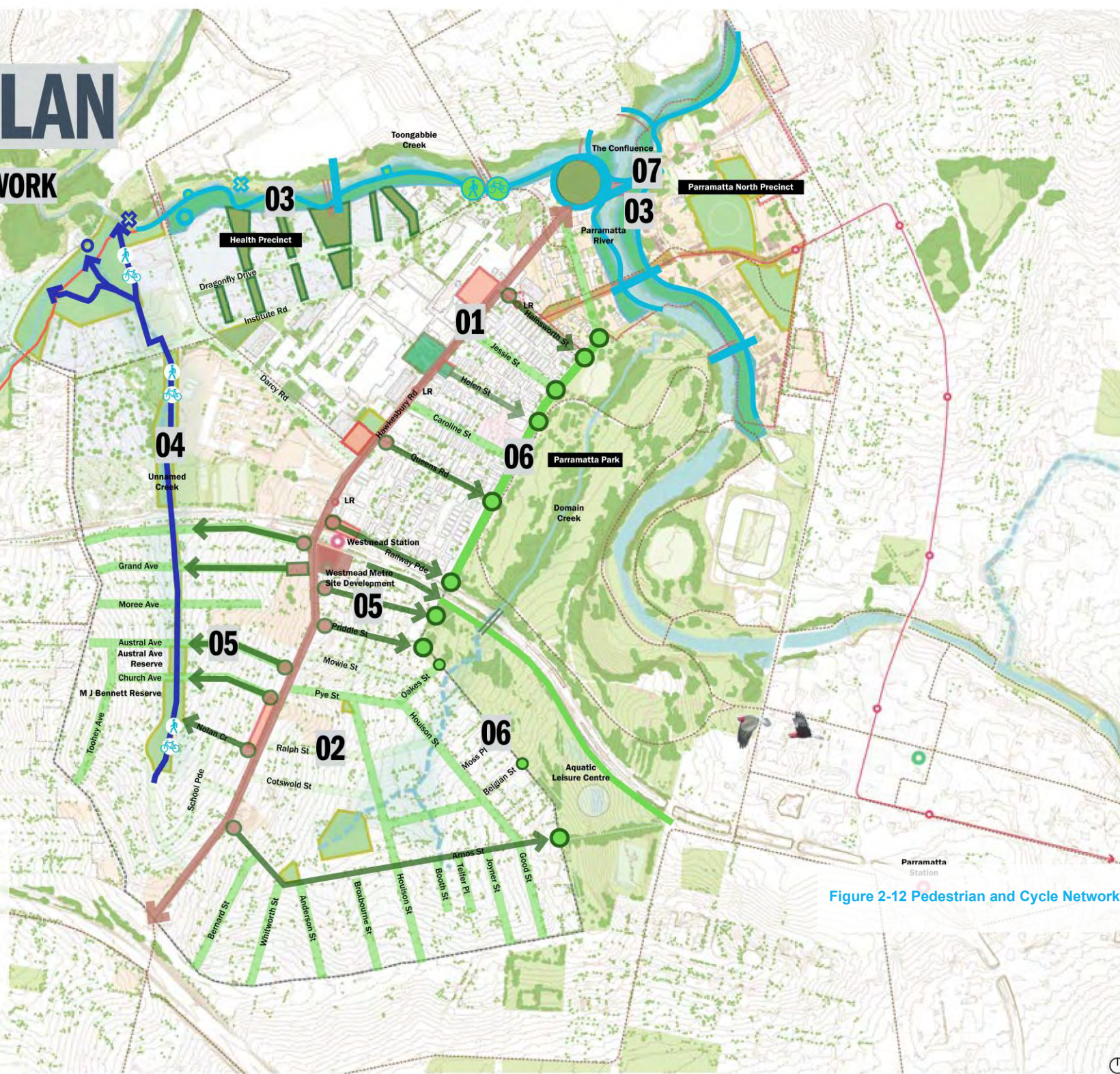
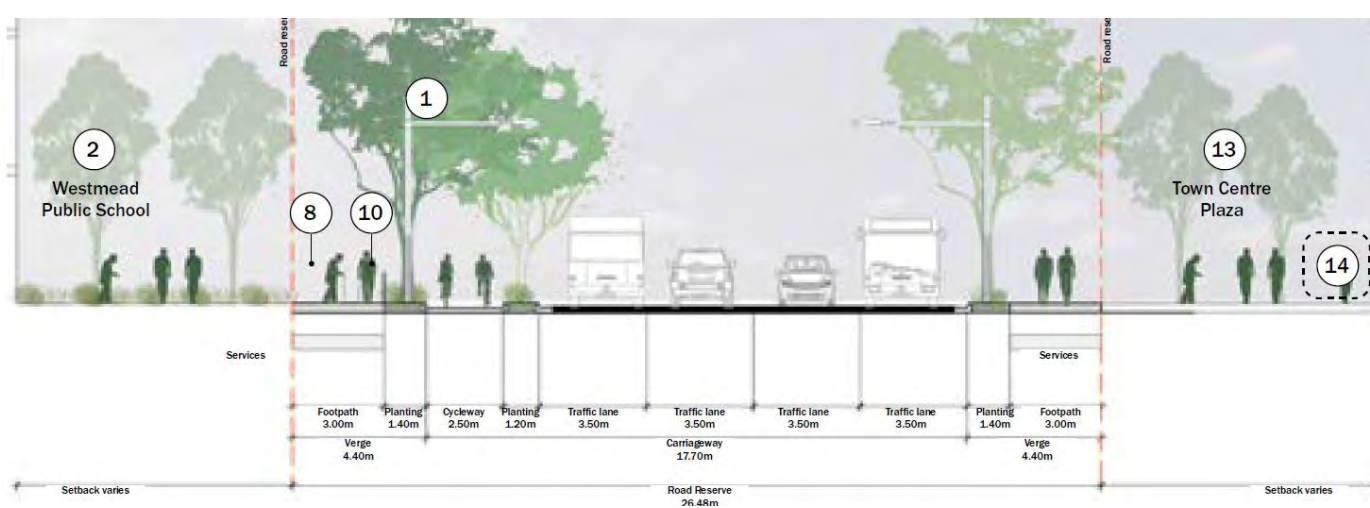
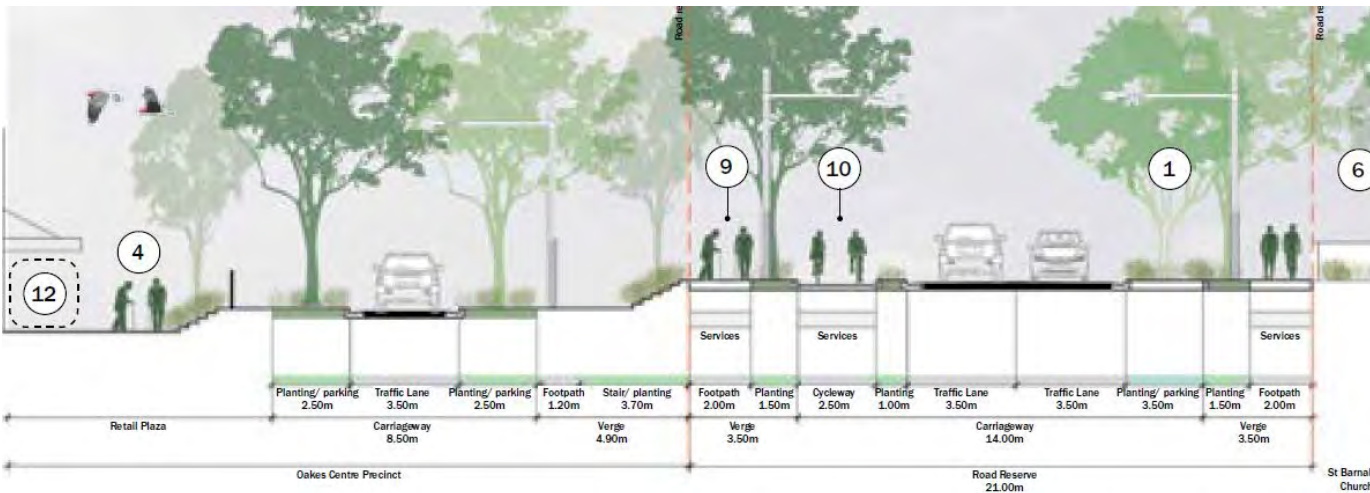

Figure 2-12 Pedestrian and Cycle Network

Town Centre 2, Alexandra Avenue to Mowie Street



Neighbourhood 3, Mowie Street to Cotswald Street



Neighbourhood 4, Cotswald Street to Great Western Highway

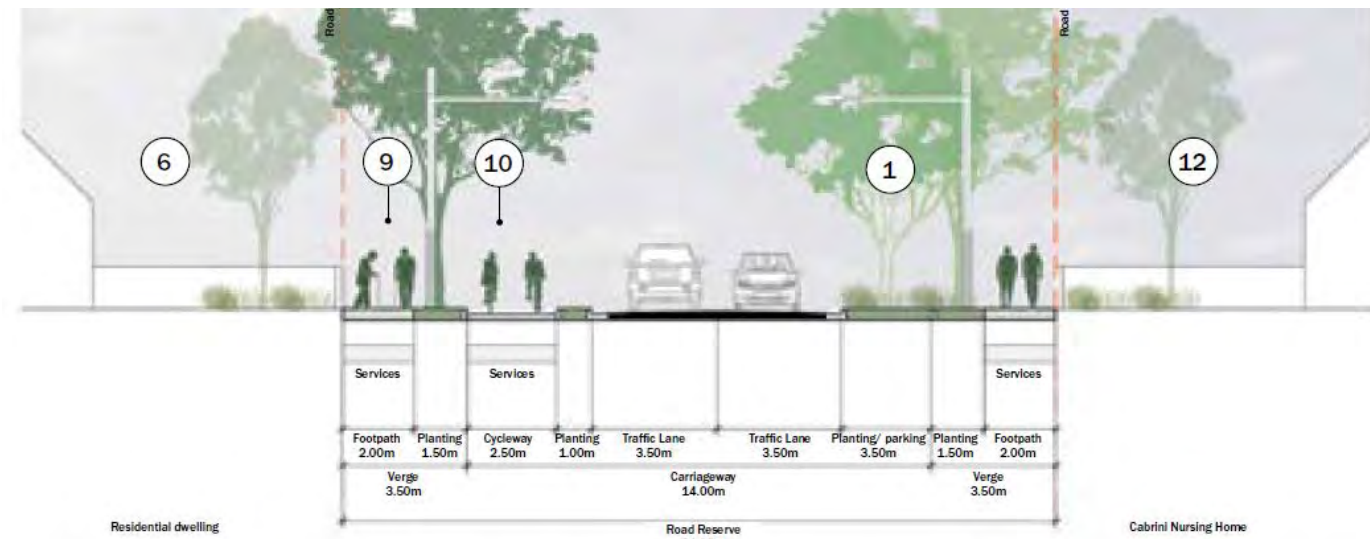

Figure 2-13 Hawkesbury Road cross sections

2.1.9 Sydney Metro West

Sydney Metro West is a new 24-kilometre metro line with stations confirmed at Westmead, Parramatta, Sydney Olympic Park, North Strathfield, Burwood North, Five Dock, The Bays, Pyrmont and Hunter Street in the Sydney CBD.

Sydney Metro West will deliver:

- Faster, more frequent access to major employment and education centres like Parramatta and Sydney Olympic Park.
- A new metro station in the heart of the Sydney CBD commercial centre, connecting directly to Sydney’s established and growing employment precincts.
- A new metro station at Westmead – one of Australia’s largest health and education precincts.
- Delivering new rail services for the first time at Burwood North, Five Dock, The Bays and Pyrmont.
- A new metro station at Sydney Olympic Park – Sydney’s sporting and entertainment super-precinct.
- A new metro station at Pyrmont – delivering major benefits to the Pyrmont community and supporting plans to transform this harbourside suburb.
- Integrated with the rest of Sydney’s public transport system.
- Fully accessible with lifts and level access between trains and platforms.

The layout of the Westmead station interchange is provided in **Figure 2-14**. The primary station entrance will be on Hawkesbury Road. Bus interchange will be provided on Alexandra Avenue.

Figure 2-14 Westmead Metro Station interchange

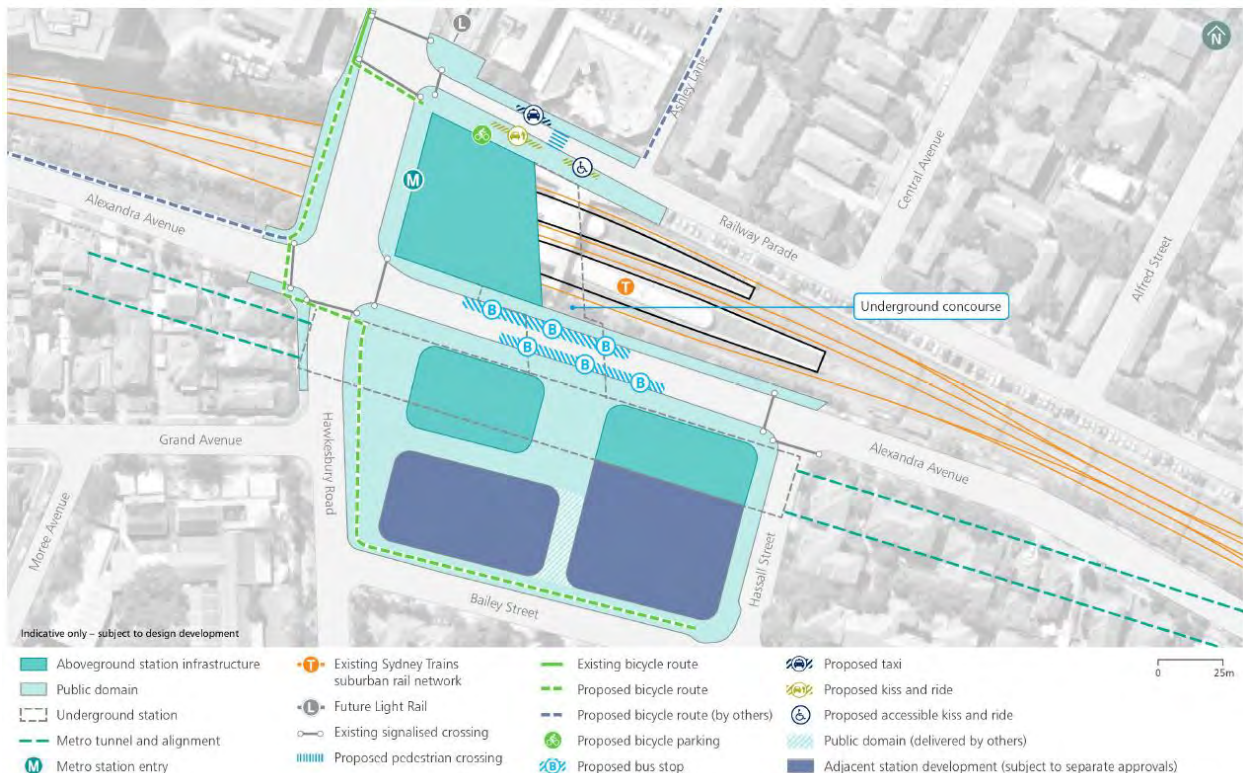

Source: Sydney Metro, 2022

Footpath widening or upgrade is proposed by Sydney Metro in the following locations around the precinct:

- Southern side of Railway Parade
- Both sides of Hawkesbury Road bridge
- Both sides of Alexandra Avenue, between Hassall Street and Hawkesbury Road

- Upgrades to footpaths in the block bound by Hawkesbury Road, Alexandra Avenue, Bailey Street and Hassall Street.

Station passenger demand was forecast for the 2036 AM peak hour. The demand indicates approximately 3,000 customers accessing the station and 3,300 customers exiting, with nearly 3,000 customers transferring services between Sydney Metro and suburban rail services. A summary of the pedestrian flows is provided in **Figure 2-15**.

Figure 2-15 Westmead future pedestrian volumes

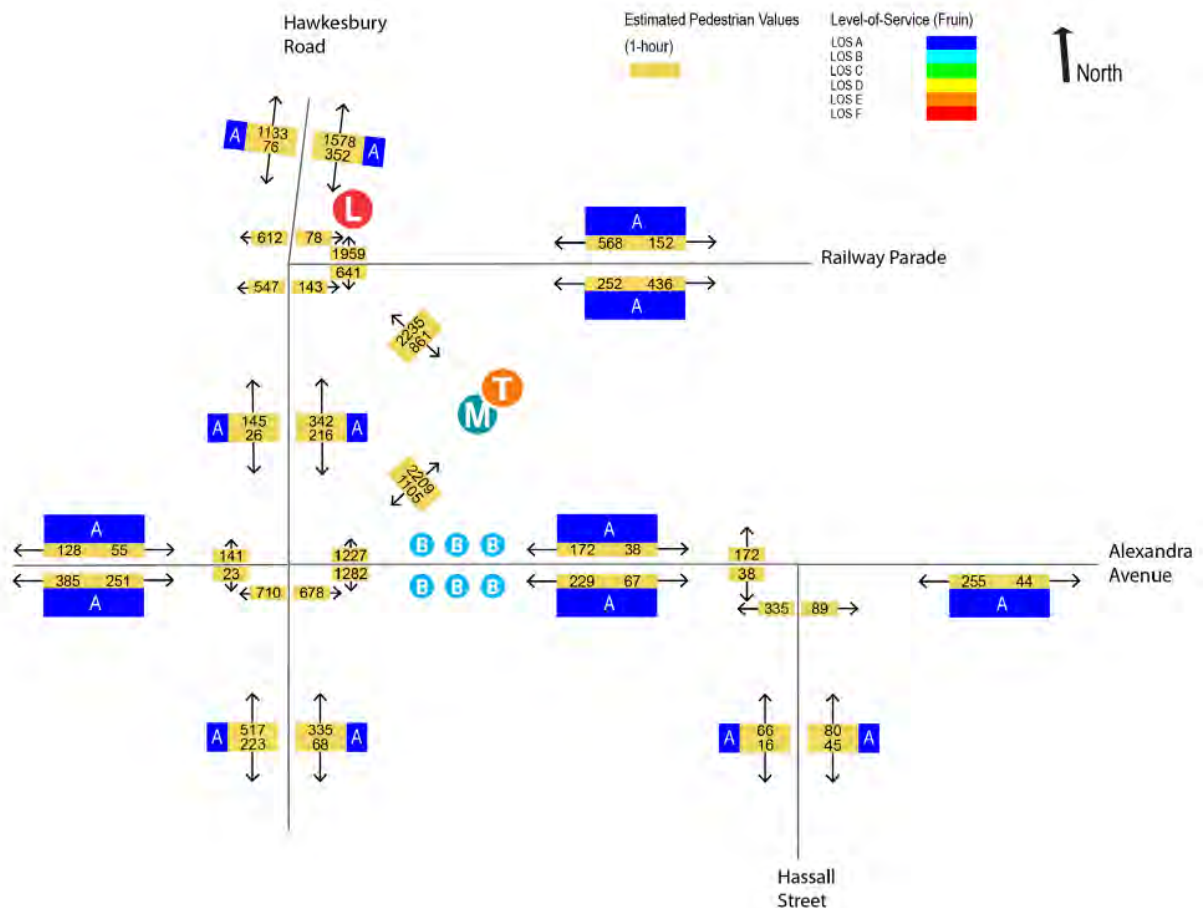

Source: TfNSW, 2022

Traffic modelling of the intersections outside of the Metro Station was conducted (**Figure 2-16**).

Figure 2-16 Intersection performance with Sydney Metro West

Intersection	AM Peak				PM Peak			
	Without Sydney Metro West		With Sydney Metro West		Without Sydney Metro West		With Sydney Metro West	
	Average delay (s)	LOS	Average delay (s)	LOS	Average delay (s)	LOS	Average delay (s)	LOS
Hawkesbury Road / Railway Parade	25	B	47	D	64	E	42	C
Hawkesbury Road / Alexandra Avenue	171	F	339	F	44	D	46	D
Alexandra Avenue / Hassall Street	98	F	135	F	17	B	20	B

Source: TfNSW, 2022

Implications for Westmead South

Sydney Metro West will generate substantial pedestrian demands on the footpath network along Hawkesbury Road. As there are limited north-south pedestrian corridors, pedestrians will naturally use Hawkesbury Road as the primary strategic route. This aligns with planning for the Westmead 2036 Place Strategy, which has Hawkesbury Road as the spine pedestrian road.

Demands are nonetheless lower than expected towards Westmead South, likely as the modelling for Sydney Metro West did not account for the proposed uplift in this project.

The intersection performance at Hawkesbury Road around the station performs with significant delays. It should not be expected that these intersections could accept any increase in traffic associated with the Westmead South precinct, as the environment is constrained due to the rail interface and light rail to the north.

2.1.10 Parramatta Light Rail Stage 1

Parramatta Light Rail Stage 1 is currently under construction and will provide:

- High-frequency 'turn-up-and-go' light rail services seven days a week, departing approximately every 7.5 minutes in peak periods.
- Modern and comfortable air-conditioned vehicles, 45 metres long, driver-operated and integrated with the Opal card network.
- Two new light rail and pedestrian zones along Church and Macquarie Streets in the Parramatta CBD.
- The Parramatta Light Rail will replace the train line between Camellia and Carlingford, which will provide more frequent services and better connections to town centres, including Parramatta and Sydney CBD.
- A new Active Transport Link (shared walking and bike riding path) between Carlingford and Parramatta.

By 2026, around 28,000 people are expected to use the Parramatta Light Rail every day, with an estimated 130,000 people living within walking distance of the 16 light rail stops.

2.2 Cumberland City Council

2.2.1 Cumberland 2030: Our Local Strategic Planning Statement

The *Cumberland 2030: Our Local Strategic Planning Statement* (LSPS) document is a Local Strategic Planning Statement that plans for the Cumberland Local Government Area's economic, social, and environmental land use needs over the next 10 years and is aligned with the 20-year vision for Cumberland City. It sets clear planning priorities about what will be needed in the future, including jobs, homes, services, and parks.

The structure plan outlined in the LSPS provides an integrated approach as Cumberland City grows and evolves, including land use, infrastructure, environment and culture and aligns with the regional and district strategic directions outlined in the Greater Sydney Region Plan and Central City District Plans.

The LSPS recognises the importance of key centres in the Cumberland LGA as places with high levels of accessibility offering opportunities for growth in local jobs and housing. A framework of centres has been identified to support the land use vision for the Cumberland LGA as listed below:

- Merrylands as the proposed strategic centre for Cumberland, providing higher order services and facilities to meet the needs of the Cumberland area and complementing the role of Greater Parramatta
- Principal local centres at Auburn, Granville, Lidcombe and Wentworthville, providing services and facilities to meet the needs of the broader local community
- Strategic precinct at Westmead, providing a specialised health and education role for Cumberland and the Greater Parramatta areas
- Local centres at Berala, Greystanes, Guildford, Merrylands East, Merrylands West, Pemulwuy, Pendle Hill, Toongabbie and Regents Park, provide services and facilities to meet the needs of each local community
- A range of neighbourhood centres across the Cumberland area provides targeted services and facilities.

A key action is expanding the Green Grid link connecting Westmead town centre to Pemulwuy Reserve near Parramatta Park through collaboration with the City of Parramatta and the Parramatta Park Trust's 'Mays Hill Precinct Master Plan 2017' by improving urban tree canopy cover and pedestrian and cycle path.

Key overall considerations outlined in the LSPS that will be considered in this study include:

- **Improving urban amenity** and applying pedestrian safety design to mitigate high traffic volumes on major road networks such as Great Western Highway and Hawkesbury Road
- Several natural and built features throughout the area act as **barriers to car, cycling and pedestrian movements**. These include the M4, Parramatta Road / Great Western Highway and the Main Western Train Line in an east-west direction, and the Cumberland Highway, A6, Cumberland Train Line and the Duck River in a north-south direction
- **Various crossings** are located along the railway lines and major roads to connect different parts of Cumberland, although the **distances between them** can sometimes be significant, particularly for pedestrians and cyclists.

The LSPS' structure plan (**Figure 2-19**) highlights several routes of future importance to the Cumberland LGA. These include the identified strategic corridors Greater Parramatta to Olympic Park (GPOP) Economic Corridor (the Transitway Liverpool to Parramatta corridor and the Parramatta Road corridor) and the Green Grid corridors along the Duck River corridor and the Prospect Pipeline corridor.

Figure 2-19 The Cumberland LGA Structure Plan



Source: Cumberland City LSPS

Implications for Westmead South
 Council is advocating for a link to Western Sydney Airport that interfaces with Westmead and Parramatta, which would support public transport uptake.

2.2.2 The Open Space and Recreation Strategy

The Open Space and Recreation Strategy 2019 to 2029 provides Council with a ten-year direction for open space, sport and recreation services and facilities. The Strategy's guiding principles, strategic directions and actions focus on achieving social inclusion, connectivity, health and well-being, increased sport and recreation participation and social and environmental sustainability within Cumberland. The Strategy has four strategic directions:

- Deliver new open space and new recreation facilities that meet the needs of our growing population.
- Increasing the quality and capacity of existing open space and recreation facilities.
- Supporting inclusion and increased participation by our diverse community.
- Protecting our natural environment and increasing resilience.

The Strategy states that regardless of the amount of open space there may be in a particular area, if it is not easy to get to, it is not likely to be used. This is why it is important to plan for open space by considering both the amount of open space, as well as how people can access it. **Figure 2-20** shows walking catchments of 400m from all parks over 0.5ha in Cumberland LGA. It shows that not all residents have access to parks and that parks are not evenly distributed.

In these areas, priorities to improve access should include:

- expanding the size of existing open space (e.g. through the acquisition of adjoining sites)
- improving pedestrian access to existing open space (e.g. through active street networks or connecting up existing parks)
- creating a network of smaller spaces that provide a range of recreation functions with active street connections between them.

Figure 2-20 Walking catchments from all parks over 0.5ha in the Cumberland LGA

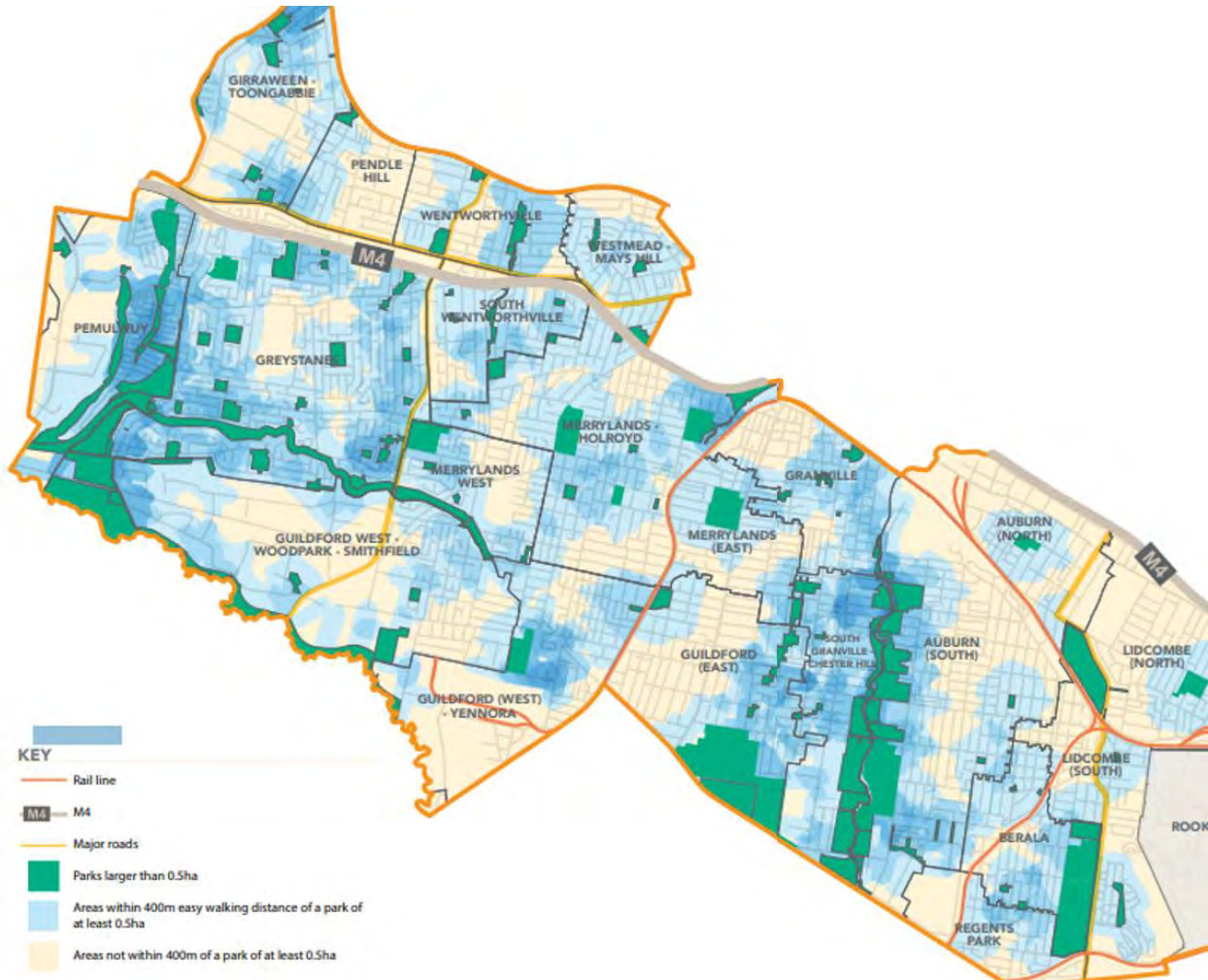

Source: The Open Space and Recreation Strategy 2019 to 2029 (Cumberland City Council)

Specific actions in the Strategy relating to pedestrian and access improvements include:

- **Action 1.1.1:** Develop an Open Space Acquisitions Strategy that includes areas that currently have the lowest provision open space per person or that are not within 400m of open space of at least 0.5ha, with a focus on expanding existing assets, improving connections to existing open space, and providing spaces for new recreation facilities.
- **Action 1.1.3:** Investigate opportunities for new civic space to be provided in line with place-making strategies in town centres through pedestrianised laneways, pocket parks/plazas, building forecourts in new community facilities, footpath widening, seating nooks and street closures.
- **Action 2.4.1:** Work with regional partners including neighbouring councils and the State government to implement the principles and priority projects of the Sydney Green Grid, specifically the Duck River Open Space Corridor, Prospect Reservoir Water Pipeline Corridor and Duck Creek projects.
- **Action 2.4.2:** Investigate opportunities to increase access to open space through:
 - o an active street network in areas with poor distribution of open space, and
 - o new links through / between adjoining parks, particularly along creek lines.

Implications for Westmead South

Walking and cycling connectivity needs to be oriented not just towards employment, retail and transit hubs but also towards open space.

2.2.3 Walking and Cycling Strategy

Council’s Walking and Cycling Strategy evaluates the different influencing factors on why residents would walk and cycle and concludes that “there is more work to do to create a better supported and interconnected network of walking and cycling paths, but that there are a number of existing walking and cycling paths for residents and visitor to enjoy”. This is borne out by the cycle network mapping, which shows that there are a number of routes, but they don’t always integrate well with the centres – Westmead is a noticeable gap.

Figure 2-21 Cycling network in Cumberland City

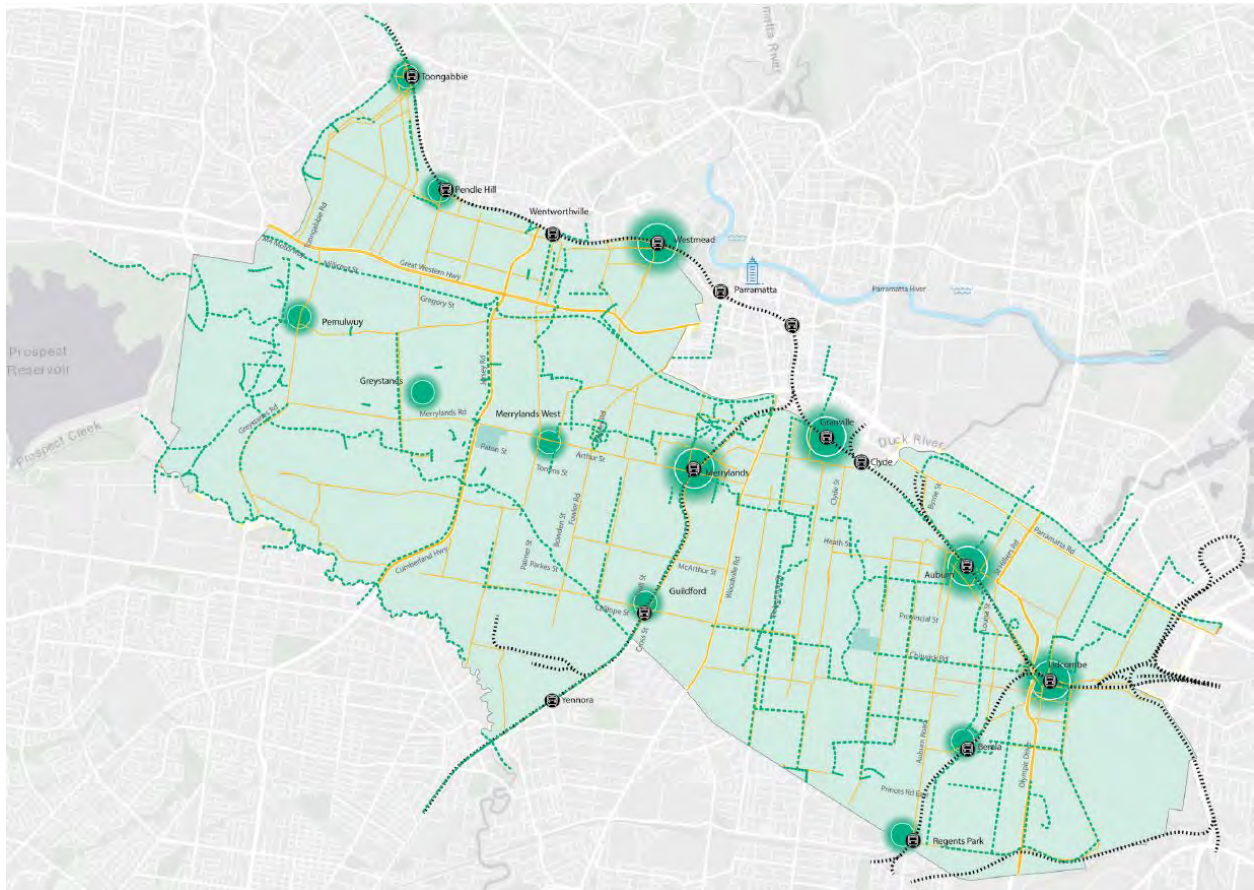

Source: Cumberland City Council, 2023

Figure 2-22 Active transport corridors in Cumberland City

Cumberland Active Transport Corridors

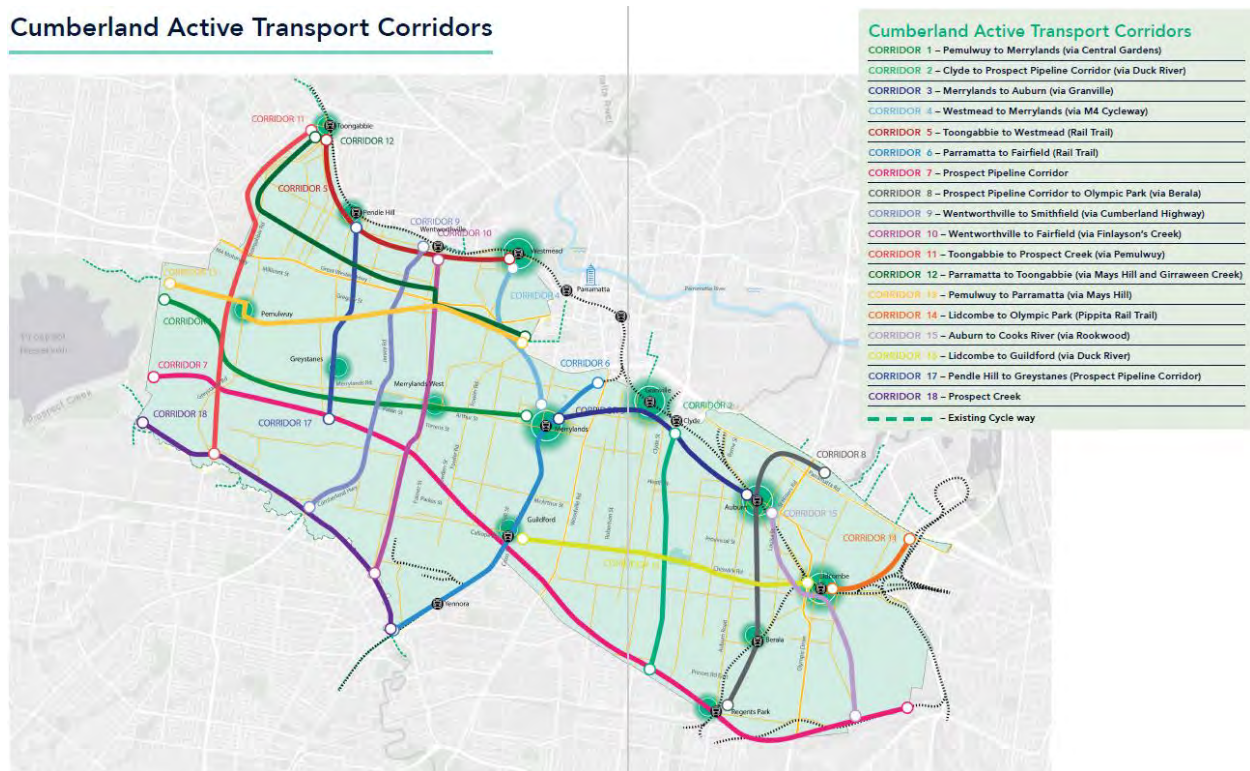

Source: Cumberland City Council, 2024

Corridor 4 – Westmead to Merrylands (via M4 Cycleway) is considered partially completed.

Implications for Westmead South

North-south connectivity for walking and cycling is important as it aligns with Council's network-wide objectives.

2.2.4 Westmead South Centre Traffic and Transport Study (2022)

SCT Consulting prepared a Traffic and Transport Study (2022) to accompany the concept land use plan for Westmead South. It analysed the existing travel behaviours and found that while non-car mode share was relatively high, car mode share was still significant (44% for residents and 57% for workers).

The following intersections were modelled to understand the impacts of the concept land use:

- Hawkesbury Road / Alexandra Avenue
- Hawkesbury Road / Priddle Street
- Hawkesbury Road / Amos Street
- Hawkesbury Road / Great Western Highway (GWH)
- Bridge Road / Great Western Highway (GWH)

A traffic generation rate of 0.19 trips per unit was adopted. The total trip generation for each scenario was as follows:

- Current: 250 (1,317 dwellings)
- Low density: 677 (4,881 dwellings)
- Medium density: 1,098 (7,094 dwellings)
- High density: 1,742 (10,484 dwellings).

Widening was identified as required along Great Western Highway at Hawkesbury Road and Bridge Road intersections. In the low density scenario, Hawkesbury Road / Great Western Highway required an additional left turn

lane (Figure 2-23). For the medium and high density scenarios, widening along Great Western Highway is required (Figure 2-24).

Figure 2-23 Low density scenario upgrade required

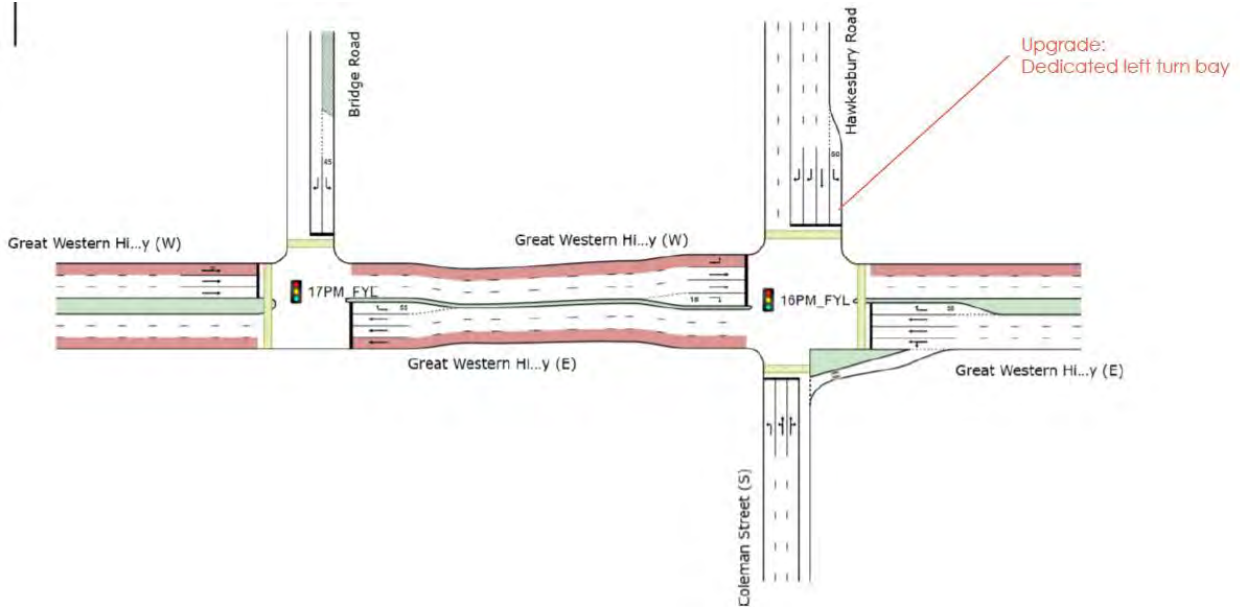

Source: SCT Consulting, 2022

Figure 2-24 Medium and high density scenarios upgrades required

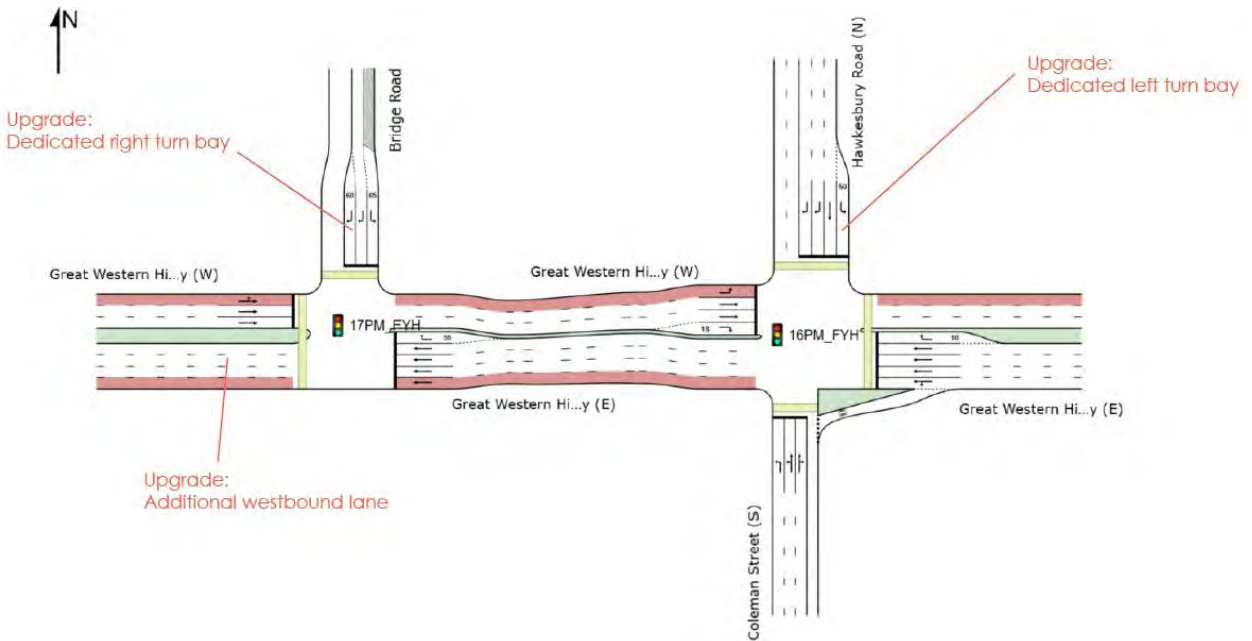

Source: SCT Consulting, 2022

Implications for Westmead South

This study provides a first cut of the type of upgrades that could be triggered by the development. The scale of upgrades needs to be refined in this study, particularly considering the potential for higher non-car mode share.

2.3 City of Parramatta

2.3.1 City of Parramatta draft Bike Plan 2023

City of Parramatta has delivered a substantial network of bicycle infrastructure based on its 2017 Bike Plan. This study used cycling propensity mapping to refine potential locations for cycle routes. Council has progressively extended the regional cycling network in their LGA since publication, for example along the M4 cycleway and the Parramatta Valley Cycleway.

The proposed network plan is provided in **Figure 2-25**.

The Bike Plan shows the area around Westmead as having an abundance of cycling options, including east-west on road routes and some north south off-road shared paths. There is an expectation by City of Parramatta that Cumberland City Council will provide some east-west connectivity: on-road separated and off-road shared path along Alexandra Avenue.

Parramatta Light Rail has constrained some of the road network around Westmead and so some of the proposals are no longer likely to be possible.

Implications for Westmead South

City of Parramatta is strengthening east-west and north-south connectivity around Westmead, creating opportunities for future cycling links in Westmead south to connect into.

Figure 15:
Future Parramatta
Bicycle Network
(Central)

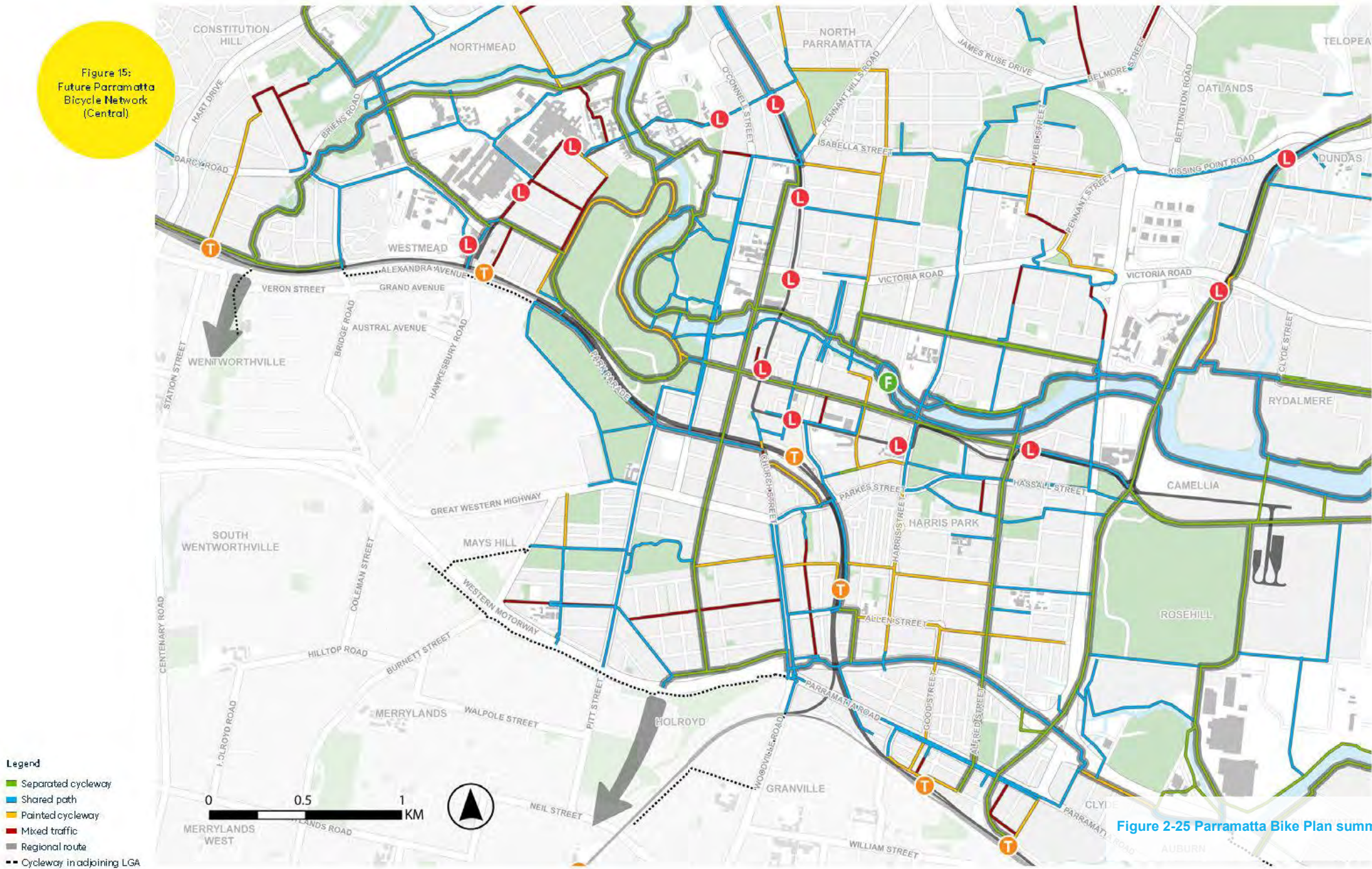

Figure 2-25 Parramatta Bike Plan summary

2.3.2 Mays Hill Precinct Master Plan

Mays Hill is a precinct within Parramatta Park. It sits slightly isolated from the remainder of Parramatta Park due to the segregation caused by rail corridor. The master plan for the precinct is shown in **Figure 2-26**.

Figure 2-26 Mays Hill master plan



The park will cater for increased recreational activities, including some playing fields, an aquatic centre and more play spaces. The design also proposed a potential landbridge connection over the railway.

Implications for Westmead South

The upgrade of the park makes the connections through to Parramatta CBD more attractive by providing high amenity connections. It also will be an important recreation destination and therefore needs to be connected into the Westmead South precinct seamlessly.

3.0 Existing conditions

3.1 Context

Westmead South is situated with Parramatta CBD to the east and the Westmead Health and Innovation District to the north.

Parramatta CBD considered Sydney's Central City. It caters for a mix of commercial, residential, and retail offerings. In the 2022 estimated residential population was 15,211 residents and approximately 81,900⁴ jobs.

Located between Westmead South and Parramatta CBD is Parramatta Park and the Mays Hill Precinct. It has important sporting grounds as well as heritage buildings.

According to the Place Strategy, the Health and Innovation District has Australia's largest concentration of hospital and health services. By 2036 it could cater for up to 50,000 jobs.

Westmead South is home to two schools: Westmead Public School and Sacred Heart Catholic Primary School. It also has several local public open spaces, including the M J Bale Park.

The points of interest around the precinct are shown in **Figure 3-1**.



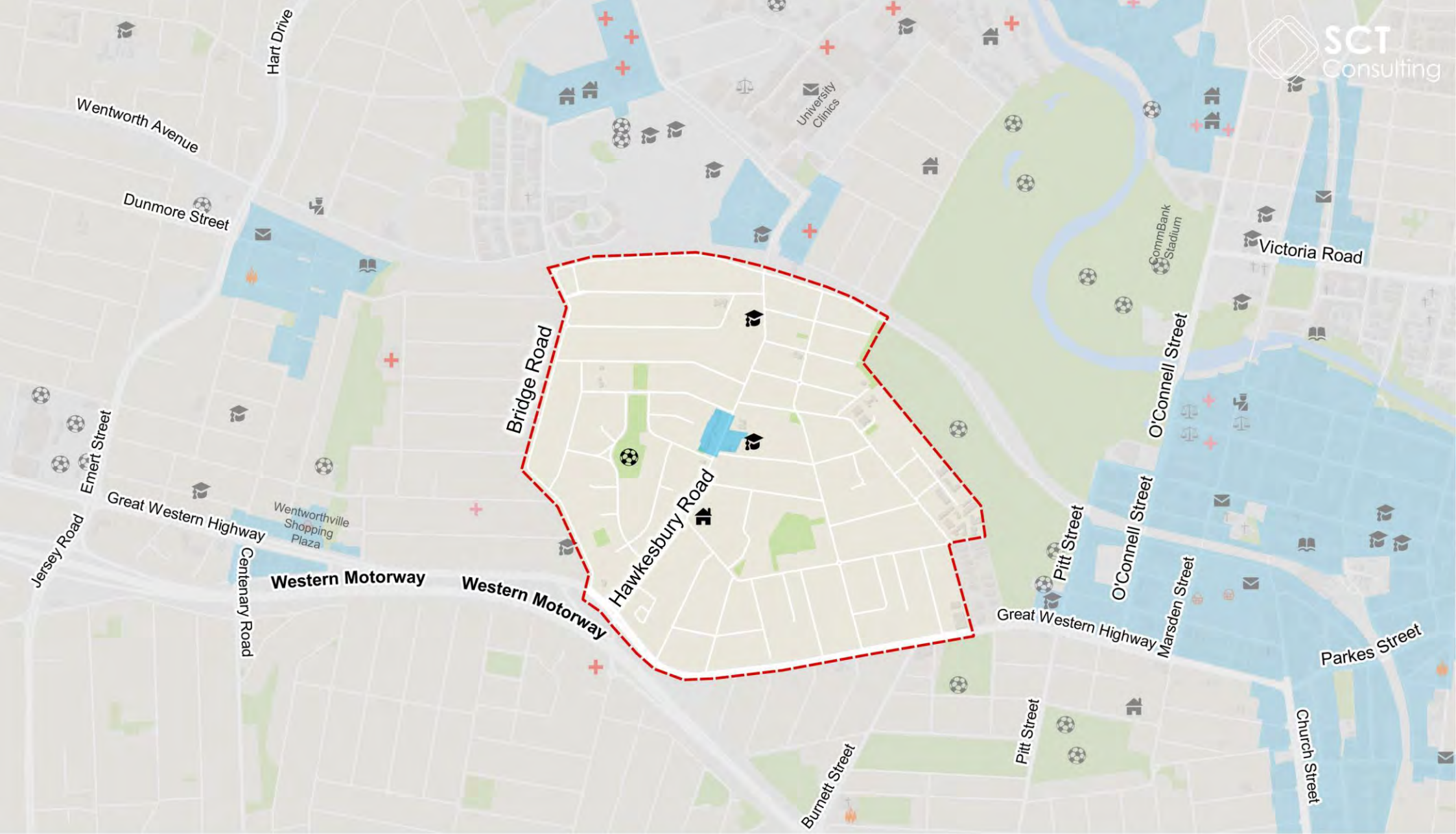

⁴ <https://greatercities.au/central-city-district-plan/productivity/jobs-and-skills-city/growing-stronger-and-more-competitive>



Legend

- - - Study area
- Commercial / Mixed use

Point of interest

-  Aged care / retirement
-  Child care centre
-  Community medical centre
-  Court house
-  Emergency services

-  Hospital
-  Library
-  Police station
-  Post office
-  School
-  Shopping centre
-  Sport facility

Figure 3-1 Site context

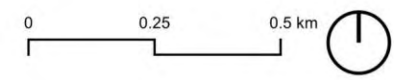

3.2 Travel behaviours

3.2.1 All day mode share

The all-day mode share is derived from the Household Travel Survey (HTS). As the sample size is smaller for the HTS compared to the Australian Census, the results may only be reported to the SA3 of Local Government Area geographic area, which is much larger than the study area (**Figure 3-2**). Results, therefore, should be reviewed carefully.

Figure 3-2 Parramatta SA3 (2016 geography)

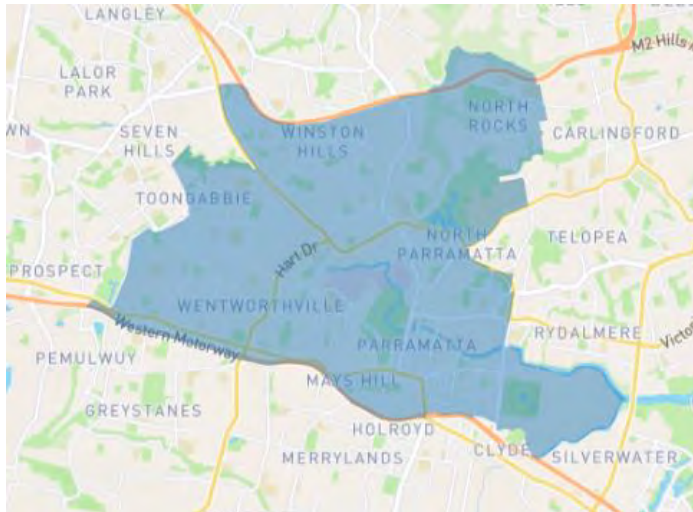

Source: Transport for NSW, 2023

HTS results for 2016/17 and 2019/20 are provided in **Table 3-1**.

Table 3-1 Household Travel Survey results for SA3 “Parramatta”

Travel mode	2016/17			2019/20			Mode shift 2016/17 – 2019/20
	% total trips	Mode share	Average distance	% total trips	Mode share	Average distance	
Vehicle driver	34.5%	42.5%	9.8 km	33.1%	39.9%	9.0 km	-2.6%
Vehicle passenger	15.2%	18.8%	5.8 km	16.4%	19.8%	6.2 km	+1.0%
Train	6.6%	8.2%	18.4 km	6.1%	7.4%	20.9 km	+0.8%
Bus	6.0%	7.4%	11.9 km	6.4%	7.7%	10.3 km	-0.3%
Walk only	17.4%	21.5%	0.8 km	18.2%	22.0%	0.7 km	+0.5%
Walk linked	18.8%	-	0.7 km	17.2%	-	0.6 km	-
Other	1.4%	1.7%	2.2 km	2.6%	3.2%	1.9 km	+1.5%

Source: Transport for NSW, 2023

The other category is likely best explained by an increase in cycling and e-mobility (such as electric scooters). The overall trend is generally in the direction of sustainable travel, with increases in walking, carpooling, public transport use, and cycling/e-mobility.

3.2.2 Travel to work mode share

The method of travel to work data is collected every five years as part of the Australian Government’s Census. As the 2021 census coincided with a COVID-19 lockdown, the method of travel to work data is assumed to be unreliable as an indicator of typical travel behaviours. 2016 data is reported in this section as a result.

The method of travel to work is shown in **Table 3-2** and **Figure 3-3**.

Table 3-2 Detailed method of travel to work mode share (2016)

Travel mode	Westmead - Mays Hill
Train	35.1%
Bus	5.2%
Car - as driver	40.6%
Car - as passenger	3.8%
Truck	0.5%
Motorbike	0.0%
Bicycle	0.1%
Walked only	4.8%
Other	0.8%
Worked at home	3.3%
Did not go to work	5.4%
Not stated	0.4%

Figure 3-3 Summary of method of travel to work mode share (2016)

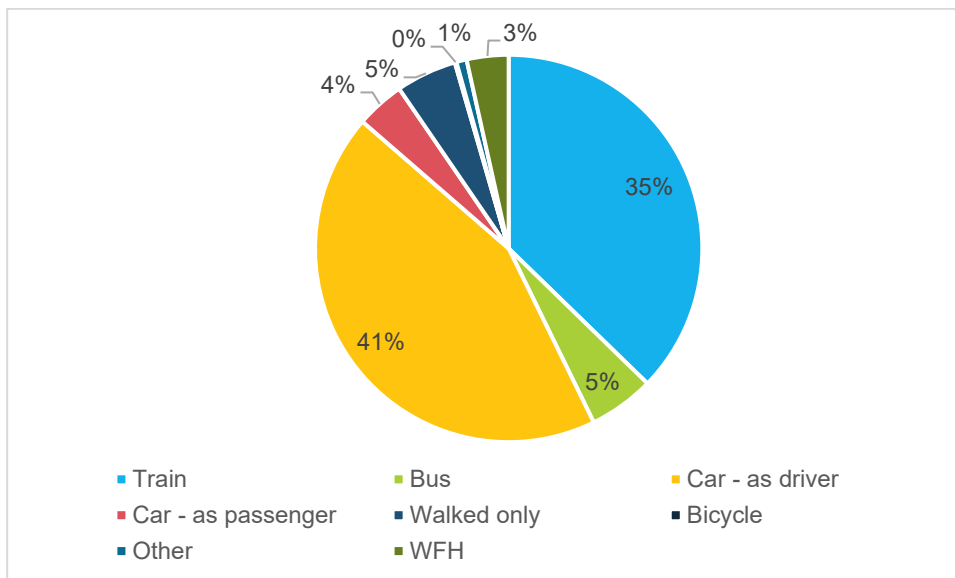

Source: Australian Bureau of Statistics, 2016

The data show that in 2016, work from home accounted for 3.3 per cent of all travel. Car – as driver was the dominant mode of choice, accounting for 41 per cent of all travel.

With eight years passing since the original census, many factors are expected to be different today. For example, the NSW Innovation and Productivity Council forecast that work from home will settle at around 30 per cent of total work for ‘remotable workers’ (**Figure 3-4**).

Figure 3-4 Forecast proportion of working from home (NSW Innovation and Productivity Council)

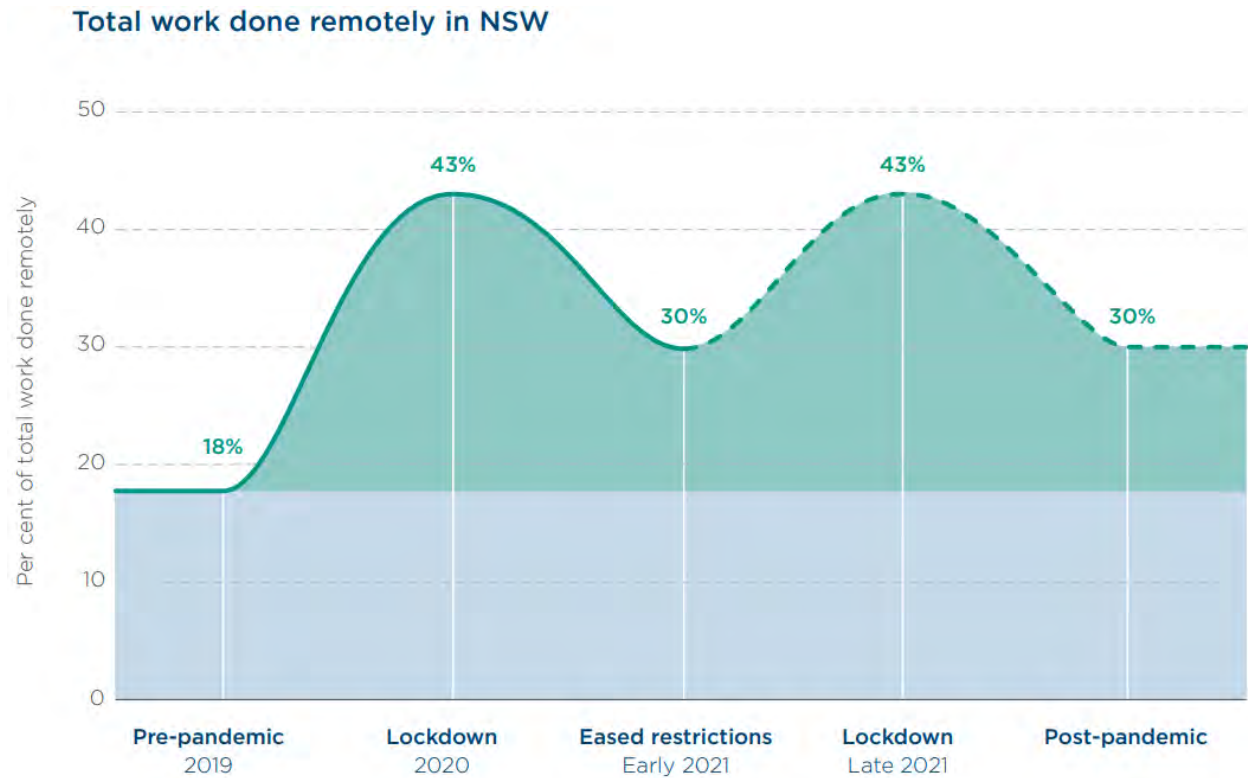

Source: NSW Innovation and Productivity Council, 2021

Overall, hybrid working arrangements are predicted to be the long term new way of working.

Parramatta CBD has also experienced significant redevelopment since the time of the census, with major increases in commercial floor space. As a result, Parramatta CBD is likely to be more attractive as a working location. Also, Westmead Hospital has undergone a major redevelopment, with approximately 30 per cent of the hospital being upgraded between 2017 and 2022⁵.

As result, walking only and cycling/e-mobility trips are expected to be a greater share than in 2016. This is consistent with the results of the HTS analysis, which showed an increase in these modes (**Section 3.2.1**)

3.3 Road

The road network comprises several key road corridors:

- **Great Western Highway:** a classified State Road, which is posted at 60 km/h and arterial in function. It has dedicated bus lanes in both directions. It has three lanes in each direction within the study area plus turning lanes at major intersections. Parking is restricted by 24-hour clearways.
- **Hawkesbury Road:** a local road which is posted at 50km/h, except around Westmead Public School, which has school zone speed limits of 40km/h. It is a collector/distributor road in function, with between one and two traffic lanes in each direction. There is intermittent designated on-street parking along its length, which is generally unrestricted except for the northern section, which has time restrictions of 2P with permit exceptions.
- **Bridge Road:** a local road which is posted at 50km/h, except around Westmead Christian Grammar School (located west of the study area) at the southern end, which has school zone speed limits of 40km/h. It is a collector/distributor road in function, with generally one lane in each direction, except for the southern end, which has a short two lane section approaching Great Western Highway. There is intermittent designated on-street parking which is unrestricted.

Road hierarchy is shown in **Figure 3-5**, speed limits in **Figure 3-6** and crash history in **Figure 3-7**.

⁵ <https://www.nsw.gov.au/westmead-redevelopment>

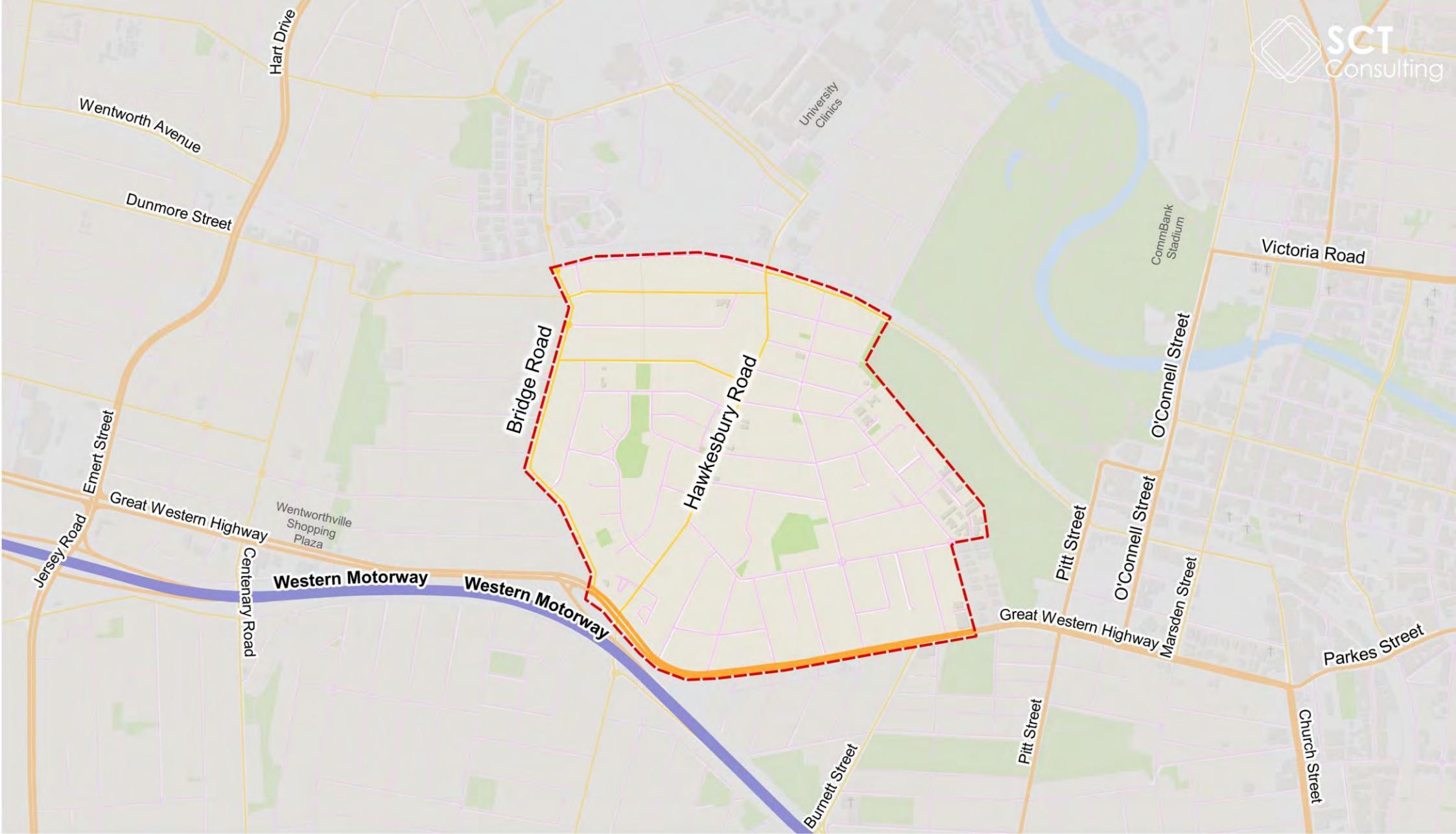

Legend
 - - - Study area

Road hierarchy

- Motorway
- Arterial
- Distributor
- Local
- Access path

Figure 3-5 Road hierarchy



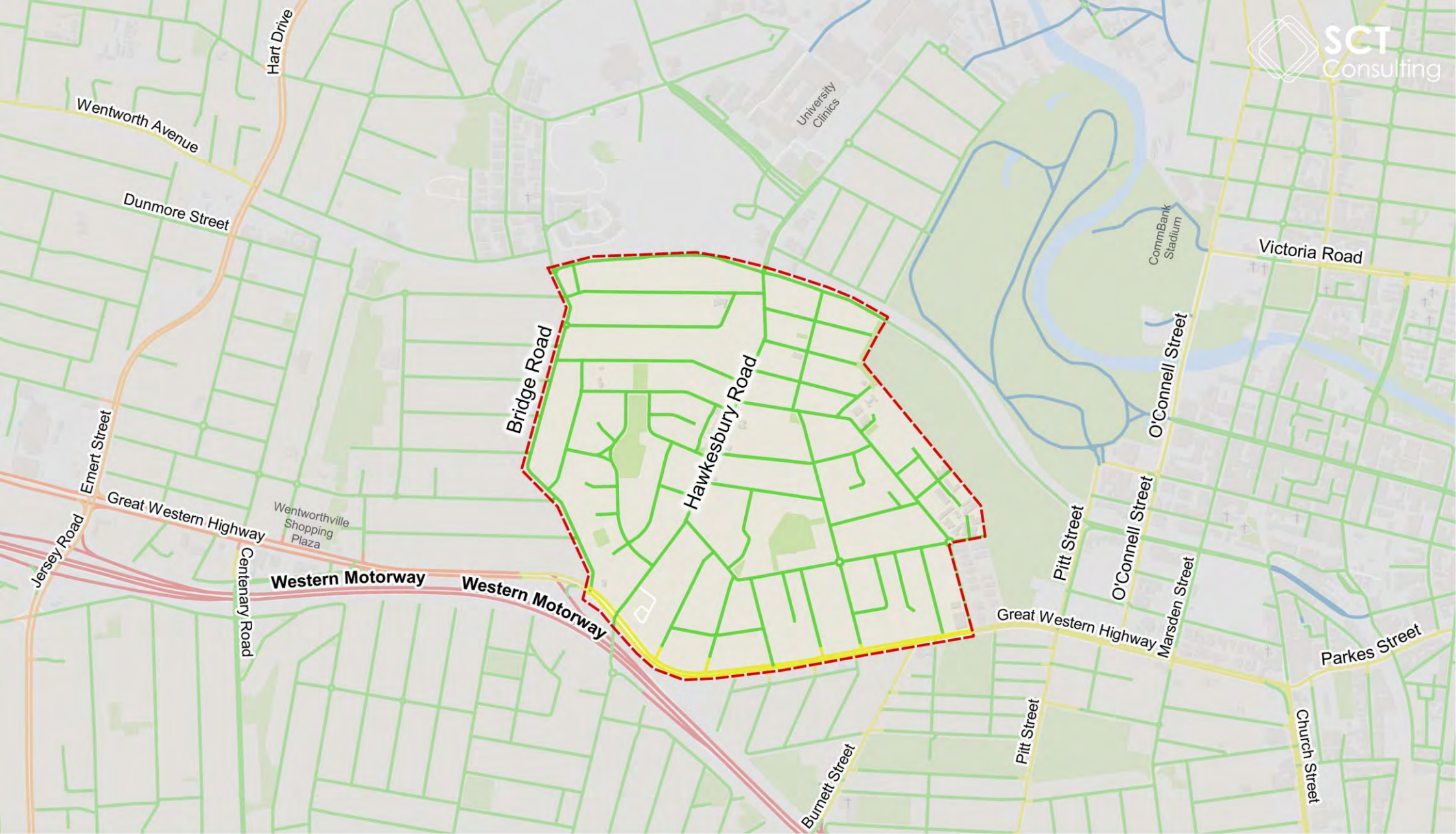

Legend

- - - Study area

Road speed

- | | | | |
|--|-------------|--|-----------|
| | 10-30 km/hr | | 80 km/hr |
| | 40-50 km/hr | | 90 km/hr |
| | 60 km/hr | | 100 km/hr |
| | 70 km/hr | | |

Figure 3-6 Road speed limits

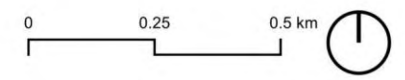

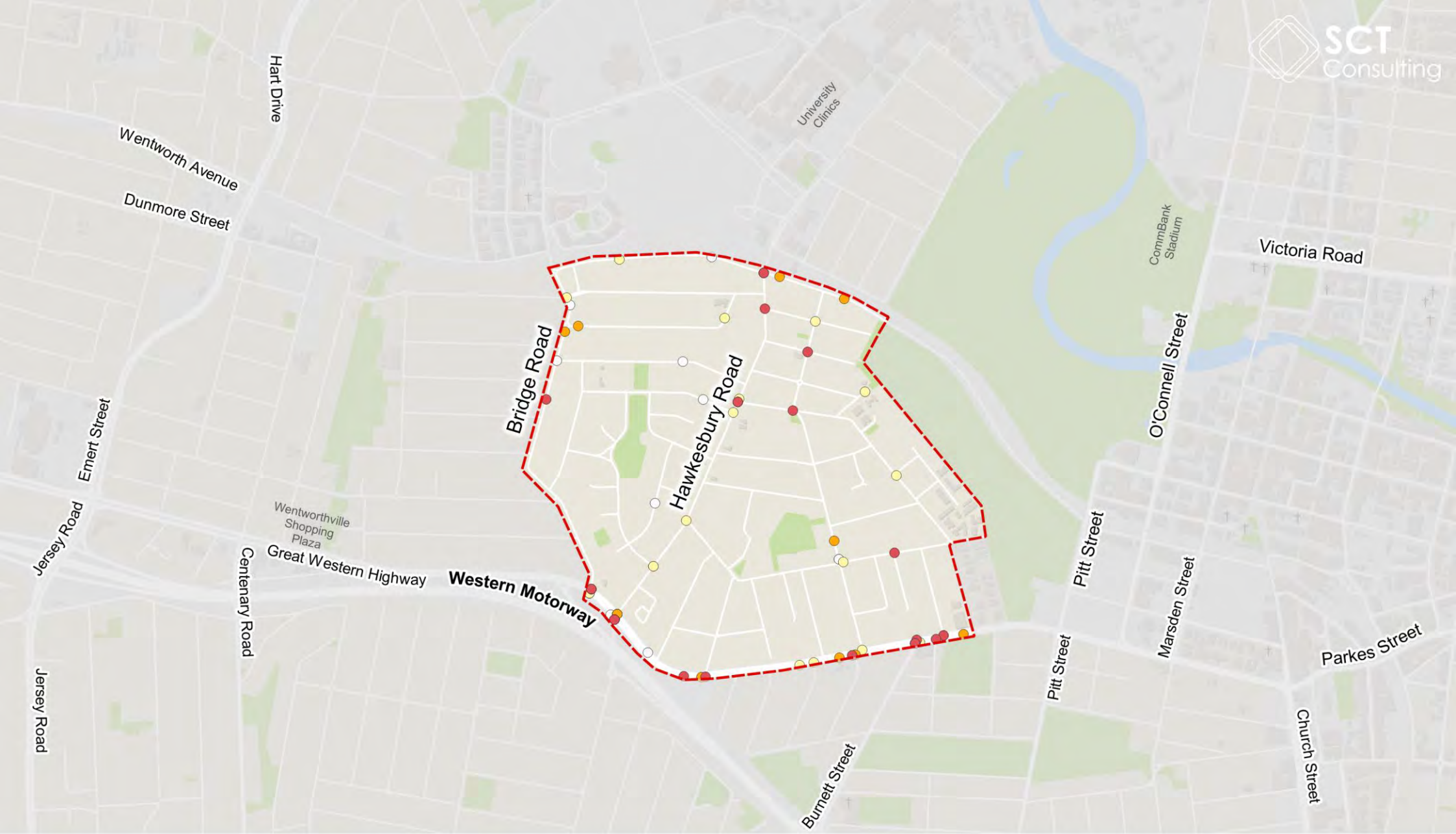

Legend
 - - - Study area

Crash severity (all crash types)

- Fatality
- Serious injury
- Moderate injury
- Minor/other injury
- Non-casualty (towaway)

Figure 3-7 Crash history

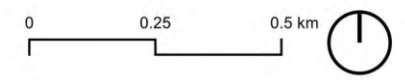

The crash history shows a pattern of crashes focussed on the more significant road corridors, particularly Great Western Highway, Bridge Road, Hawkesbury Road and Houison Road all have some history of incidents as well.

Traffic modelling conducted (refer details in Section 7.0) shows that route travel times are at levels fairly typical for urban networks, but Bridge Road southbound operates with slow speeds in the evening peak southbound – 8km/h. Hawkesbury Road operates at 17-25km/h, which is reflective of delays occurring at intersections. Great Western Highway operates at 36-43km/h, which reflects reasonably fast travel times. This is likely associated with phase timings which allocate more time to Great Western Highway than the approaches from Hawkesbury Road, Bridge Road and Coleman Street. The results for travel times are summarised in **Table 3-3**. Detailed results are available in **Appendix B**.

Table 3-3 Traffic modelling performance of key road networks

Hawkesbury Road speed			Great Western Highway speed			Bridge Road speed		
	AM	PM		AM	PM		AM	PM
Northbound	21km/h	25km/h	Eastbound	43km/h	40km/h	Northbound	28km/h	27km/h
Southbound	23km/h	21km/h	Westbound	37km/h	36km/h	Southbound	32km/h	19km/h

3.4 Parking

Parking surveys were conducted on Wednesday 24 May 2023 from 6am to 6pm at three hourly intervals. Data was collected for every street in the study area and mapped. Parking occupancies and restrictions are provided in **Appendix A**.

The study area is generally divided into two categories of restrictions:

1. Unrestricted parking
2. 2P parking from 8.30am to 6pm weekdays and 8.30-12.30pm Saturday.

The unrestricted parking region is in the south-western portion of the study area, bounded by Church Avenue-Pye Street and Houison Street. The 2P restricted parking area is the remaining north-eastern portion. The restrictions generally align with density and proximity to Parramatta CBD / Westmead Innovation District. One notable exception is Alexandra Avenue, northern side, from Bridge Road to Hawkesbury Road which is in the 2P portion of the study area but is unrestricted instead.

Parking occupancy is generally 0-80%, except for:

- **Alexandra Avenue northern side:** this portion of Alexandra acts as an informal park 'n ride area due to its proximity to Westmead Train Station. Parking is unrestricted unlike much of the other surrounding streets. As a consequence, it is almost fully utilised at midday and 80-90% occupied at 9am and 3pm.
- **Parking areas within walking distance of the Oakes Centre, particularly Hawkesbury Road:** many of the parking areas around the Oakes Centre are fully occupied (e.g. at 12pm) or 80-90% occupied. This is attributed to the lack of off-street parking for residents at the centre and for employees at the businesses. This parking is a mix of 1P and unrestricted parking.
- **Parking areas near Westmead Station, notably Hassall Street and Bailey Street:** it was observed that the Sydney Metro station box construction was occurring during the time of the survey, which may contribute to parking demands in the vicinity of the station.

The Oakes Centre parking demand was estimated given high levels of car parking usage (**Table 3-4**).

Table 3-4 Parking demand for Oakes Centre

Time	Total spaces	Parking demand	Free spaces	Average occupancy
9am	73	62	11	85%
12pm	73	67	6	92%

This survey is necessarily limited – it is focussed on a typical weekday and doesn't cover weekend demands. The centre appears to have a peak parking demand of around 67 parking spaces.

3.5 Walking

Walking accounts for 4.8 per cent of current journey to work trips (2016 data) and 35.4 per cent of all daily journeys⁶.

The footpath coverage in Westmead South is shown in **Figure 3-8**. It shows that almost all streets have footpaths on at least one side, and all of the key road corridors have footpaths on both sides (such as Hawkesbury Road, Bridge Road and Great Western Highway). The future Mays Hill Precinct Master Plan will complete missing links in Parramatta Park, providing connectivity to Parramatta CBD.

Because of the street network, Amos Street provides an important east-west connection from Westmead South to Parramatta CBD, as it has the most convenient east-west alignment for walking, as it does not need pedestrians to cross the rail line, connects many of the north-south streets, and is also a lower-order street (therefore having lower traffic volumes).

Canopy coverage has a statistically significant impact on rates of walking⁷, so is included in the analysis of the walking network (**Figure 3-9**). Data was sourced from NSW Department of Planning and Environment (2019). The mapping shows:

- The highest rates of tree coverage are generally in the north-east and south-west of Westmead South.
- Street corridors generally have less concentration of street trees compared to residential lots.
- Hawkesbury Road, which is future primary north-south walking link, has relatively low tree canopy coverage.
- Amos Street, which is an important east-west connector, has relatively low tree canopy coverage.

Walking catchment maps were completed for travel to the rail (and future Metro) station (**Figure 3-11**). The northern portion of the study area has excellent access to public transport and also aligns with where future development is mainly proposed. Typically, a walking distance of 800m (10 minutes) is considered an appropriate travel distance to travel to a train station, though some customers are willing to travel further⁸. For residents further south in the Westmead South precinct, bus routes on Great Western Highway would be a more attractive public transport option, providing connectivity and interchange with Parramatta train station.

The entirety of Westmead South is within a 26-minute walk of Parramatta CBD (2.1km) and 19-minute walk of Westmead Health and Innovation District (1.5km). As a 'walk only' trip, this is generally an appropriate (even a short) travel distance.

Pedestrian-related crash data is shown in **Figure 3-10**. The data shown is a summary of the severity of crashes from 2017 to 2021. There was a total of five pedestrian crashes in the area. Four of the five crashes were serious injury severity. Pedestrian crashes tend to be typically more severe as pedestrians are more vulnerable than other road users (such as drivers in cars), and more likely to be injured.

Some of the key barriers to walking in Westmead South are:

- Lack of pedestrian-priority crossings
- Gaps in footpath coverage
- Lack of tree canopy (particularly during summer months)
- High traffic volumes on streets (particularly Hawkesbury Road)

One of the key limitations of the study area is the types and frequency of pedestrian crossing opportunities along Hawkesbury Road. As the current main distributor-function road in the network, it carries a substantial amount of traffic (1,100 veh/h in the morning peak and 1,000 veh/h in the evening peak). With vehicle volumes of this size, pedestrian crossings with pedestrian priority are typically necessary to improve rates of walking.

The current spacing of east-west crossings along Hawkesbury Road is:

- 182m between Alexandra Avenue signalised crossing and Priddle Street signalised crossing
- 306m between Priddle Street signalised crossing and the midblock signals north of Ralph Street
- 263m between the midblock signals north of Ralph Street and Amos Street signalised crossing

⁶ Walk only + walking linked trips

⁷ Borst, Hieronymus C., et al. "Relationships between street characteristics and perceived attractiveness for walking reported by elderly people." *Journal of environmental psychology* 28.4 (2008): 353-361.

Ladina, Mohd Azizul, et al. "Developing a Model for Planting Trees Along the Walkway." *Jurnal Teknologi* 69.2 (2014).

⁸ SOURCE

- 219m between Amos Street signalised crossing and a midblock island refuge
- 112m between a midblock island refuge and Great Western Highway signalised crossing.

TfNSW's Pedestrian Crossing Guideline (TS 00043:1.0) suggests a crossing frequency/spacing of:

- For a "main street", 40-100m spacing
- For a "local street", 100-200m spacing
- For a "civic space", 40-60m spacing.

Even if Hawkesbury Road were considered a local street, the crossing frequency does not meet the typical guidelines.

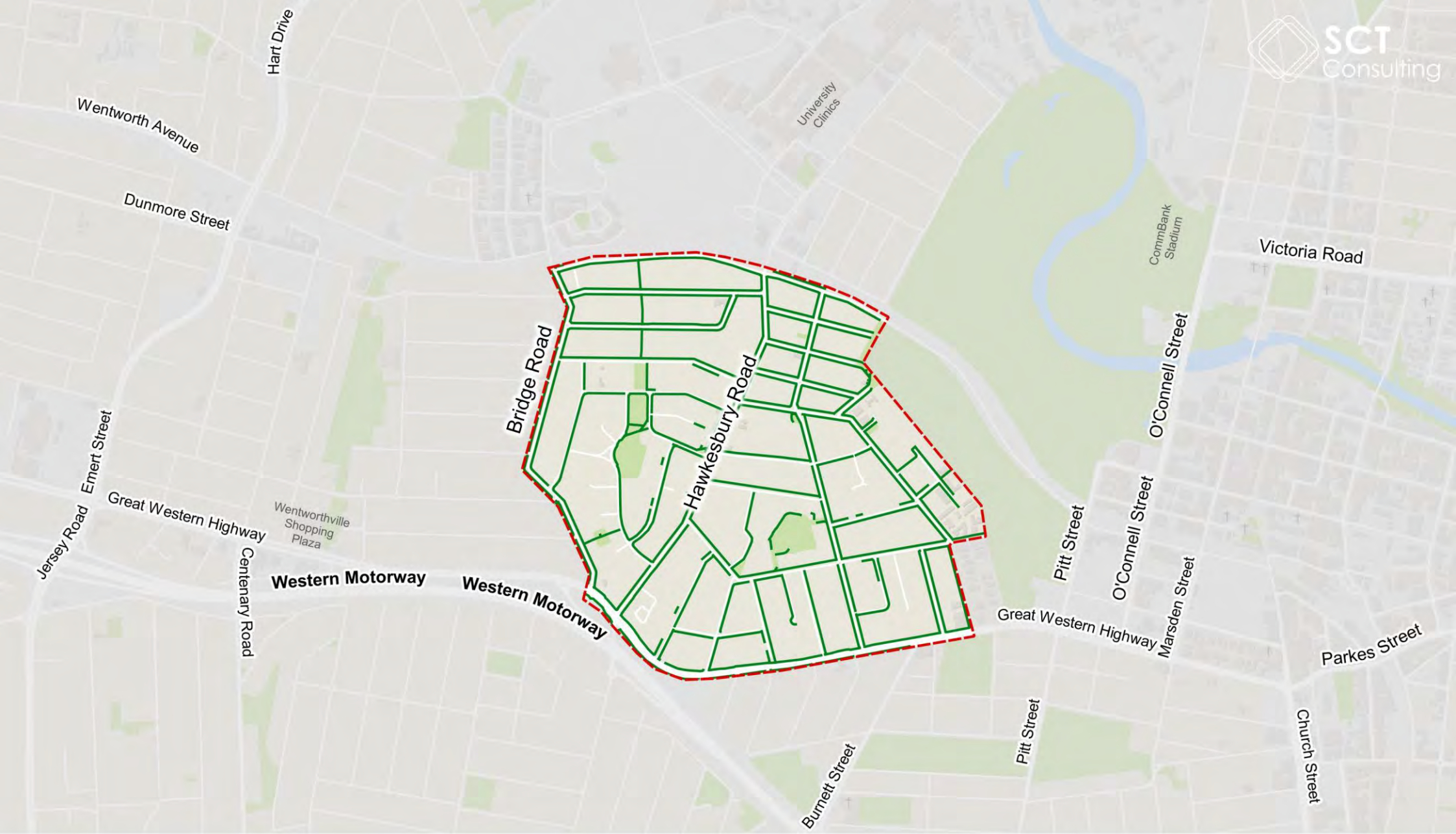

- Legend**
- - - Study area
 - Existing footpath

Figure 3-8 Footpath coverage

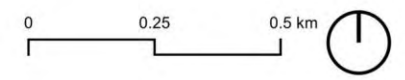

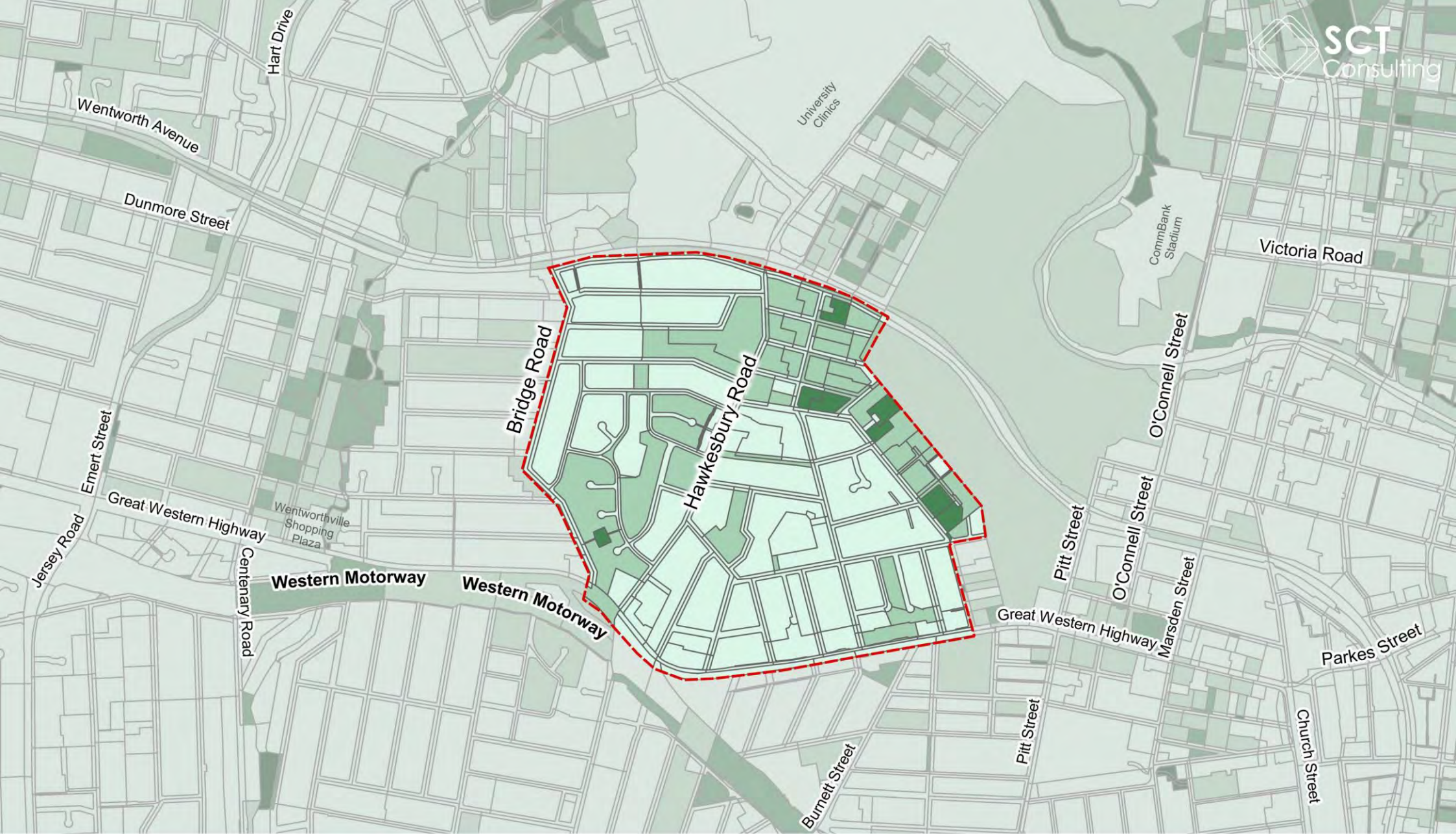

Legend
 - - - Study area

Percentage Tree Cover

	0% - 20%
	20% - 40%
	40% - 60%
	>60%

Figure 3-9 Tree canopy coverage

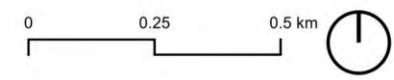



Legend
 - - - Study area

Crash severity (pedestrian only)

- Fatality
- Serious injury
- Moderate injury
- Minor/other injury
- Non-casualty (towaway)

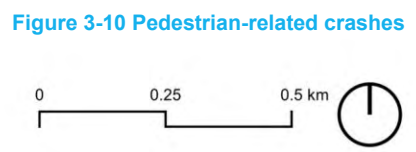

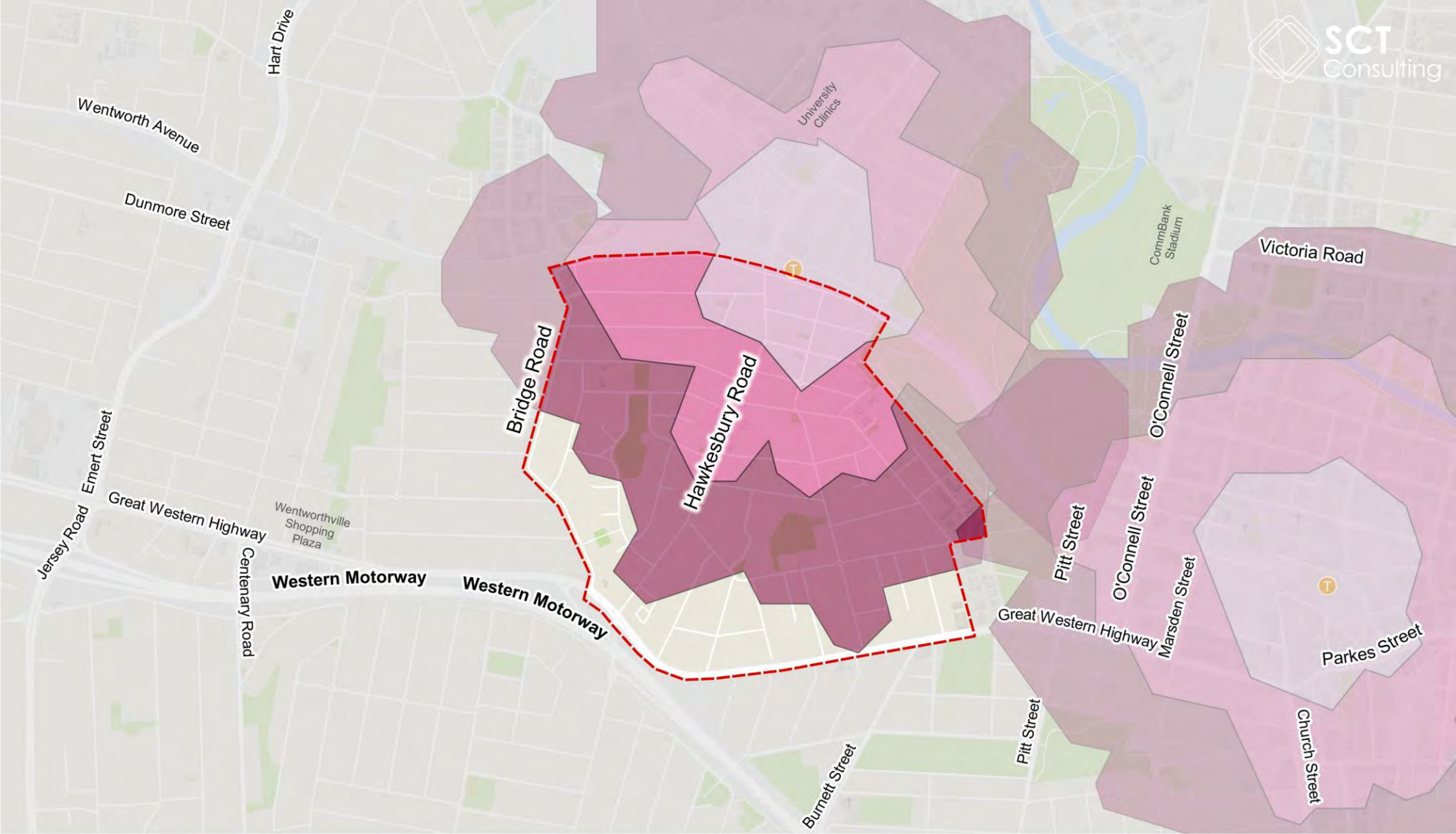

Legend

Study area

Walking catchment

- Start point
- 5min
- 10min
- 15min

Figure 3-11 Walking catchments to rail



3.6 Cycling

Walking accounts for 0.1 per cent of current journey to work trips (2016 data) and up to 2.6 per cent of all daily journeys.

The current cycling infrastructure in the network is shown in **Figure 3-12**.

Westmead South sits between two Green Grid connections, the M4 shared path links, which join Wentworthville to Sydney Olympic Park and Wentworth Point via Auburn, Granville and Parramatta and the Parramatta Valley Cycleway. These two regional routes provide east-west connectivity from Westmead through to:

- Parramatta CBD
- The Parramatta Road Corridor
- Sydney Olympic Park
- Strathfield
- Wentworthville
- Old Windsor Road corridor, including Toongabbie, Bella Vista, Kellyville, Rouse Hill and beyond.

Parramatta's bike plan evaluated propensity to cycle and found that Westmead, particularly the northern parts and eastern parts of the suburb had a propensity of between 0.81 – 0.97, the highest quintile of results reported. The site therefore has great potential to be a cycling precinct.

The discrepancy between the actual rates of cycling is likely:

- The data being dated (2016)
- Lack of cycling infrastructure within the precinct
- Lack of 'feeder' routes that connect Westmead residents to these regional routes.

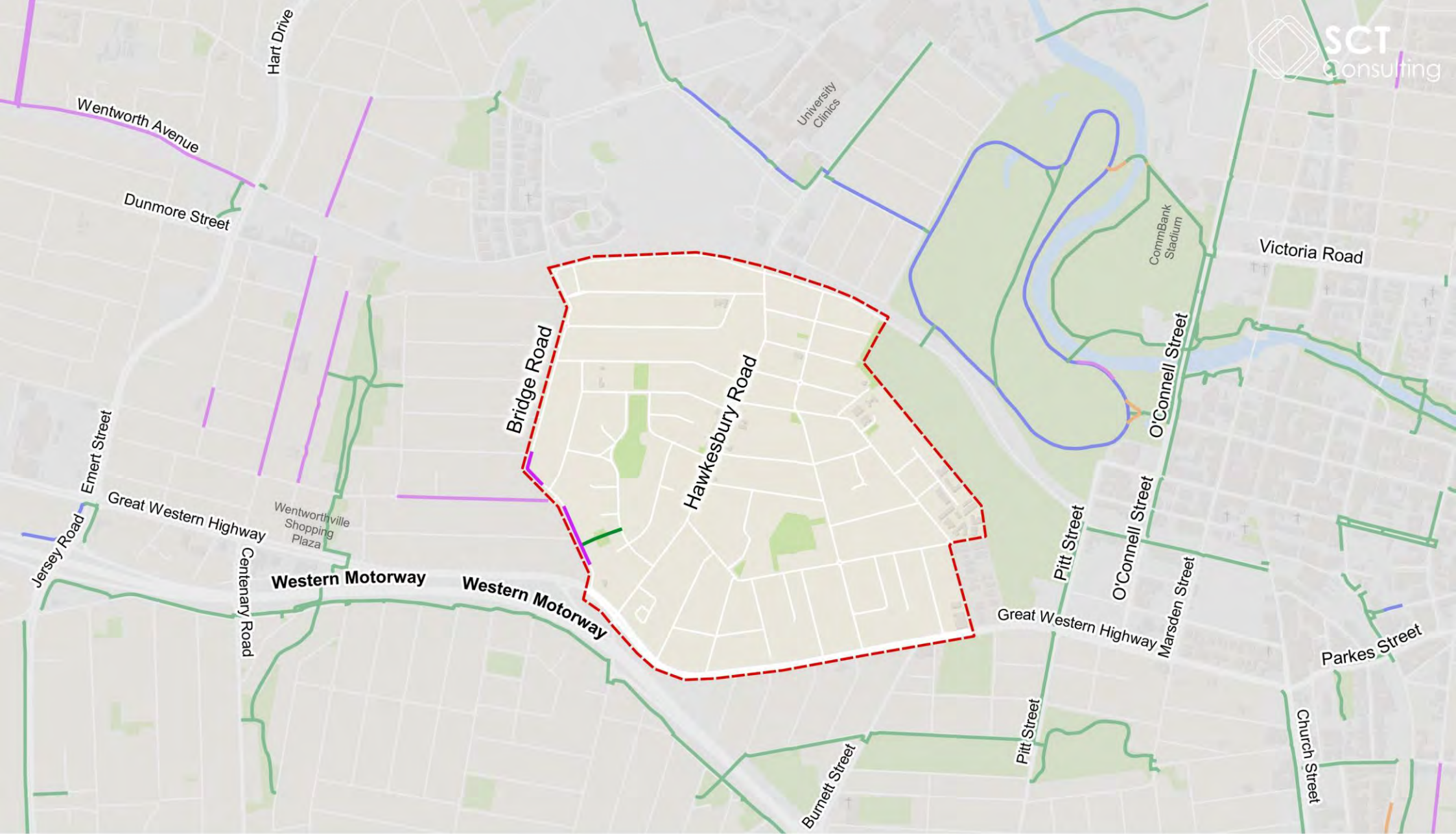

Legend

- - - Study area
- Shared use/zone
- Bicycle lane
- Road shoulder (Parking lane / Emergency stopping lane / High speed shoulder)
- Quietway

Figure 3-12 Cycling infrastructure

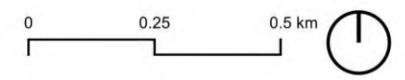

3.7 Bus

The current bus routes in the area are shown in **Figure 3-13** and summarised in **Table 3-5**.

Table 3-5 Bus frequency of routes in Westmead South

Route	From	To	Frequency	
			AM	PM
660 Castlewood to Parramatta via Norwest	Castlewood	Parramatta	3	5
	Parramatta	Castlewood	3	3
661 Parramatta to Blacktown via North West Tway & Kings Langley	Parramatta	Blacktown	3	4
	Blacktown	Parramatta	2	2
662 Castle Hill to Parramatta via Bella Vista & North West Tway	Parramatta	Castle Hill	3	5
	Castle Hill	Parramatta	3	3
663 Parramatta to Rouse Hill Station via Glenwood	Parramatta	Rouse Hill Station	3	6
	Rouse Hill Station	Parramatta	7	4
664 Rouse Hill Station to Parramatta via Norwest	Rouse Hill Station	Parramatta	6	3
	Parramatta	Rouse Hill Station	3	7
665 Parramatta to Rouse Hill Station	Parramatta	Rouse Hill Station	4	8
	Rouse Hill Station	Parramatta	10	4
700 Parramatta to Blacktown	Parramatta	Blacktown	4	4
	Blacktown	Parramatta	4	4
705 Blacktown to Parramatta via Pendle Hill	Parramatta	Blacktown	1	2
	Blacktown	Parramatta	3	2
708 Constitution Hill Retirement Community to Parramatta via Pendle Hill	Parramatta	Constitution Hill	0	1
	Constitution Hill	Parramatta	1	0
711 Blacktown to Parramatta via Constitution Hill	Blacktown	Parramatta	2	4
	Parramatta	Blacktown	2	3
712 Westmead Childrens Hospital to Parramatta	Westmead Childrens Hospital	Parramatta	2	1
	Parramatta	Westmead Childrens Hospital	1	2
818 Westmead Hospitals to Merrylands	Merrylands	Westmead Hospital	1	1
	Westmead Hospital	Merrylands	1	1
824 Parramatta to Westmead Hospitals via South Wentworthville	Parramatta	Westmead	2	2
	Westmead	Parramatta	2	2
N70 Penrith to City Town Hall via Parramatta (Night Service)	Penrith	City Town Hall	0	0
	City Town Hall	Penrith	0	0
N71 Richmond to City Town Hall via Parramatta (Night Service)	Richmond	City Town Hall	0	0
	City Town Hall	Richmond	0	0

Source: TfNSW, 2023

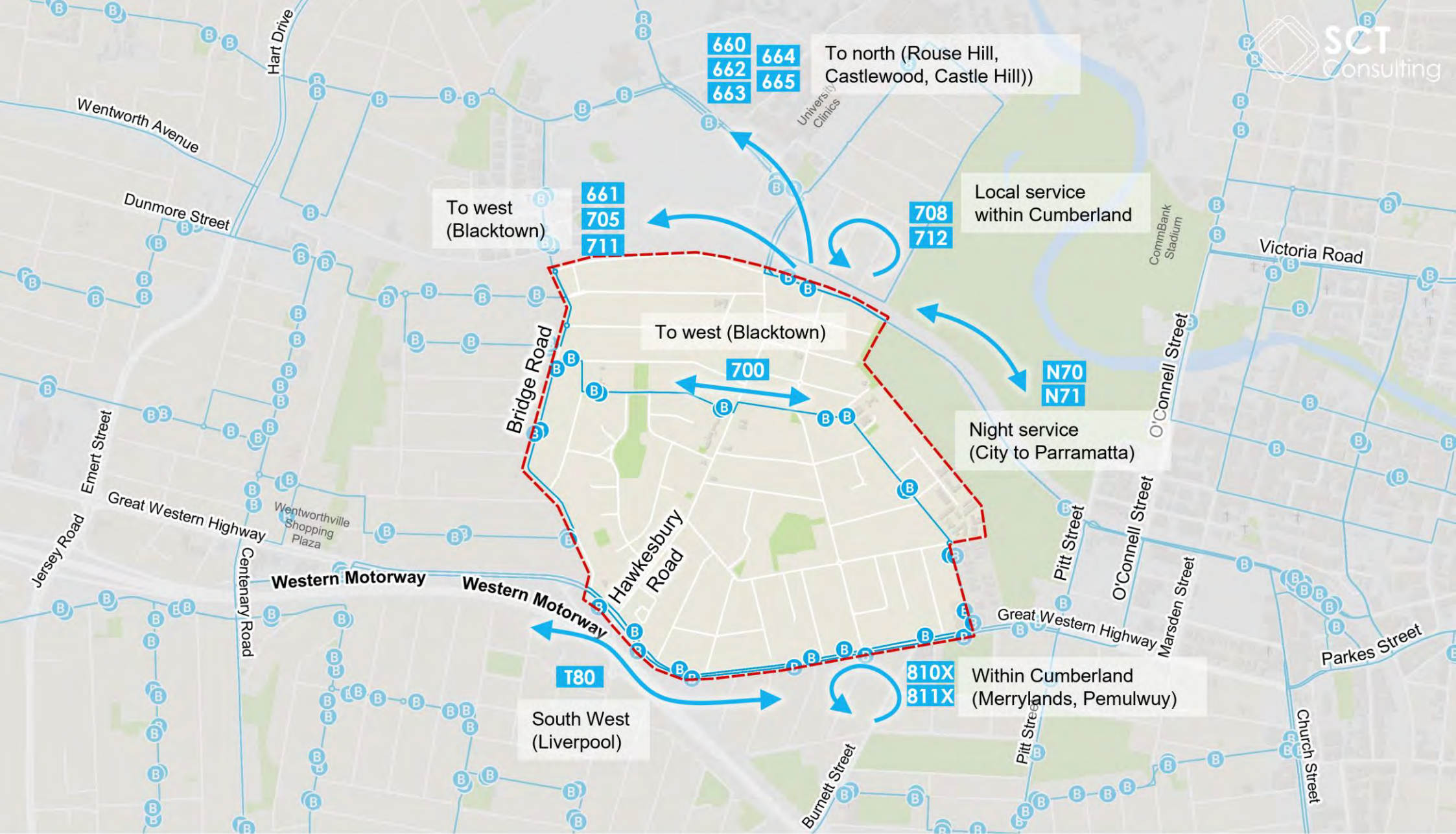

- Legend**
- - - Study area
 - B Bus stop
 - Bus routes

Figure 3-13 Bus routes

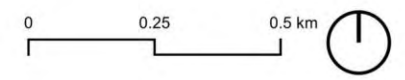

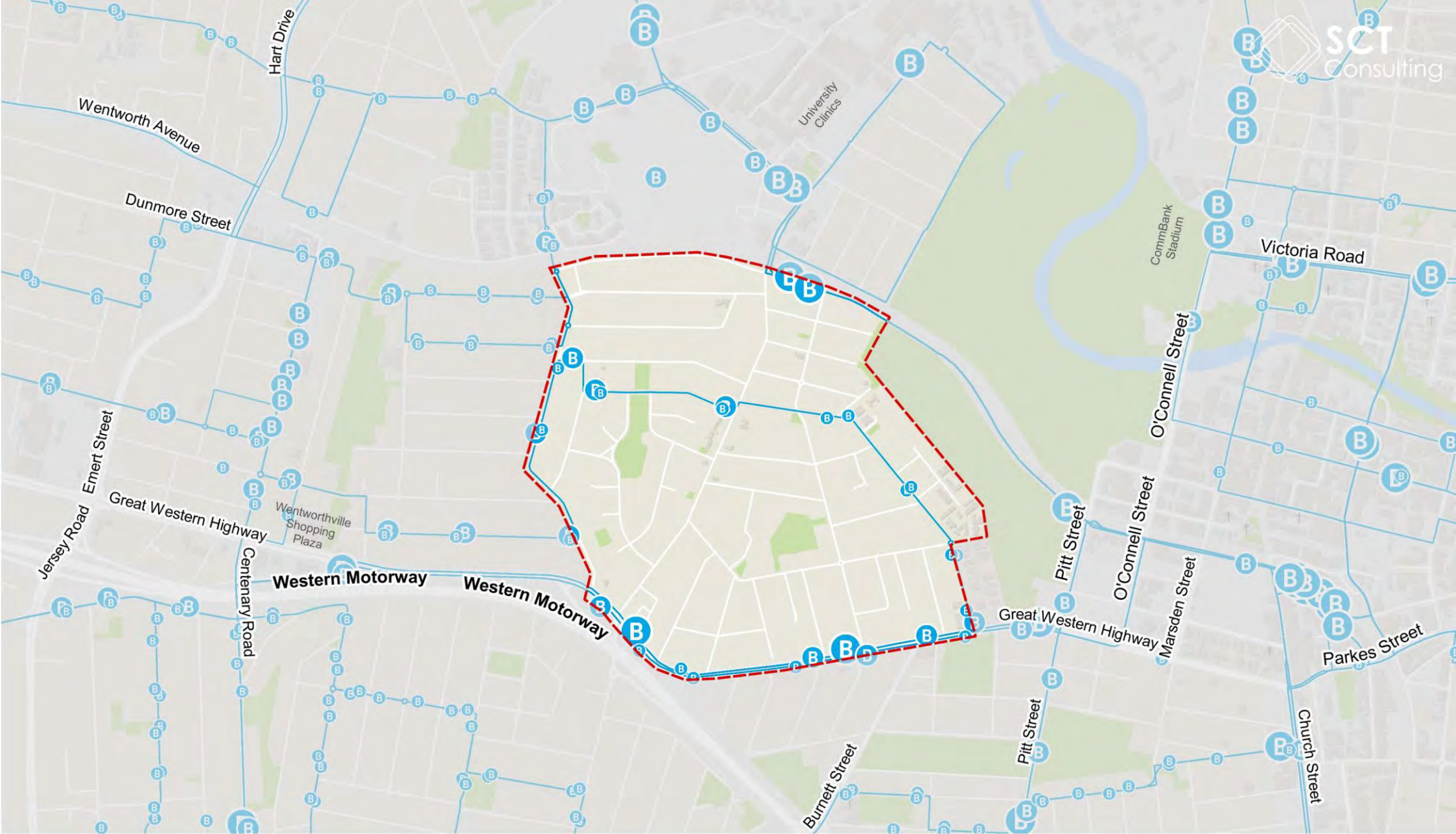

- Legend**
- - - Study area
 - Bus routes

- Bus frequency per hour**
- B 1-5
 - B 5-10
 - B >10

Figure 3-14 Bus stop frequency



Routes 705, 708, 818 and 824 touch the study area to the west, turning from Vernon Street to Bridge Road, leave the study area, then return and interchange with Westmead Station.

Many of the other routes (such as 660 – 665) only enter the network at Westmead Station, providing a T-way style connection through to Parramatta from the North West.

The combined frequency of the services is significant – about 76 services in the morning and 83 services in the evening peak hours.

3.8 Rail

Westmead Station current caters for services on the following lines:

- Blue Mountains Line
- T1 Western Line
- T5 Cumberland Line.

The frequency of each of these rail lines is provided in **Table 3-6**.

Table 3-6 Frequency of rail lines

Route	From	To	Frequency	
			AM	PM
Blue Mountains Line Bathurst and Lithgow to Central	Bathurst/ Lithgow	Central	1	0
	Central	Bathurst/Lithgow	1	1
T1 Emu Plains or Richmond to City	Emu Plains/Richmond	City	8	11
	City	Emu Plains/Richmond	9	10
T5 Cumberland Line	Leppington	Richmond	2	2
	Richmond	Leppington	2	2

Source: TfNSW, 2023

4.0 Draft Westmead South Master Plan

4.1 Structure plan

Council's draft vision for Westmead South is:

Westmead South will have evolved into a unique place, providing living and employment close to public transport.

It will be a smart precinct built upon its rich Indigenous and historical heritage, leveraging health and innovation uses in broader Westmead area.

Its character will be further defined by high quality public spaces, diverse building typologies and uses. A network of green spaces coupled with walking and cycling initiatives will ensure Westmead South evolves into a liveable inner city precinct distinct itself from the surrounding suburbs.

The urban design vision for the draft Westmead South Master Plan is that:

Westmead South will be one of the best connected places in Sydney. New open spaces, upgraded streets, improved cycle and pedestrian connectivity is fundamental to delivering a sustainable outcome for Westmead South.

This vision captures the importance of transformative transport connectivity to the realisation of success at Westmead South.

Key focal points of the urban design vision are that the precinct will be connected + collaborative, diverse + innovative, green + resilient and local + liveable.



The structure plan for the precinct is shown in **Figure 4-1**.

This structure plan has several transformative elements for the transport system:

- Hawkesbury Road will function as a High Street, providing north-south cycling connectivity in fulfilment of Council's Draft Walking and Cycling Strategy Route 4, which connects Westmead to Merrylands via the M4 Cycleway.
- Strengthened cycling infrastructure running east-west along Alexandra Avenue.
- Creation of a north-south green link from M J Bennett Reserved through to Alexandra Avenue
- Strengthening of Amos Street as a connection through to Parramatta CBD.

Draft Westmead South Structure Plan

Excerpt of Architectus draft Urban Design Report

Area	FSR (of which retail)	Storeys	Land use / description
A0	5.9:1 (0.7:1)	25	Mixed use - Adjacent Station Development site (+ affordable housing)
A1	0.5:1 (Metro station)	1-2	Metro site - station entrance and supporting services
A2	4.5:1 (0.6:1)	20	Mixed use (+ community facility and affordable housing)
A3	4.2:1 (0.6:1)	20	Mixed use (+ affordable housing)
A4	2.8:1 (0.6:1)	15	Mixed use
B1	3.6:1	25	High density residential (+ new open space and through site link)
B2	3.6:1	15	Residential apartments (+ affordable housing and through-site link)
B3	3.6:1	20	Residential apartments (+ commuter car park)
B4	3.2:1	15	Residential apartments (+ affordable housing)
C	2.9:1	12	Residential apartments
D1	2.5:1	8	Residential apartments (+ through site link)
D2	2.5:1	8	Residential apartments
D3	2.5:1	8	Residential apartments
E0	1.2:1	4	Residential apartments
E1	1.6:1	6	Residential apartments
E2	1.6:1	6	Residential apartments
E3	1.6:1	6	Residential apartments
E4	1.6:1	6	Residential apartments
E5	1.6:1	6	Residential apartments
E6	1.6:1	6	Residential apartments
E7	1.6:1	6	Residential apartments
E8	1.6:1	6	Residential apartments
F0	3.2:1 (0.6:1)	8	Mixed use (Hawkesbury Road high street)
F1	3.2:1 (0.6:1)	8	Mixed use (Hawkesbury Road high street)
F2	3.2:1 (0.6:1)	8	Mixed use (Hawkesbury Road high street)
G0	2.5:1 (0.6:1)	8	Mixed use (Great Western Highway E3 zone)
G1-1	2.2:1 (0.6:1)	8	Mixed use (Great Western Highway E3 zone)
G1-2	2.2:1 (0.6:1)	8	Mixed use (Great Western Highway E3 zone)
G1-3	2.2:1 (0.6:1)	8	Mixed use (Great Western Highway E3 zone)
G1-4	2.2:1 (0.6:1)	8	Mixed use (Great western highway extension)
G2-1	1.8:1 (0.6:1)	6	Mixed use (Great western highway extension)
G2-2	1.8:1 (0.6:1)	6	Mixed use (Great western highway extension)
G3	3:1 (0.4:1)	12	Hawkesbury Place site (+ open space and community facility)
H	12:1 [no change]	4	Residential apartments (existing blocks)
I	0.7:1	2	Medium density residential (1-2 storeys)
J0	0.7:1	2	Low to medium density residential (1-2 storeys)
J1	0.7:1	2	Low to medium density residential (1-2 storeys)
J2	0.7:1	2	Low to medium density residential (1-2 storeys)
J3	0.7:1	2	Low to medium density residential (1-2 storeys)
K	-	1	Potential Special Character Area or Heritage Conservation Area

Area	FSR (of which retail)	Storeys	Land use / description
G2-2	1.8:1 (0.6:1)	6	Mixed use (Great western highway extension)
G3	3:1 (0.4:1)	12	Hawkesbury Place site (+ open space and community facility)
H	12:1 [no change]	4	Residential apartments (existing blocks)
I	0.7:1	2	Medium density residential (1-2 storeys)
J0	0.7:1	2	Low to medium density residential (1-2 storeys)
J1	0.7:1	2	Low to medium density residential (1-2 storeys)
J2	0.7:1	2	Low to medium density residential (1-2 storeys)
J3	0.7:1	2	Low to medium density residential (1-2 storeys)
K	-	1	Potential Special Character Area or Heritage Conservation Area

Legend - other items

- Westmead South boundary
- SP1 zone - school
- Potential Heritage Conservation Area
- Potential Special Character Area or Heritage Conservation Area
- Potential heritage item
- Existing Heritage Conservation Area
- Unlikely to change (existing heritage item)
- Unlikely to change (school, church, strata title)
- Hawkesbury Road - movement spine
- Key pedestrian streets

- Existing open spaces
- New public plaza - Oakes Centre and Metro plaza
- Potential new open space (dedication or other)
- Existing pocket parks to be zoned RE1
- Hawkesbury Road high street - active frontages
- Great Western Highway frontage - ground floor non-residential uses
- Laneway (dedication or other)
- Proposed laneway (dedication or other)
- Widened link - Dedication through development - 4.5m of 6m setback



Figure 4-1 Westmead South Structure Plan

The draft Westmead South Master Plan Urban Design Report provides explanation of each of the elements of the structure plan. This plan should be read in conjunction with the Urban Design Report.

4.2 Road hierarchy

Each of the streets and roads in the area have been designed with a movement and place lens. TfNSW's Design of Roads and Streets (TfNSW, 31 March 2023) identifies four street environments against the movement and place backdrop (**Figure 4-2**).

The design guide then identifies a suite of different street and road typologies within each of the categories. Each of the streets in the network have been designed using an indicative typology from the design guide. This work is summarised in **Table 4-1**.

Figure 4-2 Movement and Place four street environments



Table 4-1 Movement and Place and street typologies of proposed network

Street	Movement factors	Place factors	Street type
Great Western Highway	State Road, carrying significant traffic volumes as well as an important T-Way connection.	No mixed use or active frontages	Principal Arterial Road
Hawkesbury Road	Moderate movement function for vehicles – reduced from current. High significance cycling movement corridor	Increased active frontages but ground floor activation set back from Hawkesbury Road (6m). Destinations scattered along alignment	Arterial High Street, transitioning to Destination High Street
Alexandra Avenue, Grand Avenue, Hassall Street south and Bridge Road	Moderate movement function, providing access for multiple lower order streets	No mixed use or active frontages for majority of alignment.	Connector Street
Hassall Street north	Low movement function – vehicle access, waste collection, freight and service delivery	Active frontages and tighter setbacks (3m)	Destination High Street
M J Bennett Reserve North-South Link	Pedestrian movement only	Play opportunities and public open space	Street Park
Other streets	Low movement function – vehicle access, waste collection, freight and service delivery	No mixed use or active frontages	Neighbourhood Street

Great Western Highway will remain as a Principal Arterial Road into the future. It has an important traffic and bus-carrying function and there is limited change expected around this corridor.

Hawkesbury Road will experience a transition as place intensity grows along the corridor. It currently functions with a degree of through vehicle movement, but this will decline as interventions prioritise pedestrian east-west connectivity and improved cycling infrastructure. With a new Sydney Metro West station at the northern end, the northern end of Hawkesbury Road will slowly transition to a high place-low speed environment.

Bridge Road will need to take an increased load of traffic that transitions away from Hawkesbury Road. However, the precinct will transition from carrying some through traffic to carrying very little. The highly urban nature of the area and high quality streetscapes will be deliberately slow environments that prioritise walking and cycling.

This concept is covered in **Figure 4-3**.



Legend

- Study boundary
- Intersection upgrades

Road hierarchy

- Connector Street
- Destination High Street
- Neighbourhood Street
- Principal Arterial Road

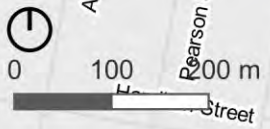

© SCT C **Figure 4-3 Road functionality and upgrades**

4.3 Multi-modal functionality

The movement network in the master plan is summarised by the following principles:

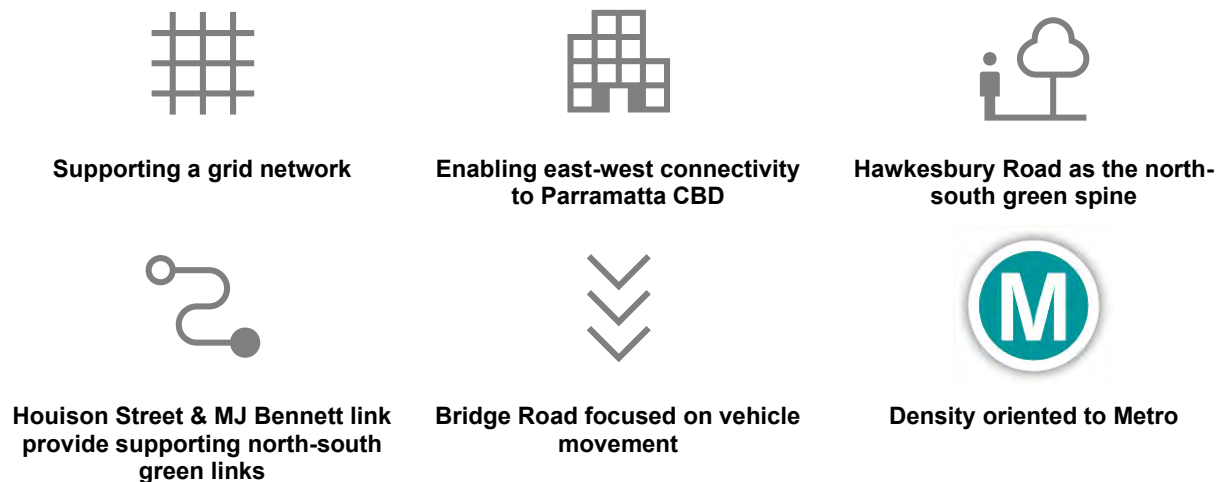

The delivery of a new Metro Station in Westmead will start the transition of the precinct. Sydney Metro West will enable a journey from Westmead to Sydney CBD of less than 23 minutes (subject to number and location of stations) – a ten minute saving on the current travel times.

Westmead's role will grow from being an intermediate station on a service to an important interchange between various high-order modes:

- Sydney Metro West
- Parramatta Light Rail
- T-Way bus services.

Hawkesbury Road will have to cater for the large increase in pedestrian volumes, with a total forecast of 4,100 pedestrians per hour in the morning peak. By comparison, the number of vehicles currently is 2,000. **That means that there could be twice the number of pedestrians as cars at this intersection.**

As densification increases, pedestrian demands to and from public transport will continue to grow. As a result, Hawkesbury Road needs to transition to focus on the largest transport customer group – pedestrians. To better cater for pedestrians, Hawkesbury Road should:

- Have reduced speed limits from Alexandra Avenue at least as far as the Oakes Centre (40km/h)
- Provide for an increased number of pedestrian crossing opportunities
- Provide the primary north-south cycling connection. The slow vehicle speeds also benefit the safety of cyclists
- Transition over time to a people not movement focussed street.

Bridge Road will need to take an increase load of traffic. Intersection upgrades are proposed along Bridge Road to help support the increase in traffic load while still catering for pedestrian crossing opportunities.

4.4 Cross-sections

Cross-sections are provided in the draft Westmead South Master Plan Urban Design Report (Architectus, 2023) and were defined collaboratively across the project team, capturing the transport network requirements.

4.5 Transport upgrades

Intersection upgrades are proposed to support the growth coming to the area (**Table 4-2**).

Table 4-2 Action plan – intersection upgrades

Action		Details
R.	Road upgrades	
R.1	Reconfigure Hawkesbury Road corridor including all intersections from Alexandra Avenue through to Pye Street	– Intersections require reconfiguration to match the proposed cross-section of Hawkesbury Road, which proposes an on-road cycleway via road space reallocation when required.
R.2	Bridge Road / Grand Avenue capacity increases	– Right turn ban for Veron Street. – Bridge Road between Alexandra Avenue and Austral Avenue needs a four-lane cross section.
R.3	Bridge Road / Moree Avenue left in left out treatment	– Removal of a roundabout necessary to enable capacity increase on Bridge Road.
R.4	Bridge Road / Austral Avenue signalisation	– Due to increase in traffic demands and importance of Bridge Road carrying traffic, signalisation is proposed.
R.5	Bridge Road widening over the rail corridor	– Investigate providing a railway corridor duplication to improve travel times on Bridge Road.
R.6	Capacity increases at Great Western Highway / Bridge Road	– Widening is required at both intersections to achieve satisfactory performance of Great Western Highway.
R.7	Capacity increases at Great Western Highway / Hawkesbury Road / Coleman Street	

The performance of these upgrades is evaluated in **Section 7.0**.

5.0 Parking strategy

Parking in the street
 Parking is only one of the functions of a street, so planning must be holistic across all the different street functions.



5.1 Principles

The public road network is an important and popular public asset. Streets provide many functions: meeting places, access to properties, vehicle through traffic, parking, play spaces for children, routes for pedestrians and cyclists, bus corridors, natural environment, as well as many operational functions (services, stormwater, lighting).

Parking does have a role in the local street. Biswas et. al. summarise the benefits of on-street parking as follows: “On-street parking provides safety to road users through two leading means: (a) as a traffic calming tool—lowering the speed and enhancing the safety, and (b) as a buffer—separating pedestrian activities from the vehicular flow.”⁹

Marshall et. al provide further evidence on this in a study of American roads: “Low-speed streets with on-street parking also had the lowest fatal and severe crash rates of any road category in the study of 250 Connecticut roadway segments. Part of the reason is that the presence of parking had a measurable effect on vehicle speeds. On-street parking is not purely a device to be used in the right environment; rather, it is a tool to help create that right environment. On-street parking should be more commonly used but especially in situations in which the road is part of the destination and the intent is to cause drivers to slow down. Results suggest that these places are safer, are more walkable, require less parking, and have more vitality.” (emphasis added)¹⁰

The principles in setting parking policy are:



Target car parking occupancy of 80-90%



Manage commuter car parking requirements



Support car share, bus zones, freight & servicing

When parking spaces are too busy, drivers need to drive further to find a parking spot. **When parking areas are 85% full, a driver should be able find a parking space on each street.** When policy like this was implemented in San Francisco reduced driving distance by 30%, reducing congestion and pollution.

Westmead Station is supported by a wide network of bus services, which should be the preferred mode of station access. Modelling shows that the network will operate with congestion into the future, requiring upgrades. **Commuter car parking would increase the need for intersection widening** schemes and increase the cost of contributions—so it’s important to avoid expanding.

As density increases, **on-street parking needs to be formalised to support different users** – car share, bus zones, freight and servicing. While many functions can occur off-street, on-street use for these functions can be more efficient.

5.2 Expected areas of parking impact

The existing approach to parking is the use of 2P time restrictions for the areas within Westmead South that are nearby trip attractors such as apartments, shops and the rail line.

As the area continues to grow, demand for on-street parking will extend further through the study area, not just into the areas with land use change, but also those within a walking distance of the denser land uses. The demand for overspill parking is a complex task and interdependent with on-street parking controls. A forecasting exercise was conducted based on a 400m walk from all the new development precincts. A 400m catchment is a five minute walk and is the maximum likely walk for drivers trying to avoid time restrictions.

Figure 5-1 overleaf shows the extent of coverage of the study area based on a 400m walking distance to areas with land use change.

⁹ Biswas, S., Chandra, S., & Ghosh, I. (2017). Effects of on-street parking in urban context: A critical review. *Transportation in developing economies*, 3(1), 10.
¹⁰ Marshall, W. E., Garrick, N. W., & Hansen, G. (2008). Reassessing on-street parking. *Transportation Research Record*, 2046(1), 45-52.

The catchment analysis shows that almost all of Westmead South is covered by the potential parking impacts of the new development. The parking action plan in the next section identifies mitigations to soften the impacts of overspill parking demand on other residents.

5.3 Parking action plan

Parking action plan items are described in **Table 5-1**.

Table 5-1 Parking action plan

Action		Details
P	Parking	
P.1	Extend coverage of 2P parking	<ul style="list-style-type: none"> Extend the coverage of the 2P (permit holders excepted) parking area to cover the 400m walking catchment to density (Figure 5-1)
P.2	Manage occupancy actively	<ul style="list-style-type: none"> Conduct regular reviews of the parking time restrictions using a clear decision tree so that parking occupancy sits around 80-90%
P.3	Manage permit scheme closely	<ul style="list-style-type: none"> The parking permit scheme rules should exclude residents who live in apartments due to the potential for permits exceeding the number of parking spaces in the network Keep a database of the number of permits issued and review policy if the number of permits in a street exceeds the amount of on-street parking capacity
P.4	Manage commuter car parking requirements	<ul style="list-style-type: none"> Alexandra Avenue has indicatively 80 parking spaces used for informal commuter car parking, which arise from the unrestricted parking on the northern side. Site observations are that commuters use this parking for access to Westmead Station. With increased demand, this commuter car park function will likely erode over time, with increased demand for on-street parking. If possible, 50-100 spaces could be provided in a commuter car park facility The commuter car park should be Opal-restricted to ensure it is not being used by other drivers in the area.

SCT Consulting has a framework that we recommend for use in parking management, which creates a framework around achieving a target occupancy of 80-90%. The benefit of this framework is a reduction in congestion, pollution and difficulty parking.

In areas with little to **low demand**, there is no need for any on-street restrictions. Some streets won't reach 80-90% even if parking remains unrestricted. These low demand streets don't need any intervention and can remain unrestricted.

As places become increasingly attractive due to more trip attractors (such as train stations, playing fields, or retail), timed restrictions will be increasingly necessary. At a certain point, however, time restrictions are no longer viable. Overly onerous time restrictions beyond the '**minimum viable length of stay**' will result in a collapse of demands. For example, a playing field can't have a time restriction of 15 minutes, as this wouldn't be long enough to play a game of sport.

Figure 5-2 A management approach to retain desired levels of occupancy



Source: SCT Consulting, 2023

The minimum viable length of stay for different land uses are:

Table 5-2 Minimum viable length of stay for different land uses

Trip purpose	Minimum viable length of stay
General kiss & drop	5 minutes
Retail and business activity	1.5 hours
Community activity / event	1.5 hours
Dining	2 hours
Recreation / Open space	2 hours
Sport	2 hours
Medical / Health	3 hours
Mass transit / interchange	3 hours
Education / schools	8 hours

Source: SCT Consulting, 2023

In addition, Council resolved to investigate a commuter car park as part of the Westmead South precinct, which would address the lack of bus connections from Cumberland Council LGA into Westmead Station. The car park should be within a short distance of the station, ideally within 200m. While this is not planned for the metro station, nearby redevelopment sites may have the potential to provide commuter car parking. This needs to be considered in the context of State and local strategies for the area, demand, and impact on access and movement in the area.

6.0 Modal shift action plan

6.1 Principles

Successful modal shift is about shaping the built environment and transport systems so that sustainable modes (walking, cycling, and public transport) are genuinely attractive. Areas with high-sustainable modal share have several things in common:



Low car ownership enforced in parking controls

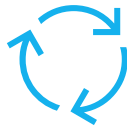

An integrated, multi-modal network



Greening of streets



Connections to public open space

Car ownership is a well-established predictor of traffic generation in decades of research globally and in Sydney. Work in 2011 by McKibbin and Bitzios Consulting based on Sydney data shows that parking availability/car ownership is one of the most important and effective predictors of car trip making.

McKibbin showed in 2011 that a 100% increase in car ownership would result in a 98% decrease in non-car mode share. This is based on Sydney data.

Car ownership is used in strategic models such as the Sydney Strategic Travel model to predict mode share.

Parking policy is one of the primary tools proposed to deliver a mode share that can be supported by the road network. Traffic modelling indicates (refer **Section 7.0**) that parking policy is a major mechanism to lower the cost of infrastructure contributions and congestion.

An integrated multi-modal network means that the travel times of sustainable modes are competitive with car. Travel demand theory says that residents tend to pick the lowest cost mode – where cost captures things like financial costs, the cost of time, the level of comfort and the reliability of the route.

Borst et Al. 2008 determined a percentage attractiveness of 16% was determined for a link with **trees present** (Borst, Miedema, de Vries, Graham, & van Dongen, 2008). This means that tree coverage isn't just important for addressing heat island effects or for property values, it also translates to an increased desirability of walking.

Work by Prof. Billie Giles-Corti from the Department of Public Health, University of Western Australia, shows that the quality of **public open spaces** increases their use. Their work found that having high quality public spaces translated to a 166% increase in the likelihood of having enough physical activity a week for residents. Much of sustainable travel isn't about commuting to work, but it's about recreational and exercise-driven purposes.

6.2 Benchmarking

Benchmarking was conducted for several comparator precincts. These precincts don't reflect the current characteristics of Westmead but show different types of centres that Westmead could become based on the master plan. The locations selected were:

- Macquarie Park
- Parramatta CBD
- Chatswood CBD
- St Leonards
- Burwood (North).

Census method of travel to work and car ownership data was obtained for the Statistical Area 2 ('SA2') geographical areas for each of the precincts. The current characteristics of Westmead are shown as 'Westmead – Mays Hill', which is the name of the SA2. **Figure 6-1** shows the car ownership and cars per household of each precinct.

Figure 6-1 Car ownership vs car mode share for residents

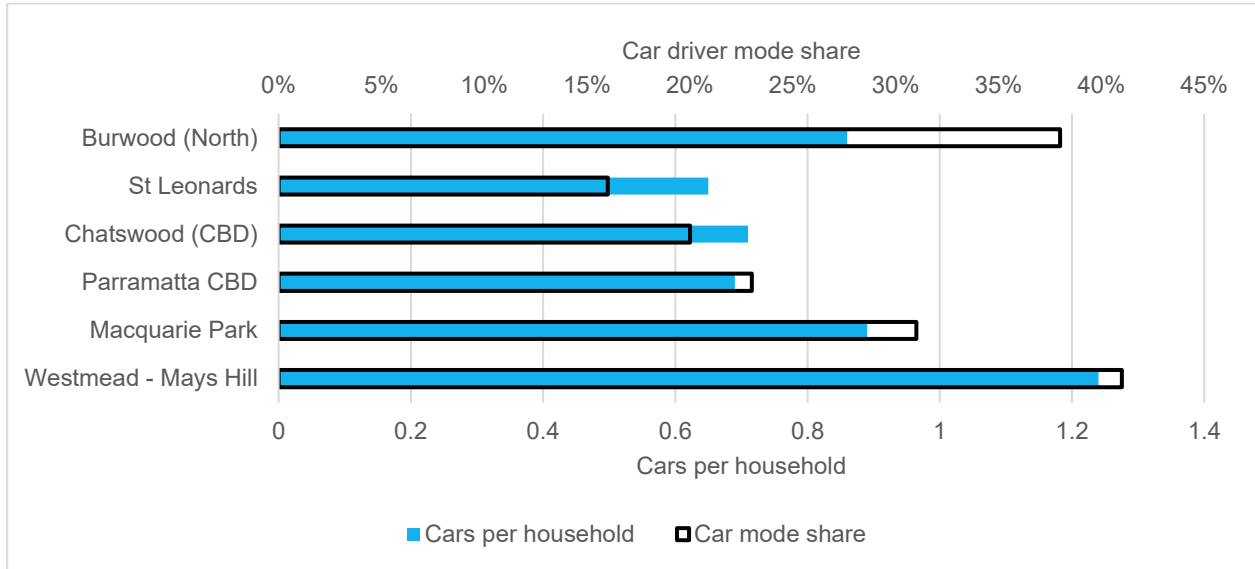

Source: idprofile, 2023

Census 2016 data was used as the 2021 census data was collected during the COVID-19 pandemic and was affected by lockdowns and work from home.

When car ownership is compared statistically against car mode share, there is a strong relationship. 76% of the variance in car mode share is explained by car ownership (**Figure 6-2**).

Figure 6-2 Relationship between car ownership and driving

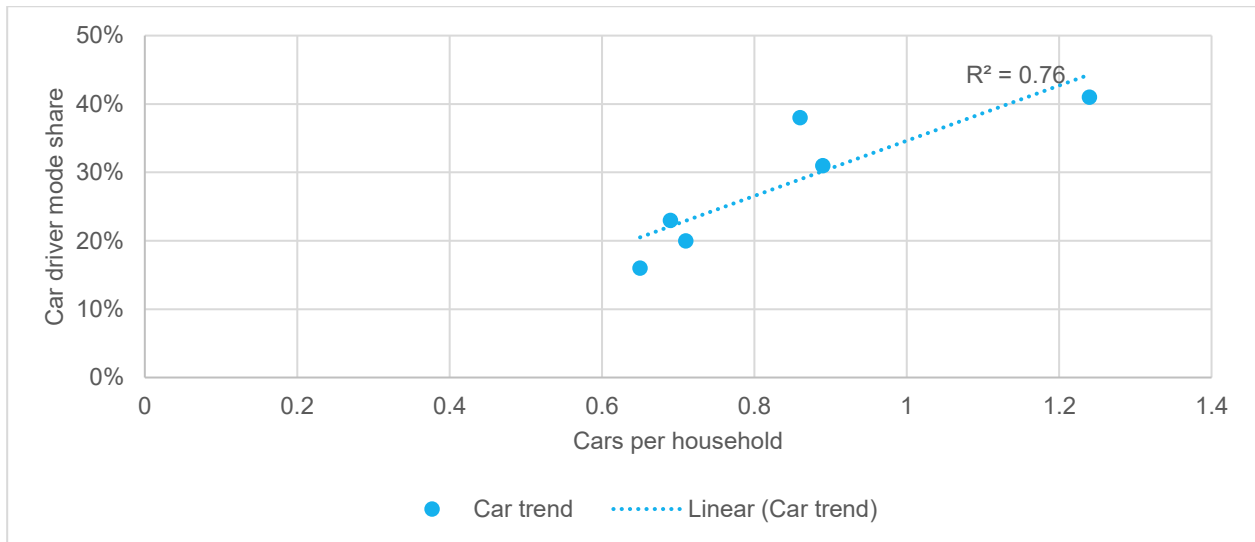

Source: SCT Consulting, 2023

It is important to note that there are many other factors that explain car driving choices, such as availability of public transport options. The above relationship simply shows that the trend identified by McKibbin in 2011 is still likely to hold today. Parking controls are a vital tool in shaping transport choices.

More detailed benchmarking is provided in Table 6-1.

Table 6-1 Detailed benchmarking of other select characteristics

Benchmark	Westmead - Mays Hill	Macquarie Park	Parramatta CBD	Chatswood	St Leonards	Burwood (North)
2016 car mode share	41%	31%	23%	20%	16%	38%
Cars / household (2016)	1.24	0.89	0.69	0.71	0.65	0.86
Average PTAL	24.5	42.3	42.7	40.5	60.5	65.9
Average PTAL category	5 - Very Good	6 - Excellent	6 - Excellent	6 - Excellent	6 - Excellent	6 - Excellent
Parking controls	Min: – 1 space / 1 or 2 bedroom unit – 1.5 spaces / 3 bedroom unit – 1 visitor space / 4 dwellings	Max: – 0.6 spaces / 1 bed – 0.9 spaces / 2 bed – 1.4 spaces / 3 bed – 1 visitor space / 10 dwellings	Max: – 0.1 spaces / studio – 0.3 spaces / 1 bed – 0.7 space / 2 bed – 1.0 space / 3 bed	Max: – 0.5 spaces / studio – 1.0 spaces / 1 bed – 1.0 spaces / 2 bed – 1.25 spaces / 3 bed – 1 visitor space / 4 dwellings	Max: – 0.3 space / studio – 0.4 spaces / 1 bed – 0.7 spaces / 2 bed – 1.0 space / 3 bed	Max: – 0.3 spaces / 1 bed – 0.5 spaces / 2 bed – 0.9 spaces / 3 bed – 1 space / 5 units
Reference	Cumberland Development Control Plan (DCP) 2021 Part G	City of Ryde DCP 2014 Part 9.3	Parramatta LEP 2023	Willoughby City Council DCP C.4	North Sydney DCP 2013 (2023 amendment)	City of Canada Bay DCP, Category C

Source: Various, 2023

The benchmarking shows that all the comparator precincts use maximum parking controls. Minimum parking controls have the purpose of preventing overspill parking within developments. Maximum parking controls have the purpose of lowering car ownership.

It is noted that the **delivery of Sydney Metro West and Parramatta Light Rail would bring Westmead into the PTAL 6 – Excellent category.**

6.3 Target mode share

Two scenarios were developed for mode share and traffic modelling:

- **Option 1:** Existing parking controls
- **Option 2:** Proposed parking controls.

The table structure below (**Table 6-2**) shows the derivation of the mode share targets.

Table 6-2 Mode share targets

	Option 1- existing controls	Option 2 – proposed controls
Traffic generation assessed in modelling	1,456 (AM) 2,174 (PM)	936 (AM) 1,397 (PM)
Number of additional dwellings	6,600 apartments	
Total person trips	3,551 (AM) 5,302 (PM)	
Car driver mode share	41%	26%
Car passenger mode share	4%	4%
Walk mode share	5%	7%
Cycle mode share	<1%	3%
Public transport	33%	45%
Work from home	10%	10%
Did not go to work	5%	5%

Source: SCT Consulting, 2023

It is assumed that 'Did not go to work (5%)' will remain comparable to existing conditions.

Work from home is a challenging forecasting component. Australian Bureau of Statistics¹¹ data indicates that 30.4 per cent of workers work from home “most of the time” and 46.2 per cent of workers work from home at some point. However, data on major road corridors indicates that many road network volumes have returned to pre-COVID-19 levels. It is therefore assumed that work from home is mostly substituted from public transport mode share (which accords with the lower patronage levels of rail networks).

This transport assessment is based on the transport demands from a total of 7,760 apartments. The draft Master Plan supports a total uplift accounting 6,621 apartments, which is 9,880 less the existing dwellings (3,259). Therefore, modelling has been conducted using this conservative approach.

¹¹ <https://www.abs.gov.au/statistics/labour/earnings-and-working-conditions/working-arrangements/latest-release#working-from-home>, <https://www.abs.gov.au/statistics/labour/earnings-and-working-conditions/working-arrangements/aug-2021#working-from-home>

6.4 Modal shift action plan

The modal shift action plan is identified in **Table 6-3**.

Table 6-3 Modal shift actions

Action	Details	Place Strategy initiative #'s
I. Infrastructure		
I.1	Deliver a walking and cycling-focused, activated Hawkesbury Road <ul style="list-style-type: none"> – Deliver the cross section proposed for Hawkesbury Road (walking, cycling, planting) – Implement a high pedestrian activity area along Hawkesbury Road (30 or 40km/h) from Alexandra Avenue at least as far as the Oakes Centre 	2.1 2.2, 2.8, 3.3, 3.9, 4.4, 4.8, 5.3
I.2	Deliver cycling connection on Amos Street <ul style="list-style-type: none"> – Deliver a separated cycleway on Amos Street 	2.8, 3.9
I.3	Deliver cycling connection on Alexandra Avenue <ul style="list-style-type: none"> – Deliver a separated cycleway long term on Alexandra Avenue, connecting through to City of Parramatta Alexandra Avenue cycleway 	2.8, 3.9, 4.4
I.4	Deliver north-south walking and cycling connection from M J Bennett Reserve <ul style="list-style-type: none"> – Deliver north-south public open space corridor including pedestrian priority crossings at each road 	2.8, 3.2, 3.9
I.5	Deliver a program of streetscape improvements <ul style="list-style-type: none"> – Improve streetscape quality on Houison Street, Hassall Street, Good Street, Bailey Street, Priddle Street, Moree Avenue, Grand Avenue and Austral Avenue – For each streetscape project, conduct a review of the speed limits and consider the appropriateness of a high pedestrian activity areas (40 or 30km/h) – For each streetscape project, consider whether additional pedestrian crossings and traffic calming measures are appropriate 	2.2, 2.7, 2.8, 3.2, 4.8, 5.3
I.6	Deliver footpath and access improvements in Westmead South <ul style="list-style-type: none"> – Improve footpaths and access on: Alexandra Ave, Austral Ave, Toohey Ave, Church Ave, Fenwick Pl, Westville Pl, Gowrie Pl, Curtin Pl, Jessop P, School Pde, Euralla St, Ralph St, Mimosa St, Thomas Clarke St, Cotswold St, Howe St, Drew St, Amos St, Parkside Ln, Bernard St, Fraser St, Whitworth St, Anderson St, Hannah St, Broxbourne St, Booth St, Telfer St, and Belgian St 	2.8, 3.2, 3.9
D. Westmead South-specific development controls		
D.1	Establish a maximum parking control for Residential - Flat Buildings and Shop Top Housing <ul style="list-style-type: none"> – The parking control should result in an average car ownership of 0.9 cars per unit 	1.6, 5.5
D.2	Update minimum bicycle parking controls for Residential - Flat Buildings and Shop Top Housing <ul style="list-style-type: none"> – Update controls to require one bicycle space per unit – Update controls to require that bicycle parking is not allocated to individual units but managed by Strata 	1.6, 5.5
D.3	Require Green Travel Plans be prepared for developments <ul style="list-style-type: none"> – Development applications for apartment buildings should require preparation of a green travel plan prior to occupation certificate 	N/A

Source: SCT Consulting, 2023

Cumberland City Council's current DCP control for Residential - Flat Buildings and Shop Top Housing is 1 bicycle parking space per 3 units. However, the national cycling participation survey indicates the following levels of ownership for Sydney (CWANZ, 2021):

- 45 per cent of households had no bicycles
- 17 per cent of households had one bicycle
- 16 per cent of households had two bicycles
- 21 per cent of households had three bicycles or more.

This translates to a bicycle ownership rate of 1.12 bicycles per household. Therefore, the current rate of bicycle parking provision for apartments in Westmead is too low to accommodate the potential bicycle ownership. It is recommended that the minimum bicycle parking be increase to one per unit, which replicates the control for City of Parramatta (City of Parramatta Council, 2023).

Because bicycle ownership is highly variable, access to bicycle parking should be “unbundled” or not associated with specific dwellings. This is reflected in the Cycling Participation Survey results, which show that a large proportion of households do not own a bicycle (45 per cent) while the remaining households are more likely to own two or more bicycles than just one (37 per cent vs 17 per cent).

It is recommended that the type of parking be AS2890.3 Table 1.1 User Class B, being a secure room/structure rather than individual lockers. The facility would have CCTV to prevent theft amongst users. Households with multiple bicycle parking spaces should be able to securely store multiple bicycles, assuming that there is sufficient capacity overall for all residents.

The National Construction Code now requires that 100% of car parking spaces in Class 2 (apartment) buildings are sized to support the future installation of a 7kW (32A) Type 2 EV charger. This ensures that any households desiring to own an electric vehicle may do so. The residents of Westmead therefore don't need any further facilitation of electric vehicle take-up. Therefore, the National Construction Code addresses TfNSW initiative 1.4.

7.0 Performance evaluation

7.1 Performance metrics

The evaluation of the proposed upgrades from **Section 4.5** requires a multi-modal lens. The following performance metrics are evaluated for the transport solution:

- Mode share
- Distance to cycling network
- Public transport accessibility level
- % tree canopy
- Average footpath width
- Vehicle travel speeds
- Level of Service.

The approach to performance measurement is not focussing on intersection Level of Service, which only measures performance in one mode and doesn't capture how intersections typically operate in highly urban areas.

Intersection Level of Service (LoS) is a tool to measure the level of congestion at an intersection as well as to identify locations requiring further investigations. The LoS as defined in the Traffic Modelling Guidelines is summarised in **Table 7-1**.

Table 7-1 Level of Service definitions

Level of Service (LoS)	Average Delay per Vehicles (sec/h)	Performance explanation
A	Less than 14.5	Good operation
B	14.5 to 28.4	Good with acceptable delays and spare capacity
C	28.5 to 42.4	Satisfactory
D	42.5 to 56.4	Operating near capacity
E	56.5 to 70.4	At capacity, at signals incidents will cause excessive delays. Roundabouts require other control method.
F	70.5 or greater	At capacity, at signals incidents will cause excessive delays. Roundabouts require other control method.

Source: Roads and Maritime Services, 2002

Intersection Degree of Saturation (DoS) is another metric to measure the performance of isolated intersections and approaches. DS is a ratio of traffic demand to capacity. For intersections controlled by traffic signals, both queue length and delays typically increase rapidly as DoS approaches 1.0. The Traffic Modelling Guidelines identified an upper limit of 0.9 for signalised intersections.

7.2 Model scope

A SIDRA Network model was developed for testing of road network operational performance metrics. SIDRA Network is an analytical approach to the measurement of performance for the road network. This means that delays, queue lengths and blocking impacts between intersections are based on a collection of empirically validated equations.

The existing conditions performance was based on traffic surveys conducted on 27 June 2023 and 2 August 2023. Intersection turning volumes (the number of vehicles turning left, through and right at each road) and queue length surveys were collected to inform the SIDRA Network model.

A total of 14 intersections were modelled, with the locations shown in **Figure 7-1**. The intersections modelled were:

- Bridge Road / Riviera Park entry
- Bridge Road / Alexandra Avenue

- Bridge Road / Grand Avenue
- Bridge Road / Austral Avenue
- Hawkesbury Road / Railway Parade
- Hawkesbury Road / Alexandra Avenue
- Hawkesbury Road / Priddle Street
- Hawkesbury Road / Austral Avenue
- Hawkesbury Road / Church Avenue
- Hawkesbury Road / Nolan Crescent
- Alexandra Avenue / Hassall Street
- Hassall Street / Pye Street
- Great Western Highway / Bridge Road
- Great Western Highway / Hawkesbury Road

TfNSW supplied traffic signal data for each of the traffic signals that were modelled. Existing conditions models were validated to match existing queue lengths to a reasonable level of accuracy.

7.3 Future year assumptions

7.3.1 Background growth assumptions

The Westmead Place Strategy supporting Transport Strategy Strategic Diction 5.3 is **Reduce Westmead’s attractiveness to through traffic.**

Future year background growth was requested from the Strategic Traffic Forecasting Model (STFM) as the first step in understanding the potential future state for Westmead. The demand flows showed a substantial demand for through traffic in Westmead. The forecast showed a different trend to TfNSW’s traffic volume viewer for Hawkesbury Road and Great Western Highway. Both experienced a decline in traffic volumes since data started recording.

Figure 7-2 Traffic volume viewer data for relevant roads

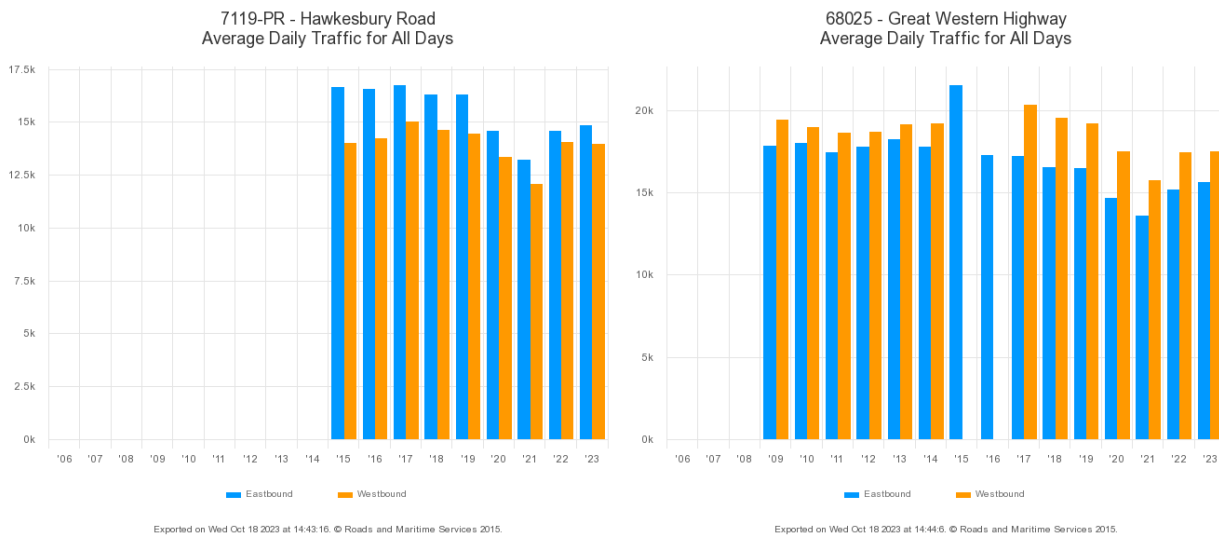

Source: TfNSW, 2023

This frequently occurs in highly urban areas. Strategic models identify that there is a demand for much greater levels of car driving than actually occurs in the network.

Adopting and planning for growth that would never occur reinforces car dependency and rarely results in a network with low congestion. In contrast, the desired future state for Westmead South is a network that prioritises walking and cycling access to Westmead Station.

The growth forecasts adopted for the precinct are therefore:

- Great Western Highway was forecast to experience a 0.5% per annum growth from 2023 surveys to the 2041 assumed completion of the master plan
- All other roads would not experience a growth in traffic.

Hawkesbury Road can’t accommodate a growth in traffic associated with Westmead Innovation District to the north due to the limited capacity of the intersections outside of Westmead Station. Sydney Metro forecasts 4,100 pedestrians per hour in the morning peak, which would mean that any vehicle growth through this corridor is not feasible.

7.3.2 Traffic generation rates

The traffic generation rates adopted for this study are 0.134 vehicles per hour per parking space and 0.2 vehicles per hour per parking space. This rate is extracted from Trip Generation Surveys High Density Residential (Car Based) Analysis Report (Bitzios, 2017). Trip generation rates were adopted from the ‘Metropolitan Sites’ category based on similarity with other metropolitan sites (e.g. Wentworth Point and Parramatta had sites, both of which are located further away from transit than Westmead South).

Analysis by Bitzios found that predicting traffic by parking space was a more robust method of forecasting traffic than using the number of dwellings.

The traffic generated under each of the scenarios is provided in **Table 7-2**.

Table 7-2 Traffic generated by uplift

Peak	Generation rate	Parking spaces	Traffic generated
Option 1: Current parking controls			
AM	0.134 veh/h/parking space	1.4 parking spaces per unit average	+1,456
PM	0.2 veh/h/parking space	Additional 7,763 apartments 10,868 additional parking spaces	+2,174
Option 2: Maximum parking controls			
AM	0.134 veh/h/parking space	0.9 parking spaces per unit average	+936
PM	0.2 veh/h/parking space	Additional 7,763 apartments 6,986 additional parking spaces	+1,397

The proposed parking controls targeting 0.9 parking spaces per unit reduces the number of parking spaces proposed in Westmead South by 3,882 parking spaces. The reduction in traffic generation is therefore a 36% reduction.

7.4 Need for scenario testing

The transport approach for Westmead South is transformative. The type of transport offering at the future Westmead South will look different to many of other centres in Cumberland City.

Scenario testing was conducted to quantify the benefits of this transformative approach. Parking controls are considered the most sizeable change. Cumberland City Council's other centres generally have minimum parking controls, but this strategy proposes a shift to maximum parking controls. Maximum parking controls would translate to reduced development costs and road network congestion. Rather than simply adopt these changes, this transport study measures the concrete differences in infrastructure needs and network congestion so Council can make an informed decision and the community can understand the policy trade-offs.

7.5 Existing conditions scenario

7.5.1 Assumptions

The road network layout incorporated in SIDRA Network are provided in **Table 7-3**.

Demands were based on intersection turning count surveys conducted on 27 June 2023 and 2 August 2023. Traffic signal data was supplied by TfNSW for the same time period. The network assumptions were updated to align the modelled and surveyed queue lengths at each intersection.

Table 7-3 Existing conditions infrastructure assumptions

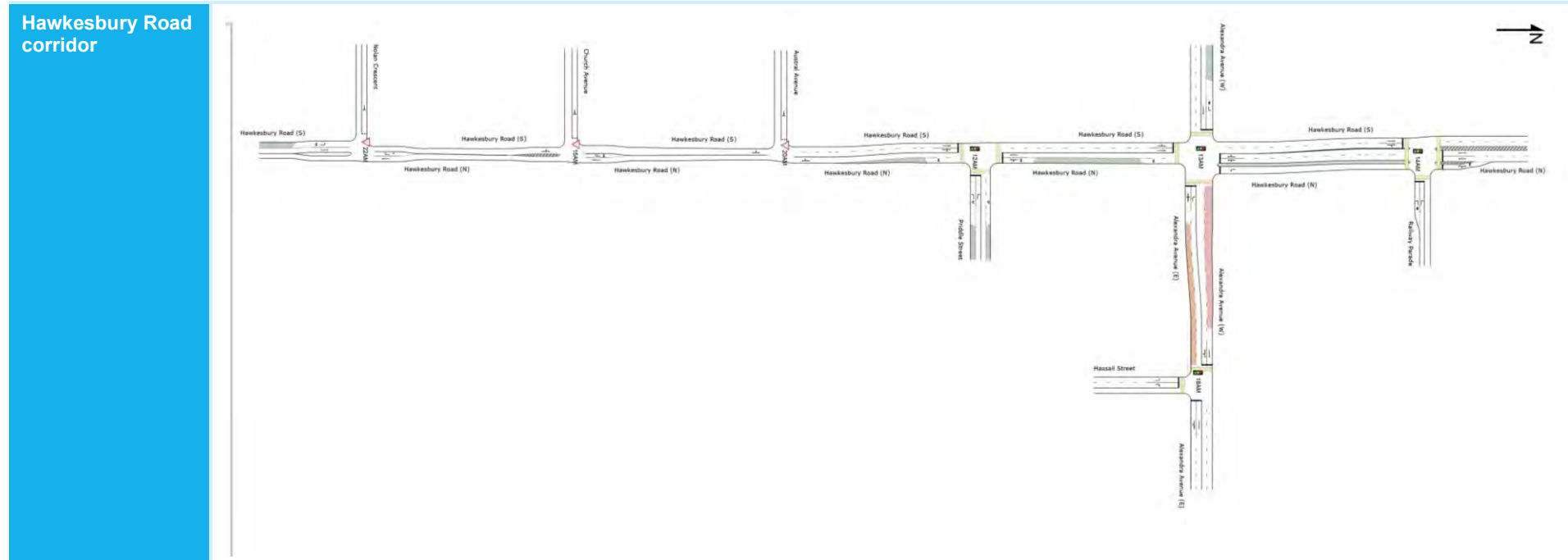

Bridge Road corridor



Great Western Highway corridor

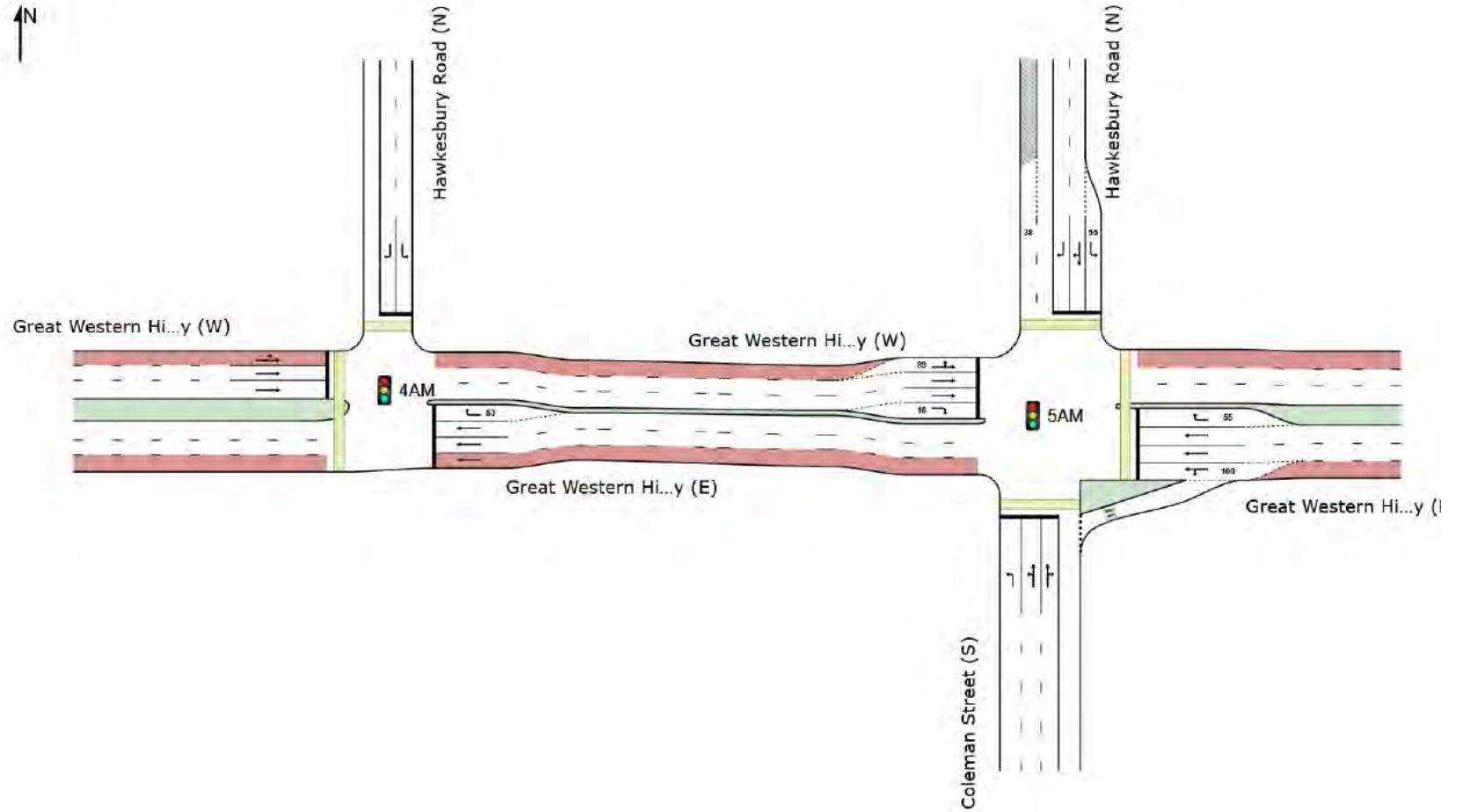

7.5.2 Network performance

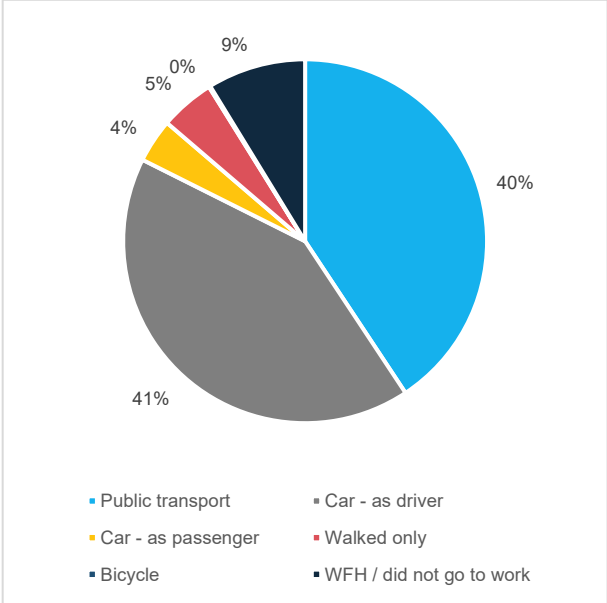
Mode share	Distance to cycling network	Public transport accessibility level																											
 <p>Car drive mode share 41%</p>	<p>Argyle Street cycleway touches the eastern boundary No cycling network for residents within Westmead</p>	<p>Raw score 24.5</p> <p>5 – Very good</p>																											
	Tree canopy coverage	Average footpath width																											
	<p>Streets are in the 0-40% tree canopy coverage category</p>	<p>1.25m average footpath width based on Council's asset database</p>																											
Hawkesbury Road speed	Great Western Highway speed	Bridge Road speed																											
<table border="1"> <thead> <tr> <th></th> <th>AM</th> <th>PM</th> </tr> </thead> <tbody> <tr> <td>Northbound</td> <td>21km/h</td> <td>25km/h</td> </tr> <tr> <td>Southbound</td> <td>23km/h</td> <td>21km/h</td> </tr> </tbody> </table>		AM	PM	Northbound	21km/h	25km/h	Southbound	23km/h	21km/h	<table border="1"> <thead> <tr> <th></th> <th>AM</th> <th>PM</th> </tr> </thead> <tbody> <tr> <td>Eastbound</td> <td>43km/h</td> <td>40km/h</td> </tr> <tr> <td>Westbound</td> <td>37km/h</td> <td>36km/h</td> </tr> </tbody> </table>		AM	PM	Eastbound	43km/h	40km/h	Westbound	37km/h	36km/h	<table border="1"> <thead> <tr> <th></th> <th>AM</th> <th>PM</th> </tr> </thead> <tbody> <tr> <td>Northbound</td> <td>28km/h</td> <td>27km/h</td> </tr> <tr> <td>Southbound</td> <td>32km/h</td> <td>19km/h</td> </tr> </tbody> </table>		AM	PM	Northbound	28km/h	27km/h	Southbound	32km/h	19km/h
	AM	PM																											
Northbound	21km/h	25km/h																											
Southbound	23km/h	21km/h																											
	AM	PM																											
Eastbound	43km/h	40km/h																											
Westbound	37km/h	36km/h																											
	AM	PM																											
Northbound	28km/h	27km/h																											
Southbound	32km/h	19km/h																											

7.5.3 Intersection performance

The intersection performance of each intersection assessed in SIDRA is provided in **Table 7-4**.

Table 7-4 Existing conditions intersection performance

Network	Site name	Existing conditions scenario AM peak			Existing conditions scenario PM peak		
		DoS	Delay	LoS	DoS	Delay	LoS
Hawkesbury Road Network	Hawkesbury Road / Railway Parade	0.45	14.0	A	0.93	36.6	C
	Hawkesbury Road / Alexandra Avenue	0.76	29.2	C	1.01	48.7	D
	Hawkesbury Road / Priddle Street	0.43	20.1	B	0.57	10.1	A
	Hawkesbury Road / Nolan Crescent	0.40	66.8	E	0.36	13.3	A
	Hawkesbury Road / Church Street	0.31	63.3	E	0.35	11.5	A
	Hawkesbury Road / Austral Avenue	0.35	12.1	A	0.37	12.9	A
	Alexandra Avenue Hassall Street	0.48	14.0	A	0.53	12.2	A
Bridge Road Network	Bridge Street / Monarco Estate entry	0.36	10.5	A	1.06	68.8	E
	Bridge Road / Alexandra Avenue	0.71	12.1	A	1.13	135.6	F
	Bridge Road / Grand Avenue	0.70	18.8	B	0.79	23.5	B
Great Western Highway Network	Great Western Highway / Bridge Road	0.69	15.9	B	0.66	13.6	A
	Great Western Highway / Hawkesbury Road	0.76	36.0	C	0.87	36.5	C

Source: SCT Consulting, 2023

Intersection performance in the study area is generally between Level of Service A – D, though Hawkesbury Road and Bridge Road both have intersections which operate at Level of Service E or F during one of the peak periods. The intersections operating at greater levels of congestion are all priority controlled (give way, stop or roundabout) rather than traffic signals.

7.6 Scenario 1: Current parking controls

7.6.1 Assumptions

This scenario is based on a traffic generation rate of 0.134 vehicles per hour per parking space and 0.2 vehicles per hour per parking space. The number of parking spaces in Scenario 1 is 1.4 spaces per unit average, which is 10,868 additional parking spaces.

The road upgrades required to support this scenario are provided in **Table 7-5**.

Table 7-5 Infrastructure upgrades for Scenario 1 and 2

Road upgrades		
<ul style="list-style-type: none"> – Hawkesbury Rd loses southbound short lane south of Alexandra Avenue to enable on-road cycling route. 	<ul style="list-style-type: none"> – Left turn slip from Bridge Rd to GWH – Hawkesbury Rd two lanes northbound for 80m. – Remove right turn from GWH into Coleman St – Convert through lane on GWH east of Hawkesbury Rd to right turn – Left turn slip from Coleman St to GWH 	<ul style="list-style-type: none"> – Right turn ban for Veron St. – Bridge Rd between Alexandra Ave and Austral Ave needs a four-lane cross section.

Signal timings were optimised for each scenario but were also set to be similar between Scenario 1 and 2 to allow a like for like comparison.

Background growth was set as zero for almost all zones, except those along Great Western Highway or Coleman Street, which were set to 0.5% per annum compound growth rate. The future year of modelling is assumed to be 2041, when all dwellings are completed.

Detailed intersection layouts are provided overleaf.

Hawkesbury Road corridor

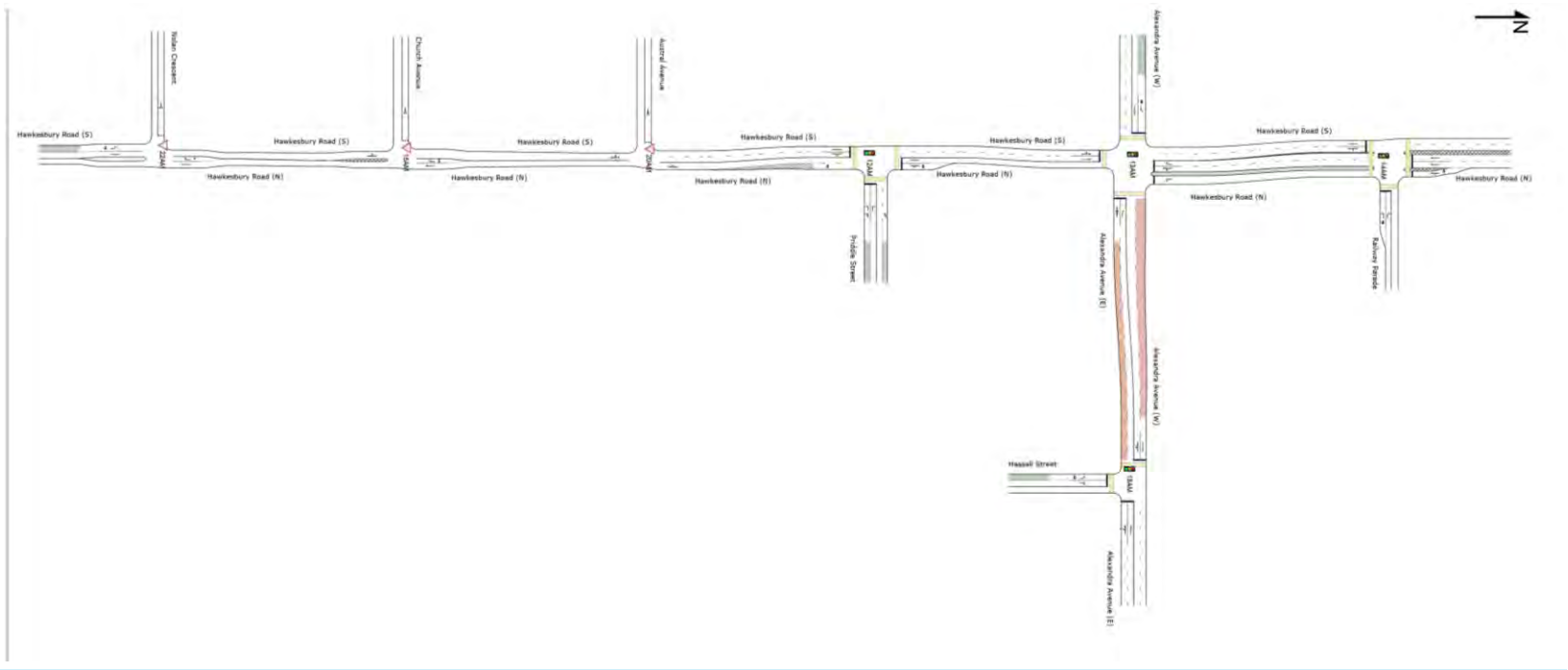

Bridge Road corridor



Great Western Highway corridor

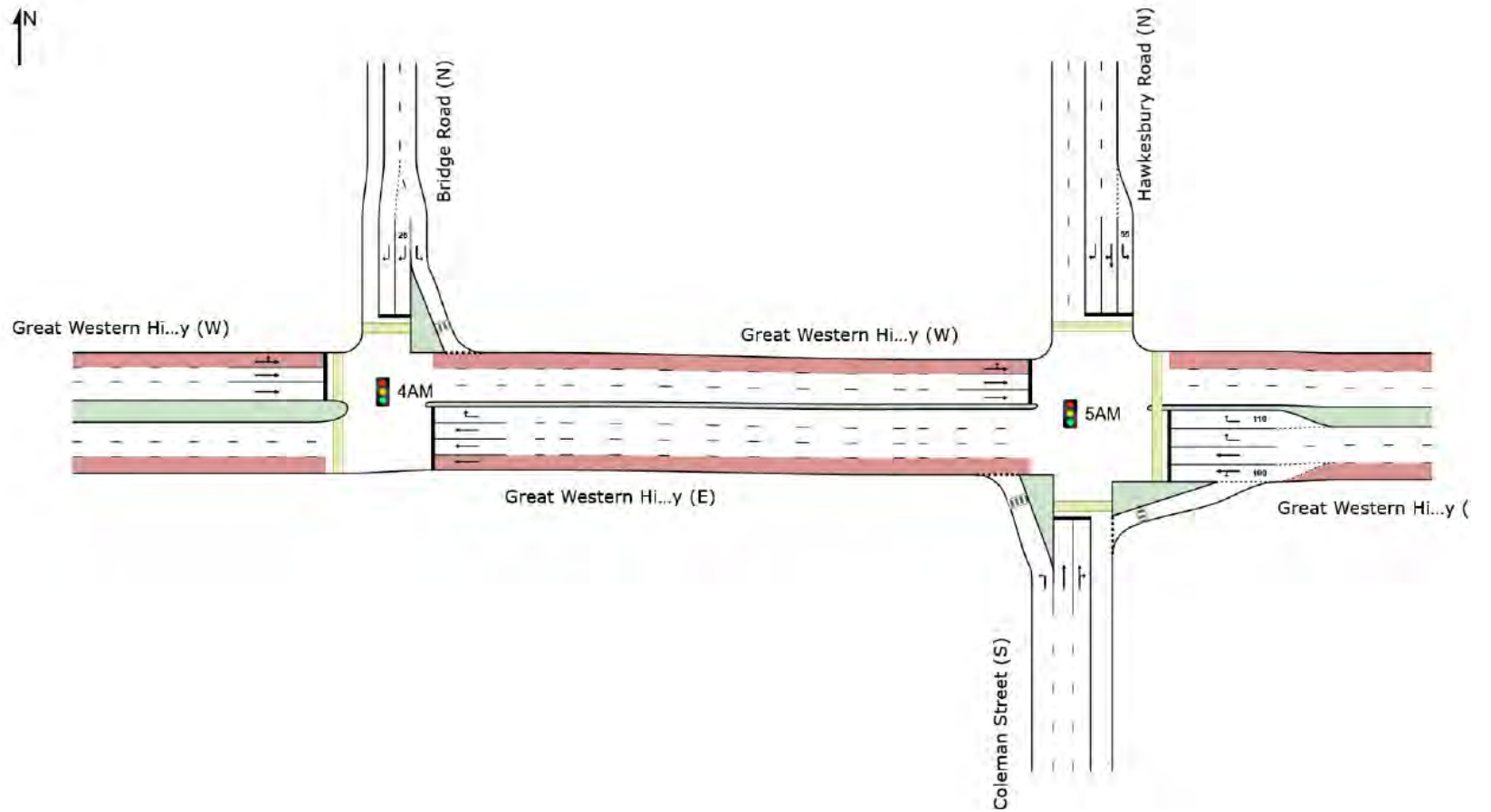

7.6.2 Network performance

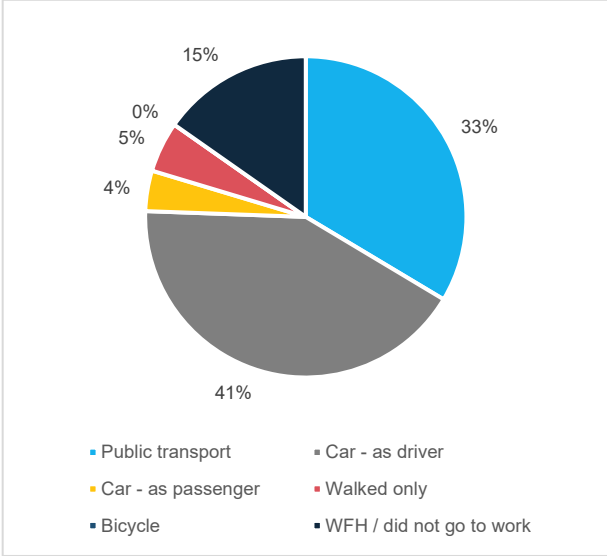
Mode share			Distance to cycling network			Public transport accessibility level		
 <p>Car drive mode share 41%</p>			Argyle Street cycleway touches the eastern boundary No cycling network for residents within Westmead			Raw score 28.6		
						6 – Excellent		
			Tree canopy coverage			Average footpath width		
			Streets are in the 0-40% tree canopy coverage category			1.41m average footpath width (increase of 20cm on average) based on proposed increased footpath widths		
Hawkesbury Road speed			Great Western Highway speed			Bridge Road speed		
	AM	PM		AM	PM		AM	PM
Northbound	13 km/h	20 km/h	Eastbound	18 km/h	37km/h	Northbound	28km/h	34km/h
Southbound	25 km/h	22 km/h	Westbound	48 km/h	17km/h	Southbound	32km/h	13km/h
Road upgrades								
<ul style="list-style-type: none"> Hawkesbury Rd loses southbound short lane south of Alexandra Avenue to enable on-road cycling route. 			<ul style="list-style-type: none"> Left turn slip from Bridge Rd to GWH Hawkesbury Rd two lanes northbound for 80m. Remove right turn from GWH into Coleman St Convert through lane on GWH east of Hawkesbury Rd to right turn Left turn slip from Coleman St to GWH 			<ul style="list-style-type: none"> Right turn ban for Veron St. Bridge Rd between Alexandra Ave and Austral Ave needs a four-lane cross section. 		

7.6.3 Intersection performance

The intersection performance of each intersection assessed in SIDRA is provided in **Table 7-6**.

Table 7-6 Scenario 1: Current parking controls intersection performance

Network	Site name	Scenario 1 performance AM peak			Scenario 1 performance PM peak		
		DoS	Delay	LoS	DoS	Delay	LoS
Hawkesbury Road Network	Hawkesbury Road / Railway Parade	0.49	19.4	B	0.63	22.4	B
	Hawkesbury Road / Alexandra Avenue	1.14	127.7	F	1.13	105.4	F
	Hawkesbury Road / Priddle Street	0.25	16.4	B	2.31	217.8	F
	Hawkesbury Road / Nolan Crescent	0.27	11.0	A	0.23	8.7	A
	Hawkesbury Road / Church Street	0.25	9.5	A	0.18	6.1	A
	Hawkesbury Road / Austral Avenue	0.23	5.7	A	0.17	6.3	A
	Alexandra Avenue Hassall Street	1.41	346.5	F	1.19	158.7	F
Bridge Road Network	Bridge Street / Monarco Estate entry	0.48	9.4	A	1.03	36.8	C
	Bridge Road / Alexandra Avenue	1.16	161.3	F	3.13	1932.3	F
	Bridge Road / Grand Avenue	0.60	15.8	B	0.71	16.0	B
Great Western Highway Network	Great Western Highway / Bridge Road	1.29	140.4	F	1.27	88.7	F
	Great Western Highway / Hawkesbury Road	0.97	52.4	D	2.34	363.9	F

Source: SCT Consulting, 2023

7.7 Scenario 2: Maximum parking controls

7.7.1 Assumptions

This scenario is based on a traffic generation rate of 0.134 vehicles per hour per parking space and 0.2 vehicles per hour per parking space. The number of parking spaces in Scenario 1 is 0.9 spaces per unit average, which is 6,986 parking spaces.

The road upgrades required to support this scenario are provided in **Table 7-8**.

Table 7-7 Infrastructure upgrades for Scenario 1 and 2

Road upgrades		
<ul style="list-style-type: none"> – Hawkesbury Rd loses southbound short lane south of Alexandra Avenue to enable on-road cycling route. 	<ul style="list-style-type: none"> – Left turn slip from Bridge Rd to GWH – Hawkesbury Rd two lanes northbound for 80m. – Remove right turn from GWH into Coleman St – Convert through lane on GWH east of Hawkesbury Rd to right turn – Left turn slip from Coleman St to GWH 	<ul style="list-style-type: none"> – Right turn ban for Veron St. – Bridge Rd between Alexandra Ave and Austral Ave needs a four-lane cross section.

Signal timings were optimised for each scenario but were also set to be similar between Scenario 1 and 2 to allow a like for like comparison.

Background growth was set as zero for almost all zones, except those along Great Western Highway or Coleman Street, which were set to 0.5% per annum compound growth rate. The future year of modelling is assumed to be 2041, when all dwellings are completed.

7.7.2 Network performance

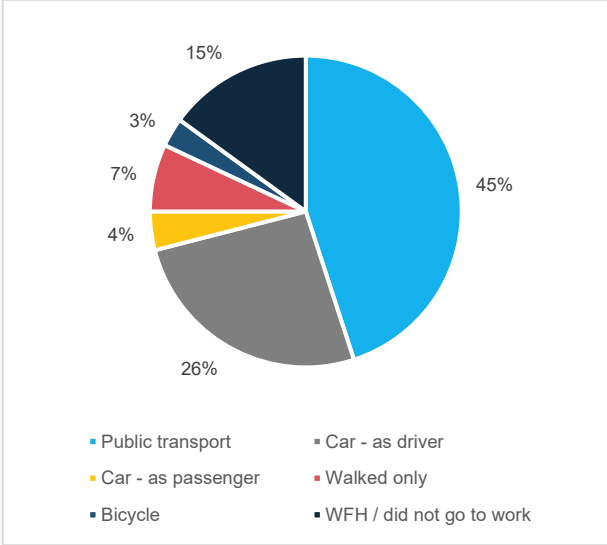
<p>Mode share</p>	<p>Distance to cycling network</p>	<p>Public transport accessibility level</p>																											
 <p>26 % car driver mode share</p>	<p>Argyle Street cycleway touches the eastern boundary No cycling network for residents within Westmead</p>	<p>Raw score 28.6</p> <p>6 – Excellent</p>																											
<p>Tree canopy coverage</p>	<p>Streets are in the 0-40% tree canopy coverage category</p>	<p>Average footpath width</p>																											
		<p>1.41m average footpath width (increase of 20cm on average) based on proposed increased footpath widths</p>																											
<p>Hawkesbury Road speed</p>	<p>Great Western Highway speed</p>	<p>Bridge Road speed</p>																											
<table border="1"> <thead> <tr> <th></th> <th>AM</th> <th>PM</th> </tr> </thead> <tbody> <tr> <td>Northbound</td> <td>13km/h</td> <td>26km/h</td> </tr> <tr> <td>Southbound</td> <td>25km/h</td> <td>24km/h</td> </tr> </tbody> </table>		AM	PM	Northbound	13km/h	26km/h	Southbound	25km/h	24km/h	<table border="1"> <thead> <tr> <th></th> <th>AM</th> <th>PM</th> </tr> </thead> <tbody> <tr> <td>Eastbound</td> <td>21km/h</td> <td>37km/h</td> </tr> <tr> <td>Westbound</td> <td>49km/h</td> <td>17km/h</td> </tr> </tbody> </table>		AM	PM	Eastbound	21km/h	37km/h	Westbound	49km/h	17km/h	<table border="1"> <thead> <tr> <th></th> <th>AM</th> <th>PM</th> </tr> </thead> <tbody> <tr> <td>Northbound</td> <td>28km/h</td> <td>34km/h</td> </tr> <tr> <td>Southbound</td> <td>32km/h</td> <td>13km/h</td> </tr> </tbody> </table>		AM	PM	Northbound	28km/h	34km/h	Southbound	32km/h	13km/h
	AM	PM																											
Northbound	13km/h	26km/h																											
Southbound	25km/h	24km/h																											
	AM	PM																											
Eastbound	21km/h	37km/h																											
Westbound	49km/h	17km/h																											
	AM	PM																											
Northbound	28km/h	34km/h																											
Southbound	32km/h	13km/h																											

7.7.3 Intersection performance

The intersection performance of each intersection assessed in SIDRA is provided in **Table 7-8**.

Table 7-8 Scenario 2: Current parking controls intersection performance

Network	Site name	Scenario 2 performance AM peak			Scenario 2 performance PM peak		
		DoS	Delay	LoS	DoS	Delay	LoS
Hawkesbury Road Network	Hawkesbury Road / Railway Parade	0.48	19.9	B	0.56	20.0	B
	Hawkesbury Road / Alexandra Avenue	1.12	117.7	F	1.19	109.0	F
	Hawkesbury Road / Priddle Street	0.24	16.1	B	2.29	223.1	F
	Hawkesbury Road / Nolan Crescent	0.27	10.5	A	0.20	8.1	A
	Hawkesbury Road / Church Street	0.25	9.3	A	0.17	6.1	A
	Hawkesbury Road / Austral Avenue	0.23	5.7	A	0.17	6.3	A
	Alexandra Avenue Hassall Street	1.25	231.9	F	0.81	30.5	C
Bridge Road Network	Bridge Street / Monarco Estate entry	0.47	9.4	A	1.03	37.0	C
	Bridge Road / Alexandra Avenue	0.94	25.6	B	2.71	1552.8	F
	Bridge Road / Grand Avenue	0.56	15.5	B	0.71	16.0	B
Great Western Highway Network	Great Western Highway / Bridge Road	1.29	135.7	F	1.17	63.7	E
	Great Western Highway / Hawkesbury Road	1.06	53.4	D	1.94	307.9	F

Source: SCT Consulting, 2023

7.8 Discussion

The travel time performance shows a significant decline, particularly for Great Western Highway in the direction of peak travel (eastbound in the morning and westbound in the evening).

A comparison of travel times side by side is provided in **Table 7-9**.

Table 7-9 Comparison of travel times

Route	Existing conditions	With development	
		Scenario 1: existing parking controls	Scenario 2: maximum parking controls
AM			
Hawkesbury Road northbound	21km/h	13km/h (-8km/h)	13km/h (-8km/h)
Hawkesbury Road southbound	22km/h	25km/h (+3km/h)	25km/h (+3km/h)
GWH eastbound	43km/h	18km/h (-25km/h)	21km/h (-22km/h)
GWH westbound	37km/h	48km/h (+11km/h)	49km/h (+12km/h)
Bridge Road northbound	28km/h	28km/h	28km/h
Bridge Road southbound	31km/h	32km/h(+1km/h)	32km/h (+1km/h)
PM			
Hawkesbury Road northbound	25km/h	20km/h (-5km/h)	26km/h (+1km/h)
Hawkesbury Road southbound	17km/h	22km/h (+5km/h)	24km/h (+7km/h)
GWH eastbound	40km/h	37km/h (-3km/h)	37km/h (-3km/h)
GWH westbound	36km/h	17km/h (-19km/h)	17km/h (-19km/h)
Bridge Road northbound	27km/h	34km/h (+7km/h)	34km/h (+7km/h)
Bridge Road southbound	8km/h	13km/h (+5km/h)	13km/h (+5km/h)

The introduction of the draft Westmead South Master Plan results in:

- **Hawkesbury Road:** generally slower travel times northbound and faster travel times southbound
- **Great Western Highway:** generally slower in both directions except for the westbound direction in the morning peak
- **Bridge Road:** either no change or slight improvements to northbound travel times and generally improved travel times southbound.

The improvements to Bridge Road are a result of the widening proposal to a four lane cross section. Bridge Road accommodates an increase in traffic without an increase in delays.

Great Western Highway experiences a decline in performance due in part to the assumption that background traffic grows. Historical volumes show a general traffic decline over time. Despite the proposed upgrades to the network, travel times decline. A sensitivity test showed that an additional eastbound lane would largely return Great Western Highway to original travel speeds.

The impact of introducing maximum parking controls is a general reduction in corridor travel times. The travel time benefits are:

- Hawkesbury Road, travels 6km/h faster northbound and 2km/h faster southbound in the evening peak.
- Great Western Highway eastbound, experiences a 3km/h increase in travel speeds in the morning peak.

However, the differences observed are relatively slight – in the order of up to a 6km/h improvement. This is because traffic signals tend to prioritise the main corridor. Intersection levels of service are shown overleaf.

Table 7-10 Comparison of intersection performance across scenarios

Network	Site name	AM peak			PM peak		
		Existing	Scenario 1	Scenario 2	Existing	Scenario 1	Scenario 2
Hawkesbury Road Network	Hawkesbury Road / Railway Parade	A	B	B	C	B	B
	Hawkesbury Road / Alexandra Avenue	C	F	F	D	F	F
	Hawkesbury Road / Priddle Street	B	B	B	A	F	F
	Hawkesbury Road / Nolan Crescent	E	A	A	A	A	A
	Hawkesbury Road / Church Street	E	A	A	A	A	A
	Hawkesbury Road / Austral Avenue	A	A	A	A	A	A
	Alexandra Avenue / Hassall Street	A	F	F	A	F	C
Bridge Road Network	Bridge Street / Monarco Estate entry	A	A	A	E	C	C
	Bridge Road / Alexandra Avenue	A	F	B	F	F	F
	Bridge Road / Grand Avenue	B	B	B	B	B	B
Great Western Highway Network	Great Western Highway / Bridge Road	B	F	F	A	F	E
	Great Western Highway / Hawkesbury Road	C	D	D	C	F	F

The introduction of maximum parking controls results in:

- Bridge Road / Alexandra Avenue improving from Level of Service F to B (AM peak)
- Alexandra Avenue / Hassall Street improving from Level of Service F to C (PM peak)
- Great Western Highway / Bridge Road improving from Level of Service F to E (PM peak).

The typical intersection delay improves from 162 seconds with minimum parking controls to 126 seconds with maximum parking controls – a saving of 40 seconds per intersection.

The improved performance is a result of a reduction in traffic volumes across the study area. The parking controls reduce the traffic generation by 520 vehicles per hour in the morning peak and 780 vehicles per hour in the afternoon peak. There were no changes to signal timing or infrastructure layouts, so the change in congestion is purely associated with having less cars on the road.

Maximum parking controls therefore are recommended as the preferred scenario due to the congestion-saving benefits to current and future residents.

8.0 Conclusion

8.1 Study conclusions

The transport study for draft Westmead South Master Plan shows that:

- A suite of actions needs to be funded to support the successful delivery of the master plan. Actions are identified for infrastructure, road upgrades, Westmead South-specific development control plan items, and parking initiatives.
- The master plan caters for new major cycling and walking infrastructure which aligns with Sydney Metro and City of Parramatta's cycling network. The performance metrics show that the cycling changes are a major shift in cycling accessibility for residents.
- Maximum parking controls result in a significant reduction in congestion in Westmead. The most efficient road network layouts were identical regardless of what parking controls were adopted. However, the network travel times differed significantly, and the network performed better when fewer parking spaces were delivered.
- Hawkesbury Road will undergo a transition regardless of what is planned in Westmead South due to the significant increase in pedestrian demands arising from the Sydney Metro West station. Hawkesbury Road will have to cater for the large increase in pedestrian volumes, with a total forecast of 4,100 pedestrians per hour in the morning peak. By comparison, the number of vehicles currently is 2,000. That means that there could be twice the number of pedestrians as cars at this intersection. Over time, Hawkesbury Road needs to transition to a people not movement focussed road.
- Modelling shows that travel times on some corridors worsen with the project, most notably Great Western Highway. Due to the limited land available, further widening is not recommended.

8.2 Next steps

This report is an initial proposal for transport planning to support Westmead South and will accompany Council's exhibition to the community. This plan will evolve through community consultation and engagement with Government authorities such as Transport for NSW, School Infrastructure NSW and the Department of Planning and Environment.

APPENDIX A

PARKING
RESTRICTIONS
AND
OCCUPANCY

Legend

6AM on street parking occupancy

- <50%
- 50 - 80%
- 80 - 90%
- 90 - 100%
- Study boundary

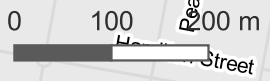

© SCT Consulting, OpenStreetMap contributors
Occupancy as on Wed 24 May 2023

Legend

9AM on street parking occupancy

- <50%
- 50 - 80%
- 80 - 90%
- 90 - 100%
- Study boundary

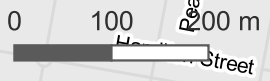

© SCT Consulting, OpenStreetMap contributors
Occupancy as on Wed 24 May 2023

Legend

12PM on street parking occupancy

- <50%
- 50 - 80%
- 80 - 90%
- 90 - 100%
- Study boundary

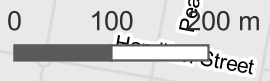

© SCT Consulting, OpenStreetMap contributors
Occupancy as on Wed 24 May 2023

Legend

3PM on street parking occupancy

- <50%
- 50 - 80%
- 80 - 90%
- 90 - 100%
- Study boundary



© SCT Consulting, OpenStreetMap contributors
Occupancy as on Wed 24 May 2023

Legend

6PM on street parking occupancy

- <50%
- 50 - 80%
- 80 - 90%
- 90 - 100%
- Study boundary

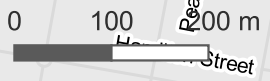

© SCT Consulting, OpenStreetMap contributors
Occupancy as on Wed 24 May 2023

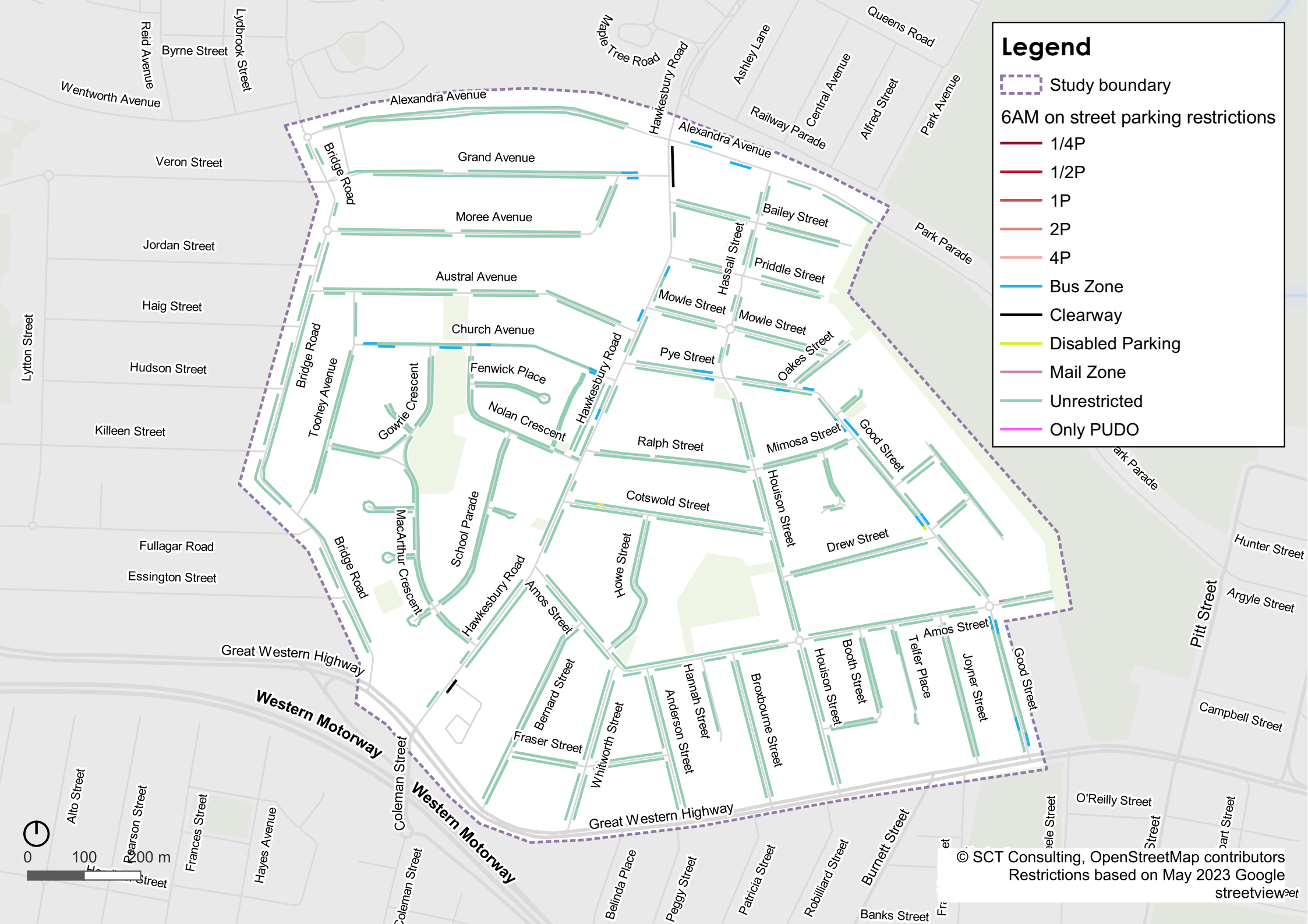

Legend

- Study boundary
- 6AM on street parking restrictions**
- 1/4P
- 1/2P
- 1P
- 2P
- 4P
- Bus Zone
- Clearway
- Disabled Parking
- Mail Zone
- Unrestricted
- Only PUDO

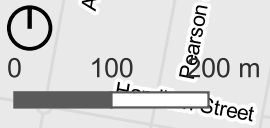

© SCT Consulting, OpenStreetMap contributors
 Restrictions based on May 2023 Google streetview



Legend

- Study boundary
- 9AM on street parking restrictions**
- 1/4P
- 1/2P
- 1P
- 2P
- 4P
- Bus Zone
- Clearway
- Disabled Parking
- Mail Zone
- Unrestricted
- Only PUDO

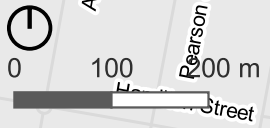

© SCT Consulting, OpenStreetMap contributors
 Restrictions based on May 2023 Google streetview



Legend

- Study boundary
- 12PM on street parking restrictions**
- 1/4P
- 1/2P
- 1P
- 2P
- 4P
- Bus Zone
- Clearway
- Disabled Parking
- Mail Zone
- Unrestricted
- Only PUDO



© SCT Consulting, OpenStreetMap contributors
 Restrictions based on May 2023 Google streetview



Legend

- Study boundary
- 3PM on street parking restrictions**
- 1/4P
- 1/2P
- 1P
- 2P
- 4P
- Bus Zone
- Clearway
- Disabled Parking
- Mail Zone
- Unrestricted
- Only PUDO



© SCT Consulting, OpenStreetMap contributors
 Restrictions based on May 2023 Google streetview

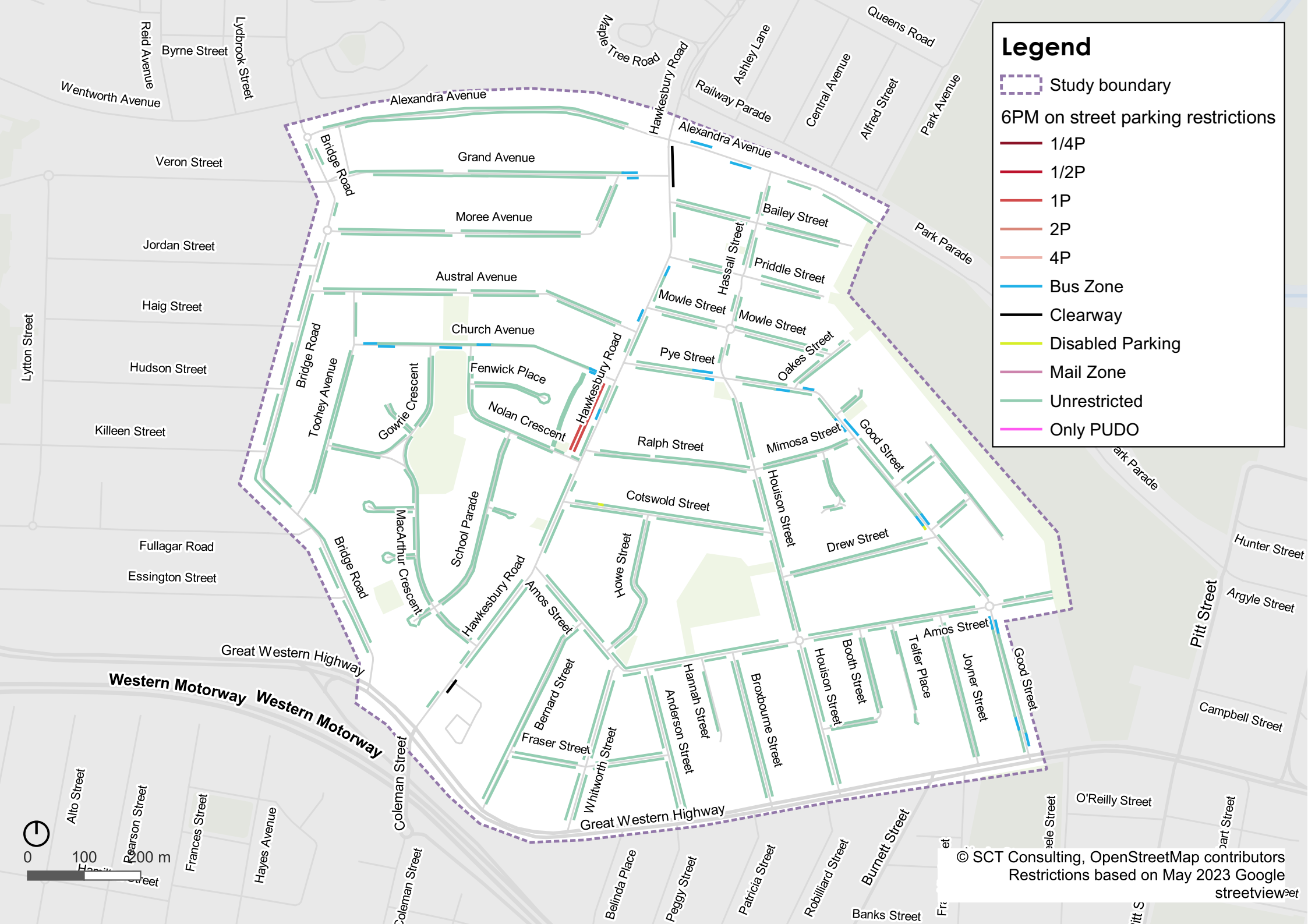

Legend

- Study boundary
- 6PM on street parking restrictions**
- 1/4P
- 1/2P
- 1P
- 2P
- 4P
- Bus Zone
- Clearway
- Disabled Parking
- Mail Zone
- Unrestricted
- Only PUDO



© SCT Consulting, OpenStreetMap contributors
 Restrictions based on May 2023 Google streetview

APPENDIX B

SIDRA
MOVEMENT
SUMMARIES

NETWORK LAYOUT

Network: N101 [Network 1 - AM (Network Folder: Base Year_DL)]

New Network
Network Category: (None)

Layout pictures are schematic functional drawings reflecting input data. They are not design drawings.

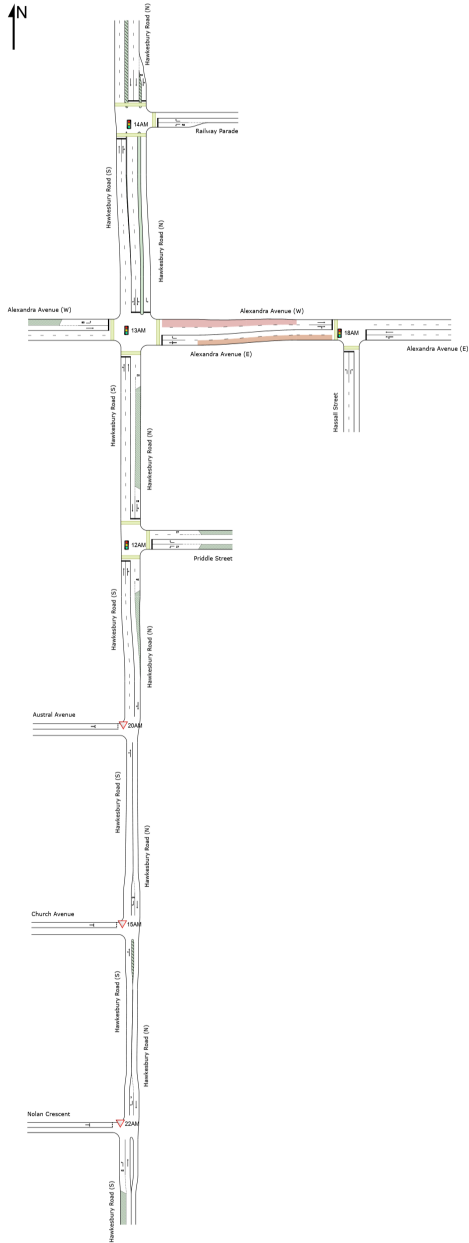

SITES IN NETWORK		
Site ID	CCG ID	Site Name
14AM	CCG1	HAW_RAI_23_14AM_DL
13AM	CCG1	HAW_ALE_23_13AM_DL
12AM	NA	HAW_PRI_23_12AM_DL
22AM	NA	HAW_NOL_23_22AM_DL
15AM	NA	HAW_CHU_23_15AM_DL
20AM	NA	HAW_AUS_23_20AM_DL
18AM	NA	ALE_HAS_23_18AM

NETWORK LAYOUT

Network: N101 [Network 2 - AM (Network Folder: Base Year_DL)]

New Network
 Network Category: (None)

Layout pictures are schematic functional drawings reflecting input data. They are not design drawings.

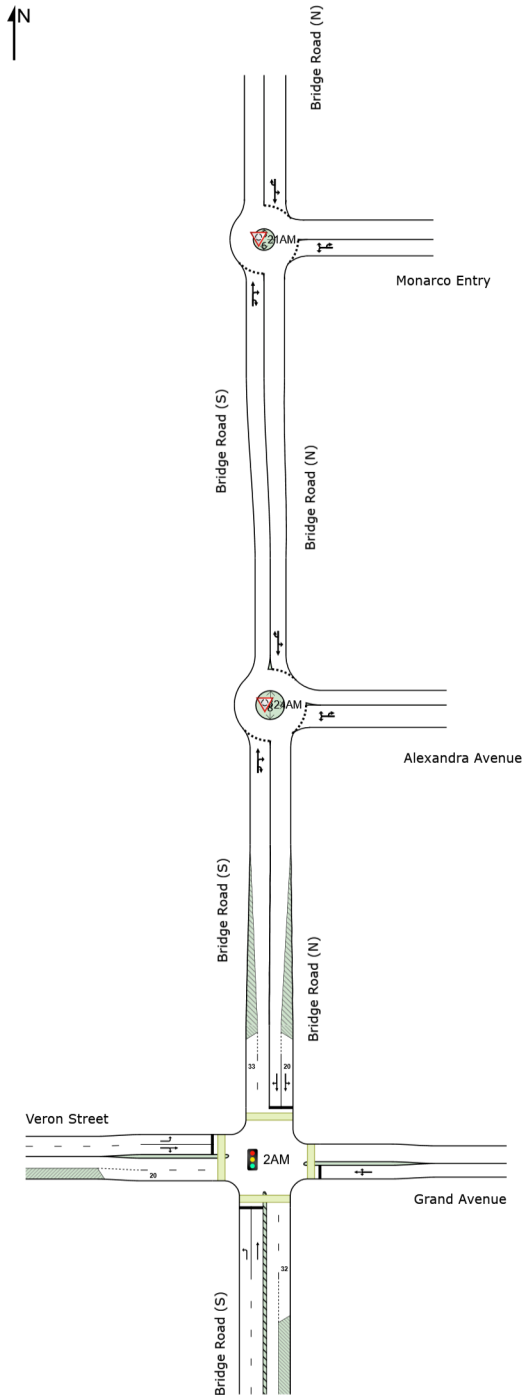

SITES IN NETWORK		
Site ID	CCG ID	Site Name
▽21AM	NA	BRI_MON_23_21AM_DL
▽24AM	NA	BRI_ALE_23_24AM_DL
🚦2AM	NA	BRI_GRA_23_2AM_DL

NETWORK LAYOUT

Network: N101 [Network 3 - AM (Network Folder: Base Year_DL)]

New Network
 Network Category: (None)

Layout pictures are schematic functional drawings reflecting input data. They are not design drawings.

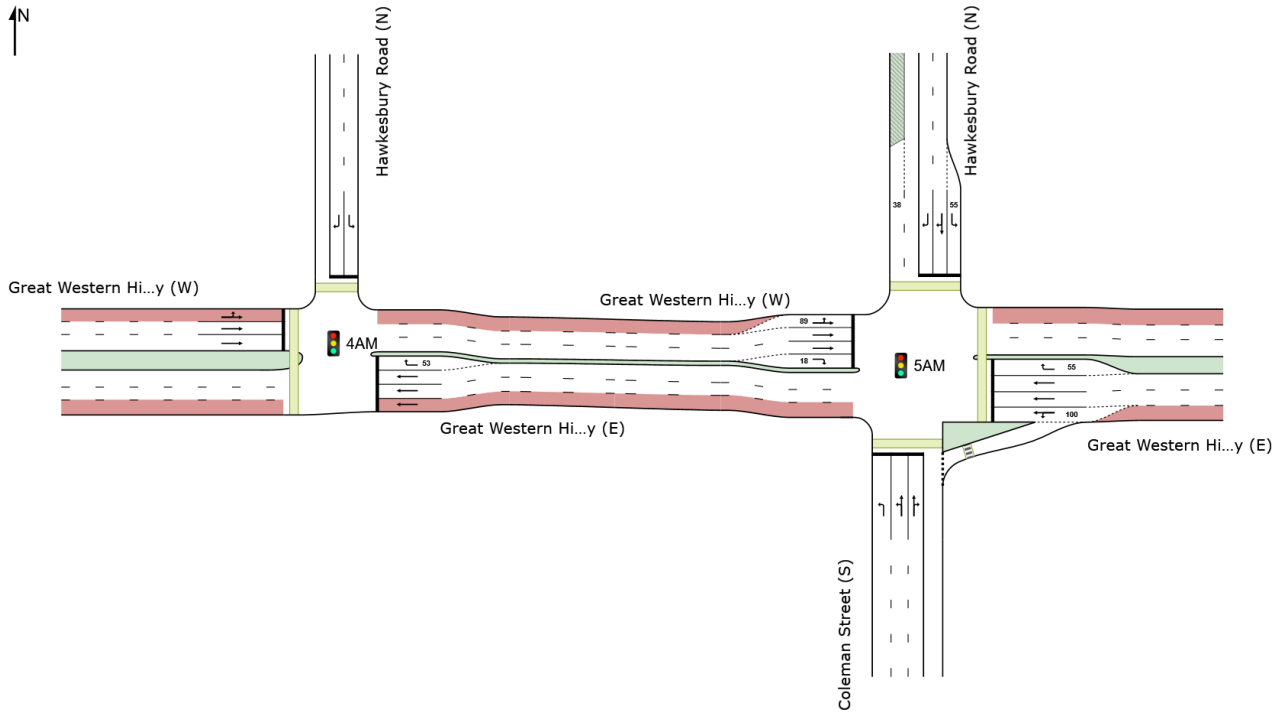

SITES IN NETWORK		
Site ID	CCG ID	Site Name
4AM	NA	BRI_GWH_23_4AM
5AM	NA	HAW_GWH_23_5AM_DL

SIDRA INTERSECTION 9.1 | Copyright © 2000-2023 Akcelik and Associates Pty Ltd | sidrasolutions.com
 Organisation: SCT CONSULTING PTY LTD | Licence: NETWORK / 1PC | Created: Thursday, 19 October 2023 4:30:21 PM
 Project: S:\Projects\SCT_00410_Cumberland Westmead Sth Transport Study\3. Technical Work Area\1. Network Optimisation
 \SCT_00410_Cumberland Westmead Sth_SIDRA_v0.5.sip9

CCG MOVEMENT SUMMARY

Common Control Group: CCG1 [TCS 1571]

Output produced by SIDRA INTERSECTION Version: 9.1.4.221

Network: N101 [Network 1 - AM (Network Folder: Base Year_DL)]

EQUISAT (Fixed-Time/SCATS) Coordinated Cycle Time = 111 seconds (Network User-Given Cycle Time)

Vehicle Movement Performance (CCG)															
Mov ID	Turn	Mov Class	Demand Flows		Arrival Flows		Deg. Satn	Aver. Delay	Level of Service	95% Back Of Queue		Prop. Que	Eff. Stop Rate	Aver. No. of Cycles	Aver. Speed
			[Total	HV]	[Total	HV]				[Veh.	Dist]				
			veh/h	%	veh/h	%	v/c	sec		veh	m			km/h	
Site: 14AM [HAW_RAI_23_14AM_DL]															
South: Hawkesbury Road (S)															
2	T1	All MCs	793	5.0	793	5.0	0.455	14.7	LOS B	12.4	89.8	0.76	0.52	0.76	21.3
3	R2	All MCs	211	2.8	211	2.8	*0.455	24.4	LOS B	12.4	89.8	0.78	0.67	0.78	30.9
Approach			1004	4.6	1004	4.6	0.455	16.7	LOS B	12.4	89.8	0.76	0.55	0.76	25.0
East: Railway Parade															
4	L2	All MCs	159	1.3	159	1.3	0.239	20.6	LOS B	4.9	34.6	0.61	0.69	0.61	29.3
6	R2	All MCs	14	28.6	14	28.6	0.054	45.3	LOS D	0.6	5.6	0.86	0.67	0.86	23.9
Approach			173	3.5	173	3.5	0.239	22.6	LOS B	4.9	34.6	0.63	0.69	0.63	28.7
North: Hawkesbury Road (N)															
7	L2	All MCs	70	0.0	70	0.0	0.179	28.8	LOS C	3.7	33.5	0.70	0.66	0.70	28.4
8	T1	All MCs	419	11.5	419	11.5	0.325	24.8	LOS B	8.7	62.6	0.73	0.62	0.73	13.5
Approach			489	9.8	489	9.8	0.325	25.4	LOS B	8.7	62.6	0.73	0.63	0.73	18.0
All Vehicles			1666	6.0	1666	6.0	0.455	19.9	LOS B	12.4	89.8	0.74	0.59	0.74	23.7
Site: 13AM [HAW_ALE_23_13AM_DL]															
South: Hawkesbury Road (S)															
1	L2	All MCs	15	0.0	15	0.0	1.001	58.9	LOS E	20.7	147.5	1.00	1.22	1.37	25.0
2	T1	All MCs	558	2.2	558	2.2	*1.001	54.3	LOS D	20.7	147.5	1.00	1.22	1.37	10.1
Approach			573	2.1	573	2.1	1.001	54.4	LOS D	20.7	147.5	1.00	1.22	1.37	10.7
East: Alexandra Avenue (E)															
4	L2	All MCs	27	3.7	27	3.7	0.809	56.1	LOS D	14.4	105.1	1.00	0.97	1.17	9.8
5	T1	All MCs	105	0.0	105	0.0	0.809	49.3	LOS D	14.4	105.1	1.00	0.97	1.17	26.4
6	R2	All MCs	295	10.5	295	10.5	0.809	55.7	LOS D	14.4	105.1	1.00	0.97	1.21	9.4

Approach			427	7.5	427	7.5	0.809	54.2	LOS D	14.4	105.1	1.00	0.97	1.20	15.3
North: Hawkesbury Road (N)															
7	L2	All MCs	217	18.0	217	18.0	0.591	9.3	LOS A	11.9	85.6	0.47	0.62	0.47	13.8
8	T1	All MCs	314	3.2	314	3.2	0.591	23.4	LOS B	11.9	85.6	0.65	0.68	0.65	9.0
9	R2	All MCs	47	2.1	47	2.1	0.473	79.0	LOS F	6.3	45.2	0.99	0.80	0.99	23.9
Approach			578	8.7	578	8.7	0.591	22.6	LOS B	11.9	85.6	0.61	0.67	0.61	14.1
West: Alexandra Avenue (W)															
10	L2	All MCs	151	2.0	151	2.0	* 0.589	25.3	LOS B	4.0	28.4	0.86	0.80	0.86	32.4
11	T1	All MCs	267	0.4	267	0.4	* 0.662	40.2	LOS C	13.0	91.4	0.94	0.79	0.94	27.0
Approach			418	1.0	418	1.0	0.662	34.8	LOS C	13.0	91.4	0.91	0.79	0.91	28.7
All Vehicles			1996	4.9	1996	4.9	1.001	41.1	LOS C	20.7	147.5	0.87	0.92	1.02	17.2

Site Level of Service (LOS) Method: Delay (RTA NSW). Site LOS Method is specified in the Network Data dialog (Override Site Data tab).

Vehicle movement LOS values are based on average delay per movement.

Intersection and Approach LOS values are based on average delay for all vehicle movements.

Delay Model: SIDRA Standard (Control Delay: Geometric Delay is included).

Gap-Acceptance Capacity Formula: SIDRA Standard (Akçelik M3D).

HV (%) values are calculated for All Movement Classes of All Heavy Vehicle Model Designation.

Arrival Flows used in performance calculations are adjusted to include any Initial Queued Demand and Upstream Capacity Constraint effects.

* Critical Movement (Signal Timing)

Pedestrian Movement Performance (CCG)											
Mov ID	Crossing	Dem. Flow ped/h	Aver. Delay sec	Level of Service	AVERAGE BACK OF QUEUE [Ped Dist]		Prop. Que	Eff. Stop Rate	Travel Time sec	Travel Dist. m	Aver. Speed m/sec
Site: 14AM [HAW_RAI_23_14AM_DL]											
South: Hawkesbury Road (S)											
P1	Full	266	50.2	LOS E	0.8	0.8	0.96	0.96	204.1	200.0	0.98
East: Railway Parade											
P2	Full	88	49.8	LOS E	0.3	0.3	0.95	0.95	203.7	200.0	0.98
North: Hawkesbury Road (N)											
P3	Full	61	49.8	LOS E	0.2	0.2	0.95	0.95	203.6	200.0	0.98
All Pedestrians		416	50.1	LOS E	0.8	0.8	0.95	0.95	203.9	200.0	0.98
Site: 13AM [HAW_ALE_23_13AM_DL]											

South: Hawkesbury Road (S)											
P1	Full	126	49.9	LOS E	0.4	0.4	0.95	0.95	203.8	200.0	0.98
East: Alexandra Avenue (E)											
P2	Full	240	50.2	LOS E	0.7	0.7	0.96	0.96	204.0	200.0	0.98
West: Alexandra Avenue (W)											
P4	Full	62	49.8	LOS E	0.2	0.2	0.95	0.95	203.6	200.0	0.98
All Pedestrians		428	50.0	LOS E	0.7	0.7	0.95	0.95	203.9	200.0	0.98

Level of Service (LOS) Method: SIDRA Pedestrian LOS Method (Based on Average Delay)
 Pedestrian movement LOS values are based on average delay per pedestrian movement.
 Intersection LOS value for Pedestrians is based on average delay for all pedestrian movements.

MOVEMENT SUMMARY

Site: 12AM [HAW_PRI_23_12AM_DL (Site Folder: Network 1)]

Output produced by SIDRA INTERSECTION Version: 9.1.4.221

Network: N101 [Network 1 - AM (Network Folder: Base Year_DL)]

TCS 1583 SS 44 7:30 AM - 8:30 AM

Site Category: Base Year

Signals - EQUISAT (Fixed-Time/SCATS) Coordinated Cycle Time = 111 seconds (Site User-Given Phase Times)

Vehicle Movement Performance															
Mov ID	Turn	Mov Class	Demand Flows		Arrival Flows		Deg. Satn	Aver. Delay	Level of Service	95% Back Of Queue		Prop. Que	Eff. Stop Rate	Aver. No. of Cycles	Aver. Speed
			[Total	HV]	[Total	HV]				[Veh.	Dist]				
			veh/h	%	veh/h	%	v/c	sec		veh	m				
South: Hawkesbury Road (S)															
2	T1	All MCs	595	2.7	595	2.7	0.302	13.5	LOS A	8.9	64.0	0.57	0.50	0.57	18.8
3	R2	All MCs	17	0.0	17	0.0	* 0.302	26.7	LOS B	8.4	59.9	0.59	0.51	0.59	23.7
Approach			612	2.6	612	2.6	0.302	13.9	LOS A	8.9	64.0	0.57	0.50	0.57	19.0
East: Priddle Street															
4	L2	All MCs	54	0.0	54	0.0	0.065	27.5	LOS B	2.1	14.4	0.75	0.69	0.75	12.3
6	R2	All MCs	34	3.1	34	3.1	0.056	30.2	LOS C	1.2	8.8	0.71	0.67	0.71	11.3
Approach			87	1.2	87	1.2	0.065	28.5	LOS C	2.1	14.4	0.74	0.68	0.74	11.9
North: Hawkesbury Road (N)															
7	L2	All MCs	12	0.0	12	0.0	0.015	29.0	LOS C	0.4	2.5	0.60	0.61	0.60	21.8
8	T1	All MCs	358	3.5	358	3.5	* 0.429	28.3	LOS B	13.1	94.2	0.73	0.63	0.73	17.9
Approach			369	3.4	369	3.4	0.429	28.3	LOS B	13.1	94.2	0.72	0.63	0.72	15.7
All Vehicles			1068	2.8	1068	2.8	0.429	20.1	LOS B	13.1	94.2	0.64	0.56	0.64	16.8

Site Level of Service (LOS) Method: Delay (RTA NSW). Site LOS Method is specified in the Network Data dialog (Override Site Data tab).

Vehicle movement LOS values are based on average delay per movement.

Intersection and Approach LOS values are based on average delay for all vehicle movements.

Delay Model: SIDRA Standard (Control Delay: Geometric Delay is included).

Queue Model: SIDRA queue estimation methods are used for Back of Queue and Queue at Start of Green.

Gap-Acceptance Capacity Formula: SIDRA Standard (Akçelik M3D).

HV (%) values are calculated for All Movement Classes of All Heavy Vehicle Model Designation.

Arrival Flows used in performance calculations are adjusted to include any Initial Queued Demand and Upstream Capacity Constraint effects.

* Critical Movement (Signal Timing)

Pedestrian Movement Performance											
Mov ID	Crossing	Dem. Flow ped/h	Aver. Delay sec	Level of Service	AVERAGE BACK OF QUEUE [Ped Dist]		Prop. Que	Eff. Stop Rate	Travel Time sec	Travel Dist. m	Aver. Speed m/sec
South: Hawkesbury Road (S)											
P1	Full	322	50.3	LOS E	1.0	1.0	0.96	0.96	204.2	200.0	0.98
East: Priddle Street											
P2	Full	68	49.8	LOS E	0.2	0.2	0.95	0.95	203.7	200.0	0.98
North: Hawkesbury Road (N)											
P3	Full	272	50.2	LOS E	0.8	0.8	0.96	0.96	204.1	200.0	0.98
All Pedestrians		662	50.2	LOS E	1.0	1.0	0.96	0.96	204.1	200.0	0.98

Level of Service (LOS) Method: SIDRA Pedestrian LOS Method (Based on Average Delay)
 Pedestrian movement LOS values are based on average delay per pedestrian movement.
 Intersection LOS value for Pedestrians is based on average delay for all pedestrian movements.

MOVEMENT SUMMARY

Site: 22AM [HAW_NOL_23_22AM_DL (Site Folder: Network 1)]

Output produced by SIDRA INTERSECTION Version: 9.1.4.221

Network: N101 [Network 1 - AM (Network Folder: Base Year_DL)]

Hawkesbury Road and Nolan Crescent
7:30 AM to 8:30 AM base year demand
Site Category: Base Year
Give-Way (Two-Way)

Vehicle Movement Performance															
Mov ID	Turn	Mov Class	Demand Flows [Total HV]		Arrival Flows [Total HV]		Deg. Satn	Aver. Delay	Level of Service	95% Back Of Queue [Veh. Dist]		Prop. Que	Eff. Stop Rate	Aver. No. of Cycles	Aver. Speed
			veh/h	%	veh/h	%	v/c	sec		veh	m				km/h
South: Hawkesbury Road (S)															
1	L2	All MCs	23	13.6	23	13.6	0.013	4.7	LOS A	0.0	0.0	0.00	0.53	0.00	42.2
2	T1	All MCs	766	2.1	766	2.1	0.400	0.1	LOS A	0.0	0.0	0.00	0.00	0.00	49.7
Approach			789	2.4	789	2.4	0.400	0.2	NA	0.0	0.0	0.00	0.02	0.00	49.1
North: Hawkesbury Road (N)															
8	T1	All MCs	449	3.5	449	3.5	0.233	0.0	LOS A	0.0	0.0	0.00	0.00	0.00	49.8
9	R2	All MCs	22	4.8	22	4.8	0.045	10.6	LOS A	0.2	1.1	0.65	0.82	0.65	36.1
Approach			472	3.6	472	3.6	0.233	0.5	NA	0.2	1.1	0.03	0.04	0.03	48.6
West: Nolan Crescent															
10	L2	All MCs	32	3.3	32	3.3	0.158	15.1	LOS B	0.5	3.4	0.78	0.89	0.78	28.9
12	R2	All MCs	8	12.5	8	12.5	0.158	25.9	LOS B	0.5	3.4	0.78	0.89	0.78	32.7
Approach			40	5.3	40	5.3	0.158	17.4	LOS B	0.5	3.4	0.78	0.89	0.78	29.9
All Vehicles			1301	2.9	1301	2.9	0.400	0.8	NA	0.5	3.4	0.03	0.05	0.03	47.5

Site Level of Service (LOS) Method: Delay (RTA NSW). Site LOS Method is specified in the Network Data dialog (Override Site Data tab).

Vehicle movement LOS values are based on average delay per movement.

Minor Road Approach LOS values are based on average delay for all vehicle movements.

NA (TWSC): Level of Service is not defined for major road approaches or the intersection as a whole for Two-Way Sign Control (HCM LOS rule).

Two-Way Sign Control Capacity Model: SIDRA Standard.

Delay Model: SIDRA Standard (Control Delay: Geometric Delay is included).

Queue Model: SIDRA queue estimation methods are used for Back of Queue and Queue at Start of Gap.

Gap-Acceptance Capacity Formula: SIDRA Standard (Akçelik M3D).

HV (%) values are calculated for All Movement Classes of All Heavy Vehicle Model Designation.

Arrival Flows used in performance calculations are adjusted to include any Initial Queued Demand and Upstream Capacity Constraint effects.

SIDRA INTERSECTION 9.1 | Copyright © 2000-2023 Akcelik and Associates Pty Ltd | sidrasolutions.com

Organisation: SCT CONSULTING PTY LTD | Licence: NETWORK / 1PC | Processed: Tuesday, 17 October 2023 1:22:08 PM

Project: S:\Projects\SCT_00410_Cumberland Westmead Sth Transport Study\3. Technical Work Area\1. Network Optimisation\SCT_00410_Cumberland Westmead Sth_SIDRA_v0.5.sip9

MOVEMENT SUMMARY

Site: 15AM [HAW_CHU_23_15AM_DL (Site Folder: Network 1)]

Output produced by SIDRA INTERSECTION Version: 9.1.4.221

Network: N101 [Network 1 - AM (Network Folder: Base Year_DL)]

Hawkesbury Road and Church Avenue
7:30 AM to 8:30 AM base year demand
Site Category: Base Year
Give-Way (Two-Way)

Vehicle Movement Performance															
Mov ID	Turn	Mov Class	Demand Flows [Total HV]	Flows %	Arrival Flows [Total HV]	Flows %	Deg. Satn	Aver. Delay	Level of Service	95% Back Of Queue [Veh. Dist]	Prop. Que	Eff. Stop Rate	Aver. No. of Cycles	Aver. Speed	
			veh/h	%	veh/h	%	v/c	sec		veh	m				km/h
South: Hawkesbury Road (S)															
1	L2	All MCs	7	0.0	7	0.0	0.313	4.6	LOS A	0.0	0.0	0.00	0.01	0.00	47.7
2	T1	All MCs	616	2.2	616	2.2	0.313	0.0	LOS A	0.0	0.0	0.00	0.01	0.00	49.6
Approach			623	2.2	623	2.2	0.313	0.1	NA	0.0	0.0	0.00	0.01	0.00	49.5
North: Hawkesbury Road (N)															
8	T1	All MCs	425	2.2	425	2.2	0.221	0.0	LOS A	0.0	0.0	0.00	0.00	0.00	49.8
9	R2	All MCs	37	11.4	37	11.4	0.032	6.9	LOS A	0.1	1.1	0.58	0.65	0.58	40.2
Approach			462	3.0	462	3.0	0.221	0.6	NA	0.1	1.1	0.05	0.05	0.05	45.8
West: Church Avenue															
10	L2	All MCs	108	3.9	108	3.9	0.299	11.1	LOS A	1.2	8.5	0.70	0.91	0.83	35.9
12	R2	All MCs	19	5.6	19	5.6	0.299	23.3	LOS B	1.2	8.5	0.70	0.91	0.83	35.9
Approach			127	4.1	127	4.1	0.299	12.9	LOS A	1.2	8.5	0.70	0.91	0.83	35.9
All Vehicles			1213	2.7	1213	2.7	0.313	1.6	NA	1.2	8.5	0.09	0.12	0.11	43.9

Site Level of Service (LOS) Method: Delay (RTA NSW). Site LOS Method is specified in the Network Data dialog (Override Site Data tab).

Vehicle movement LOS values are based on average delay per movement.

Minor Road Approach LOS values are based on average delay for all vehicle movements.

NA (TWSC): Level of Service is not defined for major road approaches or the intersection as a whole for Two-Way Sign Control (HCM LOS rule).

Two-Way Sign Control Capacity Model: SIDRA Standard.

Delay Model: SIDRA Standard (Control Delay: Geometric Delay is included).

Queue Model: SIDRA queue estimation methods are used for Back of Queue and Queue at Start of Gap.

Gap-Acceptance Capacity Formula: SIDRA Standard (Akçelik M3D).

HV (%) values are calculated for All Movement Classes of All Heavy Vehicle Model Designation.

Arrival Flows used in performance calculations are adjusted to include any Initial Queued Demand and Upstream Capacity Constraint effects.

SIDRA INTERSECTION 9.1 | Copyright © 2000-2023 Akcelik and Associates Pty Ltd | sidrasolutions.com

Organisation: SCT CONSULTING PTY LTD | Licence: NETWORK / 1PC | Processed: Tuesday, 17 October 2023 1:22:08 PM

Project: S:\Projects\SCT_00410_Cumberland Westmead Sth Transport Study\3. Technical Work Area\1. Network Optimisation\SCT_00410_Cumberland Westmead Sth_SIDRA_v0.5.sip9

MOVEMENT SUMMARY

Site: 20AM [HAW_AUS_23_20AM_DL (Site Folder: Network 1)]

Output produced by SIDRA INTERSECTION Version: 9.1.4.221

Network: N101 [Network 1 - AM (Network Folder: Base Year_DL)]

Hawkesbury Road and Church Avenue
7:30 AM to 8:30 AM base year demand
Site Category: Base Year
Give-Way (Two-Way)

Vehicle Movement Performance															
Mov ID	Turn	Mov Class	Demand Flows [Total HV]	Flows [Total HV]	Arrival Flows [Total HV]	Deg. Satn	Aver. Delay	Level of Service	95% Back Of Queue [Veh. Dist]	Prop. Que	Eff. Stop Rate	Aver. No. of Cycles	Aver. Speed		
			veh/h	%	veh/h	%	v/c	sec	veh	m			km/h		
South: Hawkesbury Road (S)															
1	L2	All MCs	58	0.0	58	0.0	0.354	4.6	LOS A	0.0	0.0	0.00	0.25	0.00	46.6
2	T1	All MCs	638	2.5	638	2.5	0.354	1.1	LOS A	0.0	0.0	0.00	0.25	0.00	39.9
Approach			696	2.3	696	2.3	0.354	1.4	NA	0.0	0.0	0.00	0.25	0.00	42.6
North: Hawkesbury Road (N)															
8	T1	All MCs	426	3.0	426	3.0	0.227	0.1	LOS A	0.1	0.7	0.04	0.05	0.04	39.1
9	R2	All MCs	11	0.0	11	0.0	0.227	6.2	LOS A	0.1	0.7	0.04	0.05	0.04	45.8
Approach			437	2.9	437	2.9	0.227	0.3	NA	0.1	0.7	0.04	0.05	0.04	39.8
West: Austral Avenue															
10	L2	All MCs	58	0.0	58	0.0	0.109	6.7	LOS A	0.4	2.6	0.52	0.75	0.52	42.9
12	R2	All MCs	44	2.4	44	2.4	0.109	7.4	LOS A	0.4	2.6	0.52	0.75	0.52	42.9
Approach			102	1.0	102	1.0	0.109	7.0	LOS A	0.4	2.6	0.52	0.75	0.52	42.9
All Vehicles			1235	2.4	1235	2.4	0.354	1.5	NA	0.4	2.6	0.06	0.22	0.06	41.8

Site Level of Service (LOS) Method: Delay (RTA NSW). Site LOS Method is specified in the Network Data dialog (Override Site Data tab).

Vehicle movement LOS values are based on average delay per movement.

Minor Road Approach LOS values are based on average delay for all vehicle movements.

NA (TWSC): Level of Service is not defined for major road approaches or the intersection as a whole for Two-Way Sign Control (HCM LOS rule).

Two-Way Sign Control Capacity Model: SIDRA Standard.

Delay Model: SIDRA Standard (Control Delay: Geometric Delay is included).

Queue Model: SIDRA queue estimation methods are used for Back of Queue and Queue at Start of Gap.

Gap-Acceptance Capacity Formula: SIDRA Standard (Akçelik M3D).

HV (%) values are calculated for All Movement Classes of All Heavy Vehicle Model Designation.

Arrival Flows used in performance calculations are adjusted to include any Initial Queued Demand and Upstream Capacity Constraint effects.

SIDRA INTERSECTION 9.1 | Copyright © 2000-2023 Akcelik and Associates Pty Ltd | sidrasolutions.com

Organisation: SCT CONSULTING PTY LTD | Licence: NETWORK / 1PC | Processed: Tuesday, 17 October 2023 1:22:08 PM

Project: S:\Projects\SCT_00410_Cumberland Westmead Sth Transport Study\3. Technical Work Area\1. Network Optimisation\SCT_00410_Cumberland Westmead Sth_SIDRA_v0.5.sip9

MOVEMENT SUMMARY

Site: 18AM [ALE_HAS_23_18AM (Site Folder: Network 1)]

Output produced by SIDRA INTERSECTION Version: 9.1.4.221

Network: N101 [Network 1 - AM (Network Folder: Base Year_DL)]

Alexandra Avenue and Hassall Street (8:00 to 9:00 AM)

TCS 3894 SS 44

Site Category: Base Year

Signals - EQUISAT (Fixed-Time/SCATS) Isolated Cycle Time = 66 seconds (Site User-Given Phase Times)

Vehicle Movement Performance															
Mov ID	Turn	Mov Class	Demand Flows [Total HV]		Arrival Flows [Total HV]		Deg. Satn	Aver. Delay	Level of Service	95% Back Of Queue [Veh. Dist]		Prop. Que	Eff. Stop Rate	Aver. No. of Cycles	Aver. Speed
			veh/h	%	veh/h	%	v/c	sec		veh	m				km/h
South: Hassall Street															
1	L2	All MCs	82	5.1	82	5.1	0.112	17.9	LOS B	1.6	12.0	0.65	0.71	0.65	13.7
3	R2	All MCs	159	2.0	159	2.0	* 0.382	28.8	LOS C	4.5	31.9	0.89	0.78	0.89	31.5
Approach			241	3.1	241	3.1	0.382	25.1	LOS B	4.5	31.9	0.81	0.76	0.81	28.8
East: Alexandra Avenue (E)															
4	L2	All MCs	59	5.4	59	5.4	0.045	8.3	LOS A	0.5	3.9	0.30	0.64	0.30	45.8
5	T1	All MCs	367	8.0	367	8.0	* 0.485	15.7	LOS B	8.8	66.1	0.79	0.68	0.79	39.8
Approach			426	7.7	426	7.7	0.485	14.7	LOS B	8.8	66.1	0.72	0.67	0.72	40.6
West: Alexandra Avenue (W)															
11	T1	All MCs	477	8.2	477	8.2	0.258	7.3	LOS A	4.4	32.8	0.55	0.47	0.55	49.9
12	R2	All MCs	33	9.7	33	9.7	* 0.258	19.9	LOS B	3.9	29.5	0.59	0.51	0.59	32.2
Approach			509	8.3	509	8.3	0.258	8.1	LOS A	4.4	32.8	0.55	0.47	0.55	49.3
All Vehicles			1177	7.0	1177	7.0	0.485	14.0	LOS A	8.8	66.1	0.66	0.60	0.66	41.6

Site Level of Service (LOS) Method: Delay (RTA NSW). Site LOS Method is specified in the Network Data dialog (Override Site Data tab).

Vehicle movement LOS values are based on average delay per movement.

Intersection and Approach LOS values are based on average delay for all vehicle movements.

Delay Model: SIDRA Standard (Control Delay: Geometric Delay is included).

Queue Model: SIDRA queue estimation methods are used for Back of Queue and Queue at Start of Green.

Gap-Acceptance Capacity Formula: SIDRA Standard (Akçelik M3D).

HV (%) values are calculated for All Movement Classes of All Heavy Vehicle Model Designation.

Arrival Flows used in performance calculations are adjusted to include any Initial Queued Demand and Upstream Capacity Constraint effects.

* Critical Movement (Signal Timing)

Pedestrian Movement Performance											
Mov ID	Crossing	Dem. Flow ped/h	Aver. Delay sec	Level of Service	AVERAGE BACK OF QUEUE [Ped Dist]		Prop. Que	Eff. Stop Rate	Travel Time sec	Travel Dist. m	Aver. Speed m/sec
South: Hassall Street											
P1	Full	27	27.3	LOS C	0.0	0.0	0.91	0.91	181.2	200.0	1.10
West: Alexandra Avenue (W)											
P4	Full	146	27.4	LOS C	0.3	0.3	0.91	0.91	181.3	200.0	1.10
All Pedestrians		174	27.4	LOS C	0.3	0.3	0.91	0.91	181.3	200.0	1.10

Level of Service (LOS) Method: SIDRA Pedestrian LOS Method (Based on Average Delay)
 Pedestrian movement LOS values are based on average delay per pedestrian movement.
 Intersection LOS value for Pedestrians is based on average delay for all pedestrian movements.

CCG MOVEMENT SUMMARY

Common Control Group: CCG1 [TCS 1571]

Output produced by SIDRA INTERSECTION Version: 9.1.4.221

Network: N101 [Network 1 - PM (Network Folder: Base Year_DL)]

EQUISAT (Fixed-Time/SCATS) Coordinated Cycle Time = 113 seconds (CCG User-Given Phase Times)

Vehicle Movement Performance (CCG)															
Mov ID	Turn	Mov Class	Demand Flows [Total HV]		Arrival Flows [Total HV]		Deg. Satn	Aver. Delay	Level of Service	Aver. Back Of Queue [Veh. Dist]		Prop. Que	Eff. Stop Rate	Aver. No. of Cycles	Aver. Speed
			veh/h	%	veh/h	%	v/c	sec		veh	m				km/h
Site: 14PM [HAW_RAI_23_14PM_DL]															
South: Hawkesbury Road (S)															
2	T1	All MCs	460	8.5	460	8.5	0.342	3.2	LOS A	4.9	34.9	0.18	0.35	0.18	34.3
3	R2	All MCs	203	0.5	203	0.5	0.342	31.4	LOS C	4.9	34.9	0.70	0.84	0.70	27.4
Approach			663	6.0	663	6.0	0.342	11.8	LOS A	4.9	34.9	0.34	0.50	0.34	29.8
East: Railway Parade															
4	L2	All MCs	239	1.7	239	1.7	0.468	26.0	LOS B	6.2	43.7	0.81	0.68	0.81	27.4
6	R2	All MCs	27	3.7	27	3.7	0.091	46.4	LOS D	0.8	5.6	0.88	0.69	0.88	23.7
Approach			266	1.9	266	1.9	0.468	28.0	LOS B	6.2	43.7	0.82	0.68	0.82	26.9
North: Hawkesbury Road (N)															
7	L2	All MCs	28	0.0	28	0.0	0.128	34.0	LOS C	1.4	13.7	0.74	0.64	0.74	27.0
8	T1	All MCs	612	6.5	612	6.5	0.931	67.3	LOS E	13.3	94.5	0.99	1.21	1.39	6.4
Approach			640	6.3	640	6.3	0.931	65.8	LOS E	13.3	94.5	0.98	1.19	1.37	7.5
All Vehicles			1569	5.4	1569	5.4	0.931	36.6	LOS C	13.3	94.5	0.68	0.81	0.84	17.9
Site: 13PM [HAW_ALE_23_13PM_DL]															
South: Hawkesbury Road (S)															
1	L2	All MCs	35	0.0	35	0.0	0.723	55.5	LOS D	7.4	51.7	1.00	0.88	1.07	25.6
2	T1	All MCs	362	0.8	362	0.8	*0.723	51.6	LOS D	7.4	51.7	1.00	0.89	1.08	10.4
Approach			397	0.8	397	0.8	0.723	52.0	LOS D	7.4	51.7	1.00	0.89	1.08	12.5
East: Alexandra Avenue (E)															
4	L2	All MCs	43	0.0	43	0.0	0.462	39.6	LOS C	7.5	53.2	0.85	0.74	0.85	13.4
5	T1	All MCs	205	0.0	205	0.0	0.462	32.8	LOS C	7.5	53.2	0.85	0.74	0.85	31.4
6	R2	All MCs	227	16.3	227	16.3	0.462	38.1	LOS C	7.5	53.2	0.85	0.78	0.85	12.7

Approach			475	7.8	475	7.8	0.462	36.0	LOS C	7.5	53.2	0.85	0.76	0.85	23.7
North: Hawkesbury Road (N)															
7	L2	All MCs	254	16.1	254	16.1	* 1.009	76.4	LOS F	7.6	55.0	0.98	1.14	1.46	2.9
8	T1	All MCs	554	0.5	554	0.5	1.009	49.4	LOS D	7.8	55.0	0.99	1.24	1.28	5.1
9	R2	All MCs	43	0.0	43	0.0	0.959	49.1	LOS D	7.8	55.0	0.99	1.25	1.24	27.5
Approach			851	5.2	851	5.2	1.009	57.5	LOS E	7.8	55.0	0.99	1.21	1.33	5.8
West: Alexandra Avenue (W)															
10	L2	All MCs	74	0.0	74	0.0	0.139	20.8	LOS B	1.1	7.9	0.75	0.72	0.75	34.5
11	T1	All MCs	257	0.0	257	0.0	* 0.675	46.4	LOS D	8.2	57.4	0.98	0.83	0.99	25.1
Approach			331	0.0	331	0.0	0.675	40.7	LOS C	8.2	57.4	0.93	0.81	0.94	26.8
All Vehicles			2054	4.1	2054	4.1	1.009	48.7	LOS D	8.2	57.4	0.95	0.98	1.11	15.3

Site Level of Service (LOS) Method: Delay (RTA NSW). Site LOS Method is specified in the Network Data dialog (Override Site Data tab).

Vehicle movement LOS values are based on average delay per movement.

Intersection and Approach LOS values are based on average delay for all vehicle movements.

Delay Model: SIDRA Standard (Control Delay: Geometric Delay is included).

Gap-Acceptance Capacity Formula: SIDRA Standard (Akçelik M3D).

HV (%) values are calculated for All Movement Classes of All Heavy Vehicle Model Designation.

Arrival Flows used in performance calculations are adjusted to include any Initial Queued Demand and Upstream Capacity Constraint effects.

* Critical Movement (Signal Timing)

Pedestrian Movement Performance (CCG)											
Mov ID	Crossing	Dem. Flow ped/h	Aver. Delay sec	Level of Service	AVERAGE BACK OF QUEUE [Ped Dist]		Prop. Que	Eff. Stop Rate	Travel Time sec	Travel Dist. m	Aver. Speed m/sec
Site: 14PM [HAW_RAI_23_14PM_DL]											
South: Hawkesbury Road (S)											
P1	Full	146	51.0	LOS E	0.4	0.4	0.95	0.95	204.8	200.0	0.98
East: Railway Parade											
P2	Full	89	50.8	LOS E	0.3	0.3	0.95	0.95	204.7	200.0	0.98
North: Hawkesbury Road (N)											
P3	Full	56	50.8	LOS E	0.2	0.2	0.95	0.95	204.6	200.0	0.98
All Pedestrians		292	50.9	LOS E	0.4	0.4	0.95	0.95	204.7	200.0	0.98
Site: 13PM [HAW_ALE_23_13PM_DL]											

South: Hawkesbury Road (S)											
P1	Full	80	50.8	LOS E	0.2	0.2	0.95	0.95	204.7	200.0	0.98
East: Alexandra Avenue (E)											
P2	Full	135	50.9	LOS E	0.4	0.4	0.95	0.95	204.8	200.0	0.98
West: Alexandra Avenue (W)											
P4	Full	40	50.7	LOS E	0.1	0.1	0.95	0.95	204.6	200.0	0.98
All Pedestrians		255	50.9	LOS E	0.4	0.4	0.95	0.95	204.7	200.0	0.98

Level of Service (LOS) Method: SIDRA Pedestrian LOS Method (Based on Average Delay)
 Pedestrian movement LOS values are based on average delay per pedestrian movement.
 Intersection LOS value for Pedestrians is based on average delay for all pedestrian movements.

MOVEMENT SUMMARY

Site: 12PM [HAW_PRI_23_12PM_DL (Site Folder: Network 1)]

Output produced by SIDRA INTERSECTION Version: 9.1.4.221

Network: N101 [Network 1 - PM (Network Folder: Base Year_DL)]

TCS 1583 SS 44

5:00 PM to 6:00 PM Base year demand

Site Category: Base Year

Signals - EQUISAT (Fixed-Time/SCATS) Isolated Cycle Time = 66 seconds (Site User-Given Phase Times)

Vehicle Movement Performance															
Mov ID	Turn	Mov Class	Demand Flows [Total HV]		Arrival Flows [Total HV]		Deg. Satn	Aver. Delay	Level of Service	Aver. Back Of Queue [Veh. Dist]		Prop. Que	Eff. Stop Rate	Aver. No. of Cycles	Aver. Speed
			veh/h	%	veh/h	%	v/c	sec		veh	m				km/h
South: Hawkesbury Road (S)															
2	T1	All MCs	458	0.9	458	0.9	0.238	4.9	LOS A	2.1	15.0	0.47	0.40	0.47	28.5
3	R2	All MCs	12	0.0	12	0.0	* 0.238	121.7	LOS F	2.1	14.7	0.78	0.64	0.78	23.7
Approach			469	0.9	469	0.9	0.238	7.8	LOS A	2.1	15.0	0.48	0.40	0.48	28.2
East: Priddle Street															
4	L2	All MCs	33	0.0	33	0.0	0.072	25.6	LOS B	0.5	3.5	0.80	0.69	0.80	13.7
6	R2	All MCs	23	0.0	23	0.0	* 0.069	29.3	LOS C	0.4	2.7	0.86	0.69	0.86	12.3
Approach			56	0.0	56	0.0	0.072	27.2	LOS B	0.5	3.5	0.82	0.69	0.82	13.0
North: Hawkesbury Road (N)															
7	L2	All MCs	12	0.0	12	0.0	0.010	11.9	LOS A	0.1	0.6	0.41	0.60	0.41	32.9
8	T1	All MCs	653	0.5	652	0.5	* 0.567	10.4	LOS A	7.7	54.3	0.65	0.58	0.65	31.5
Approach			664	0.5	663	0.5	0.567	10.4	LOS A	7.7	54.3	0.64	0.58	0.64	29.2
All Vehicles			1189	0.6	1189	0.6	0.567	10.1	LOS A	7.7	54.3	0.59	0.52	0.59	27.6

Site Level of Service (LOS) Method: Delay (RTA NSW). Site LOS Method is specified in the Network Data dialog (Override Site Data tab).

Vehicle movement LOS values are based on average delay per movement.

Intersection and Approach LOS values are based on average delay for all vehicle movements.

Delay Model: SIDRA Standard (Control Delay: Geometric Delay is included).

Queue Model: SIDRA queue estimation methods are used for Back of Queue and Queue at Start of Green.

Gap-Acceptance Capacity Formula: SIDRA Standard (Akçelik M3D).

HV (%) values are calculated for All Movement Classes of All Heavy Vehicle Model Designation.

Arrival Flows used in performance calculations are adjusted to include any Initial Queued Demand and Upstream Capacity Constraint effects.

* Critical Movement (Signal Timing)

Pedestrian Movement Performance											
Mov ID	Crossing	Dem. Flow ped/h	Aver. Delay sec	Level of Service	AVERAGE BACK OF QUEUE [Ped Dist]		Prop. Que	Eff. Stop Rate	Travel Time sec	Travel Dist. m	Aver. Speed m/sec
South: Hawkesbury Road (S)											
P1	Full	40	27.3	LOS C	0.1	0.1	0.91	0.91	181.2	200.0	1.10
East: Priddle Street											
P2	Full	23	27.3	LOS C	0.0	0.0	0.91	0.91	181.1	200.0	1.10
North: Hawkesbury Road (N)											
P3	Full	32	27.3	LOS C	0.1	0.1	0.91	0.91	181.2	200.0	1.10
All Pedestrians		95	27.3	LOS C	0.1	0.1	0.91	0.91	181.2	200.0	1.10

Level of Service (LOS) Method: SIDRA Pedestrian LOS Method (Based on Average Delay)
 Pedestrian movement LOS values are based on average delay per pedestrian movement.
 Intersection LOS value for Pedestrians is based on average delay for all pedestrian movements.

MOVEMENT SUMMARY

Site: 22PM [HAW_NOL_23_22PM_DL (Site Folder: Network 1)]

Output produced by SIDRA INTERSECTION Version: 9.1.4.221

Network: N101 [Network 1 - PM (Network Folder: Base Year_DL)]

Hawkesbury Road and Nolan Crescent
 5:00 PM to 6:00 PM Base year demand
 Site Category: Base Year
 Give-Way (Two-Way)

Vehicle Movement Performance															
Mov ID	Turn	Mov Class	Demand Flows [Total HV]	Flows %	Arrival Flows [Total HV]	Flows %	Deg. Satn	Aver. Delay	Level of Service	Aver. Back Of Queue [Veh. Dist]	Prop. Que	Eff. Stop Rate	Aver. No. of Cycles	Aver. Speed	
			veh/h	%	veh/h	%	v/c	sec		veh	m			km/h	
South: Hawkesbury Road (S)															
1	L2	All MCs	28	0.0	28	0.0	0.015	4.6	LOS A	0.0	0.0	0.00	0.53	0.00	42.6
2	T1	All MCs	420	0.3	420	0.3	0.217	0.0	LOS A	0.0	0.0	0.00	0.00	0.00	49.9
Approach			448	0.2	448	0.2	0.217	0.3	NA	0.0	0.0	0.00	0.03	0.00	48.6
North: Hawkesbury Road (N)															
8	T1	All MCs	706	1.0	706	1.0	0.361	0.0	LOS A	0.0	0.0	0.00	0.00	0.00	49.8
9	R2	All MCs	32	0.0	32	0.0	0.035	6.6	LOS A	0.1	0.4	0.46	0.64	0.46	39.5
Approach			738	1.0	738	1.0	0.361	0.3	NA	0.1	0.4	0.02	0.03	0.02	49.1
West: Nolan Crescent															
10	L2	All MCs	6	0.0	6	0.0	0.031	6.0	LOS A	0.0	0.3	0.60	0.72	0.60	35.1
12	R2	All MCs	8	0.0	8	0.0	0.031	13.3	LOS A	0.0	0.3	0.60	0.72	0.60	37.7
Approach			15	0.0	15	0.0	0.031	10.1	LOS A	0.0	0.3	0.60	0.72	0.60	36.8
All Vehicles			1201	0.7	1201	0.7	0.361	0.4	NA	0.1	0.4	0.02	0.04	0.02	48.6

Site Level of Service (LOS) Method: Delay (RTA NSW). Site LOS Method is specified in the Network Data dialog (Override Site Data tab).

Vehicle movement LOS values are based on average delay per movement.

Minor Road Approach LOS values are based on average delay for all vehicle movements.

NA (TWSC): Level of Service is not defined for major road approaches or the intersection as a whole for Two-Way Sign Control (HCM LOS rule).

Two-Way Sign Control Capacity Model: SIDRA Standard.

Delay Model: SIDRA Standard (Control Delay: Geometric Delay is included).

Queue Model: SIDRA queue estimation methods are used for Back of Queue and Queue at Start of Gap.

Gap-Acceptance Capacity Formula: SIDRA Standard (Akçelik M3D).

HV (%) values are calculated for All Movement Classes of All Heavy Vehicle Model Designation.

Arrival Flows used in performance calculations are adjusted to include any Initial Queued Demand and Upstream Capacity Constraint effects.

SIDRA INTERSECTION 9.1 | Copyright © 2000-2023 Akcelik and Associates Pty Ltd | sidrasolutions.com

Organisation: SCT CONSULTING PTY LTD | Licence: NETWORK / 1PC | Processed: Tuesday, 17 October 2023 1:22:14 PM

Project: S:\Projects\SCT_00410_Cumberland Westmead Sth Transport Study\3. Technical Work Area\1. Network Optimisation\SCT_00410_Cumberland Westmead Sth_SIDRA_v0.5.sip9

MOVEMENT SUMMARY

Site: 15PM [HAW_CHU_23_15PM_DL (Site Folder: Network 1)]

Output produced by SIDRA INTERSECTION Version: 9.1.4.221

Network: N101 [Network 1 - PM (Network Folder: Base Year_DL)]

Hawkesbury Road and Church Avenue
 5:00 PM to 6:00 PM Base year demand
 Site Category: Base Year
 Give-Way (Two-Way)

Vehicle Movement Performance															
Mov ID	Turn	Mov Class	Demand Flows [Total HV]	Flows %	Arrival Flows [Total HV]	Flows %	Deg. Satn	Aver. Delay	Level of Service	Aver. Back Of Queue [Veh. Dist]	Prop. Que	Eff. Stop Rate	Aver. No. of Cycles	Aver. Speed	
			veh/h	%	veh/h	%	v/c	sec		veh	m			km/h	
South: Hawkesbury Road (S)															
1	L2	All MCs	19	0.0	19	0.0	0.224	4.6	LOS A	0.0	0.0	0.00	0.02	0.00	47.6
2	T1	All MCs	432	0.5	432	0.5	0.224	0.0	LOS A	0.0	0.0	0.00	0.02	0.00	49.0
Approach			451	0.5	451	0.5	0.224	0.2	NA	0.0	0.0	0.00	0.02	0.00	48.8
North: Hawkesbury Road (N)															
8	T1	All MCs	676	0.6	676	0.6	0.348	0.0	LOS A	0.0	0.0	0.00	0.00	0.00	49.8
9	R2	All MCs	67	1.6	67	1.6	0.043	5.8	LOS A	0.1	0.6	0.48	0.59	0.48	40.8
Approach			743	0.7	743	0.7	0.348	0.5	NA	0.1	0.6	0.04	0.05	0.04	45.8
West: Church Avenue															
10	L2	All MCs	84	5.0	84	5.0	0.156	6.0	LOS A	0.2	1.7	0.57	0.71	0.57	40.4
12	R2	All MCs	43	0.0	43	0.0	0.156	11.5	LOS A	0.2	1.7	0.57	0.71	0.57	40.4
Approach			127	3.3	127	3.3	0.156	7.8	LOS A	0.2	1.7	0.57	0.71	0.57	40.4
All Vehicles			1321	0.9	1321	0.9	0.348	1.1	NA	0.2	1.7	0.08	0.11	0.08	45.2

Site Level of Service (LOS) Method: Delay (RTA NSW). Site LOS Method is specified in the Network Data dialog (Override Site Data tab).

Vehicle movement LOS values are based on average delay per movement.

Minor Road Approach LOS values are based on average delay for all vehicle movements.

NA (TWSC): Level of Service is not defined for major road approaches or the intersection as a whole for Two-Way Sign Control (HCM LOS rule).

Two-Way Sign Control Capacity Model: SIDRA Standard.

Delay Model: SIDRA Standard (Control Delay: Geometric Delay is included).

Queue Model: SIDRA queue estimation methods are used for Back of Queue and Queue at Start of Gap.

Gap-Acceptance Capacity Formula: SIDRA Standard (Akçelik M3D).

HV (%) values are calculated for All Movement Classes of All Heavy Vehicle Model Designation.

Arrival Flows used in performance calculations are adjusted to include any Initial Queued Demand and Upstream Capacity Constraint effects.

SIDRA INTERSECTION 9.1 | Copyright © 2000-2023 Akcelik and Associates Pty Ltd | sidrasolutions.com

Organisation: SCT CONSULTING PTY LTD | Licence: NETWORK / 1PC | Processed: Tuesday, 17 October 2023 1:22:14 PM

Project: S:\Projects\SCT_00410_Cumberland Westmead Sth Transport Study\3. Technical Work Area\1. Network Optimisation\SCT_00410_Cumberland Westmead Sth_SIDRA_v0.5.sip9

MOVEMENT SUMMARY

Site: 20PM [HAW_AUS_23_20PM_DL (Site Folder: Network 1)]

Output produced by SIDRA INTERSECTION Version: 9.1.4.221

Network: N101 [Network 1 - PM (Network Folder: Base Year_DL)]

Hawkesbury Road and Church Avenue
5:00 PM to 6:00 PM Base year demand
Site Category: Base Year
Give-Way (Two-Way)

Vehicle Movement Performance															
Mov ID	Turn	Mov Class	Demand Flows [Total HV]	Arrival Flows [Total HV]	Deg. Satn	Aver. Delay	Level of Service	Aver. Back Of Queue [Veh. Dist]	Prop. Que	Eff. Stop Rate	Aver. No. of Cycles	Aver. Speed			
			veh/h	%	veh/h	%	v/c	sec		veh	m				km/h
South: Hawkesbury Road (S)															
1	L2	All MCs	46	0.0	46	0.0	0.254	4.6	LOS A	0.0	0.0	0.00	0.25	0.00	46.7
2	T1	All MCs	457	0.7	457	0.7	0.254	1.1	LOS A	0.0	0.0	0.00	0.25	0.00	39.8
Approach			503	0.6	503	0.6	0.254	1.4	NA	0.0	0.0	0.00	0.25	0.00	42.7
North: Hawkesbury Road (N)															
8	T1	All MCs	677	0.8	676	0.8	0.372	0.2	LOS A	0.2	1.1	0.08	0.10	0.08	38.3
9	R2	All MCs	45	0.0	45	0.0	0.372	5.4	LOS A	0.2	1.1	0.08	0.10	0.08	45.6
Approach			722	0.7	721	0.7	0.372	0.5	NA	0.2	1.1	0.08	0.10	0.08	40.0
West: Austral Avenue															
10	L2	All MCs	45	2.3	45	2.3	0.179	7.8	LOS A	0.2	1.6	0.56	0.80	0.56	41.5
12	R2	All MCs	62	0.0	62	0.0	0.179	9.3	LOS A	0.2	1.6	0.56	0.80	0.56	41.5
Approach			107	1.0	107	1.0	0.179	8.7	LOS A	0.2	1.6	0.56	0.80	0.56	41.5
All Vehicles			1333	0.7	1332	0.7	0.372	1.5	NA	0.2	1.6	0.09	0.21	0.09	41.0

Site Level of Service (LOS) Method: Delay (RTA NSW). Site LOS Method is specified in the Network Data dialog (Override Site Data tab).

Vehicle movement LOS values are based on average delay per movement.

Minor Road Approach LOS values are based on average delay for all vehicle movements.

NA (TWSC): Level of Service is not defined for major road approaches or the intersection as a whole for Two-Way Sign Control (HCM LOS rule).

Two-Way Sign Control Capacity Model: SIDRA Standard.

Delay Model: SIDRA Standard (Control Delay: Geometric Delay is included).

Queue Model: SIDRA queue estimation methods are used for Back of Queue and Queue at Start of Gap.

Gap-Acceptance Capacity Formula: SIDRA Standard (Akçelik M3D).

HV (%) values are calculated for All Movement Classes of All Heavy Vehicle Model Designation.

Arrival Flows used in performance calculations are adjusted to include any Initial Queued Demand and Upstream Capacity Constraint effects.

SIDRA INTERSECTION 9.1 | Copyright © 2000-2023 Akcelik and Associates Pty Ltd | sidrasolutions.com

Organisation: SCT CONSULTING PTY LTD | Licence: NETWORK / 1PC | Processed: Tuesday, 17 October 2023 1:22:14 PM

Project: S:\Projects\SCT_00410_Cumberland Westmead Sth Transport Study\3. Technical Work Area\1. Network Optimisation\SCT_00410_Cumberland Westmead Sth_SIDRA_v0.5.sip9

MOVEMENT SUMMARY

Site: 18PM [ALE_HAS_23_18PM (Site Folder: Network 1)]

Output produced by SIDRA INTERSECTION Version: 9.1.4.221

Network: N101 [Network 1 - PM (Network Folder: Base Year_DL)]

Alexandra Avenue and Hassall Street (5:00 to 6:00 PM)

TCS 3894 SS 44

Site Category: Base Year

Signals - EQUISAT (Fixed-Time/SCATS) Isolated Cycle Time = 78 seconds (Site User-Given Phase Times)

Vehicle Movement Performance															
Mov ID	Turn	Mov Class	Demand Flows [Total HV]		Arrival Flows [Total HV]		Deg. Satn	Aver. Delay	Level of Service	Aver. Back Of Queue [Veh. Dist]		Prop. Que	Eff. Stop Rate	Aver. No. of Cycles	Aver. Speed
			veh/h	%	veh/h	%	v/c	sec		veh	m				km/h
South: Hassall Street															
1	L2	All MCs	36	8.8	36	8.8	0.053	21.0	LOS B	0.5	3.9	0.65	0.69	0.65	12.0
3	R2	All MCs	69	0.0	69	0.0	* 0.208	35.0	LOS C	1.4	9.9	0.89	0.75	0.89	28.9
Approach			105	3.0	105	3.0	0.208	30.2	LOS C	1.4	9.9	0.81	0.73	0.81	26.3
East: Alexandra Avenue (E)															
4	L2	All MCs	294	1.1	294	1.1	0.218	9.1	LOS A	2.2	15.2	0.34	0.67	0.34	45.0
5	T1	All MCs	464	7.7	464	7.7	* 0.527	15.5	LOS B	7.6	56.8	0.75	0.66	0.75	39.9
Approach			758	5.1	758	5.1	0.527	13.0	LOS A	7.6	56.8	0.59	0.66	0.59	41.9
West: Alexandra Avenue (W)															
11	T1	All MCs	477	9.1	475	9.1	0.254	5.6	LOS A	2.8	21.4	0.47	0.42	0.47	51.0
12	R2	All MCs	60	0.0	60	0.0	* 0.254	21.1	LOS B	2.6	18.9	0.57	0.54	0.57	31.0
Approach			537	8.0	535	8.0	0.254	7.3	LOS A	2.8	21.4	0.48	0.43	0.48	49.6
All Vehicles			1400	6.1	1398	6.1	0.527	12.2	LOS A	7.6	56.8	0.56	0.58	0.56	43.3

Site Level of Service (LOS) Method: Delay (RTA NSW). Site LOS Method is specified in the Network Data dialog (Override Site Data tab).

Vehicle movement LOS values are based on average delay per movement.

Intersection and Approach LOS values are based on average delay for all vehicle movements.

Delay Model: SIDRA Standard (Control Delay: Geometric Delay is included).

Queue Model: SIDRA queue estimation methods are used for Back of Queue and Queue at Start of Green.

Gap-Acceptance Capacity Formula: SIDRA Standard (Akçelik M3D).

HV (%) values are calculated for All Movement Classes of All Heavy Vehicle Model Designation.

Arrival Flows used in performance calculations are adjusted to include any Initial Queued Demand and Upstream Capacity Constraint effects.

* Critical Movement (Signal Timing)

Pedestrian Movement Performance											
Mov ID	Crossing	Dem. Flow ped/h	Aver. Delay sec	Level of Service	AVERAGE BACK OF QUEUE [Ped Dist]		Prop. Que	Eff. Stop Rate	Travel Time sec	Travel Dist. m	Aver. Speed m/sec
South: Hassall Street											
P1	Full	24	33.3	LOS D	0.0	0.0	0.92	0.92	187.1	200.0	1.07
West: Alexandra Avenue (W)											
P4	Full	146	33.4	LOS D	0.3	0.3	0.93	0.93	187.3	200.0	1.07
All Pedestrians		171	33.4	LOS D	0.3	0.3	0.93	0.93	187.3	200.0	1.07

Level of Service (LOS) Method: SIDRA Pedestrian LOS Method (Based on Average Delay)
 Pedestrian movement LOS values are based on average delay per pedestrian movement.
 Intersection LOS value for Pedestrians is based on average delay for all pedestrian movements.

MOVEMENT SUMMARY

Site: 21AM [BRI_MON_23_21AM_DL (Site Folder: Network 2)]

Output produced by SIDRA INTERSECTION Version: 9.1.4.221

Network: N101 [Network 2 - AM (Network Folder: Base Year_DL)]

Bridge Road and Entry to Monarco (8:00 to 9:00 AM)

Site Category: Base Year

Roundabout

Vehicle Movement Performance															
Mov ID	Turn	Mov Class	Demand Flows		Arrival Flows		Deg. Satn	Aver. Delay	Level of Service	Aver. Back Of Queue		Prop. Que	Eff. Stop Rate	Aver. No. of Cycles	Aver. Speed
			[Total	HV]	[Total	HV]				[Veh.	Dist]				
			veh/h	%	veh/h	%	v/c	sec		veh	m				km/h
South: Bridge Road (S)															
2	T1	All MCs	456	3.9	456	3.9	0.361	4.1	LOS A	0.9	6.3	0.19	0.46	0.19	41.5
3	R2	All MCs	35	0.0	35	0.0	0.361	6.7	LOS A	0.9	6.3	0.19	0.46	0.19	37.1
3u	U	All MCs	13	0.0	13	0.0	0.361	8.0	LOS A	0.9	6.3	0.19	0.46	0.19	33.1
Approach			503	3.6	503	3.6	0.361	4.4	LOS A	0.9	6.3	0.19	0.46	0.19	41.2
East: Monarco Entry															
4	L2	All MCs	95	1.1	95	1.1	0.156	7.2	LOS A	0.3	2.2	0.54	0.67	0.54	30.5
6	R2	All MCs	39	0.0	39	0.0	0.156	9.2	LOS A	0.3	2.2	0.54	0.67	0.54	38.6
6u	U	All MCs	1	0.0	1	0.0	0.156	10.5	LOS A	0.3	2.2	0.54	0.67	0.54	34.9
Approach			135	0.8	135	0.8	0.156	7.8	LOS A	0.3	2.2	0.54	0.67	0.54	34.4
North: Bridge Road (N)															
7	L2	All MCs	16	0.0	16	0.0	0.353	4.9	LOS A	0.5	3.9	0.12	0.45	0.12	41.7
8	T1	All MCs	476	2.9	476	2.9	0.353	4.0	LOS A	0.5	3.9	0.12	0.45	0.12	41.9
9u	U	All MCs	4	0.0	4	0.0	0.353	7.9	LOS A	0.5	3.9	0.12	0.45	0.12	43.5
Approach			496	2.8	496	2.8	0.353	4.1	LOS A	0.5	3.9	0.12	0.45	0.12	41.9
All Vehicles			1134	2.9	1134	2.9	0.361	4.6	LOS A	0.9	6.3	0.20	0.48	0.20	40.8

Site Level of Service (LOS) Method: Delay (RTA NSW). Site LOS Method is specified in the Network Data dialog (Override Site Data tab).

Vehicle movement LOS values are based on average delay per movement.

Intersection and Approach LOS values are based on average delay for all vehicle movements.

Roundabout Capacity Model: SIDRA Standard.

Delay Model: SIDRA Standard (Control Delay: Geometric Delay is included).

Queue Model: SIDRA queue estimation methods are used for Back of Queue and Queue at Start of Gap.

Gap-Acceptance Capacity Formula: SIDRA Standard (Akçelik M3D).

HV (%) values are calculated for All Movement Classes of All Heavy Vehicle Model Designation.

Arrival Flows used in performance calculations are adjusted to include any Initial Queued Demand and Upstream Capacity Constraint effects.

SIDRA INTERSECTION 9.1 | Copyright © 2000-2023 Akcelik and Associates Pty Ltd | sidrasolutions.com

Organisation: SCT CONSULTING PTY LTD | Licence: NETWORK / 1PC | Processed: Tuesday, 17 October 2023 1:27:45 PM

Project: S:\Projects\SCT_00410_Cumberland Westmead Sth Transport Study\3. Technical Work Area\1. Network Optimisation\SCT_00410_Cumberland Westmead Sth_SIDRA_v0.5.sip9

MOVEMENT SUMMARY

Site: 24AM [BRI_ALE_23_24AM_DL (Site Folder: Network 2)]

Output produced by SIDRA INTERSECTION Version: 9.1.4.221

Network: N101 [Network 2 - AM (Network Folder: Base Year_DL)]

Bridge Road and Alexandra Avenue (8:00 to 9:00 AM)

Site Category: Base Year

Roundabout

Vehicle Movement Performance															
Mov ID	Turn	Mov Class	Demand Flows		Arrival Flows		Deg. Satn	Aver. Delay	Level of Service	Aver. Back Of Queue		Prop. Que	Eff. Stop Rate	Aver. No. of Cycles	Aver. Speed
			[Total	HV]	[Total	HV]				[Veh.	Dist]				
			veh/h	%	veh/h	%	v/c	sec		veh	m				km/h
South: Bridge Road (S)															
2	T1	All MCs	547	3.5	547	3.5	0.637	4.2	LOS A	1.9	13.5	0.27	0.54	0.27	25.7
3	R2	All MCs	284	0.4	284	0.4	0.637	7.2	LOS A	1.9	13.5	0.27	0.54	0.27	43.3
3u	U	All MCs	6	0.0	6	0.0	0.637	8.5	LOS A	1.9	13.5	0.27	0.54	0.27	25.7
Approach			838	2.4	838	2.4	0.637	5.2	LOS A	1.9	13.5	0.27	0.54	0.27	38.4
East: Alexandra Avenue															
4	L2	All MCs	120	1.8	120	1.8	0.268	6.6	LOS A	0.6	4.0	0.60	0.70	0.60	42.9
6	R2	All MCs	104	0.0	104	0.0	0.268	8.8	LOS A	0.6	4.0	0.60	0.70	0.60	42.9
6u	U	All MCs	1	0.0	1	0.0	0.268	10.1	LOS A	0.6	4.0	0.60	0.70	0.60	45.1
Approach			225	0.9	225	0.9	0.268	7.6	LOS A	0.6	4.0	0.60	0.70	0.60	43.0
North: Bridge Road (N)															
7	L2	All MCs	187	0.6	187	0.6	0.708	8.2	LOS A	3.7	26.1	0.82	0.61	0.87	42.3
8	T1	All MCs	562	2.4	562	2.4	0.708	7.9	LOS A	3.7	26.1	0.82	0.61	0.87	27.3
9u	U	All MCs	1	0.0	1	0.0	0.708	12.1	LOS A	3.7	26.1	0.82	0.61	0.87	27.3
Approach			751	2.0	751	2.0	0.708	8.0	LOS A	3.7	26.1	0.82	0.61	0.87	35.6
All Vehicles			1814	2.0	1814	2.0	0.708	6.7	LOS A	3.7	26.1	0.54	0.59	0.56	38.3

Site Level of Service (LOS) Method: Delay (RTA NSW). Site LOS Method is specified in the Network Data dialog (Override Site Data tab).

Vehicle movement LOS values are based on average delay per movement.

Intersection and Approach LOS values are based on average delay for all vehicle movements.

Roundabout Capacity Model: SIDRA Standard.

Delay Model: SIDRA Standard (Control Delay: Geometric Delay is included).

Queue Model: SIDRA queue estimation methods are used for Back of Queue and Queue at Start of Gap.

Gap-Acceptance Capacity Formula: SIDRA Standard (Akçelik M3D).

HV (%) values are calculated for All Movement Classes of All Heavy Vehicle Model Designation.

Arrival Flows used in performance calculations are adjusted to include any Initial Queued Demand and Upstream Capacity Constraint effects.

SIDRA INTERSECTION 9.1 | Copyright © 2000-2023 Akcelik and Associates Pty Ltd | sidrasolutions.com

Organisation: SCT CONSULTING PTY LTD | Licence: NETWORK / 1PC | Processed: Tuesday, 17 October 2023 1:27:45 PM

Project: S:\Projects\SCT_00410_Cumberland Westmead Sth Transport Study\3. Technical Work Area\1. Network Optimisation\SCT_00410_Cumberland Westmead Sth_SIDRA_v0.5.sip9

MOVEMENT SUMMARY

Site: 2AM [BRI_GRA_23_2AM_DL (Site Folder: Network 2)]

Output produced by SIDRA INTERSECTION Version: 9.1.4.221

Network: N101 [Network 2 - AM (Network Folder: Base Year_DL)]

Bridge Road and Grand Avenue (8:00 to 9:00 AM)

TCS 1570

Site Category: Base Year

Signals - EQUISAT (Fixed-Time/SCATS) Coordinated Cycle Time = 51 seconds (Site User-Given Phase Times)

Vehicle Movement Performance															
Mov ID	Turn	Mov Class	Demand Flows [Total HV]		Arrival Flows [Total HV]		Deg. Satn	Aver. Delay	Level of Service	Aver. Back Of Queue [Veh. Dist]		Prop. Que	Eff. Stop Rate	Aver. No. of Cycles	Aver. Speed
			veh/h	%	veh/h	%	v/c	sec		veh	m				km/h
South: Bridge Road (S)															
1	L2	All MCs	53	2.0	53	2.0	0.067	19.5	LOS B	0.8	5.6	1.00	0.59	1.00	31.8
2	T1	All MCs	464	3.2	464	3.2	*0.563	20.7	LOS B	7.2	51.6	1.00	0.75	1.00	7.8
Approach			517	3.1	517	3.1	0.563	20.6	LOS B	7.2	51.6	1.00	0.73	1.00	12.9
East: Grand Avenue															
4	L2	All MCs	20	0.0	20	0.0	0.159	25.0	LOS B	0.7	5.2	0.88	0.69	0.88	33.1
5	T1	All MCs	33	0.0	33	0.0	0.159	20.4	LOS B	0.7	5.2	0.88	0.69	0.88	38.9
6	R2	All MCs	1	100.0	1	100.0	0.159	26.3	LOS B	0.7	5.2	0.88	0.69	0.88	33.2
Approach			54	2.0	54	2.0	0.159	22.3	LOS B	0.7	5.2	0.88	0.69	0.88	37.1
North: Bridge Road (N)															
7	L2	All MCs	22	4.8	22	4.8	0.178	12.3	LOS A	1.3	9.5	0.42	0.39	0.42	44.2
8	T1	All MCs	349	2.1	349	2.1	0.698	9.4	LOS A	4.9	35.2	0.65	0.59	0.69	23.0
9	R2	All MCs	204	4.6	204	4.6	*0.698	27.6	LOS B	4.9	35.2	0.94	0.87	1.03	33.6
Approach			576	3.1	576	3.1	0.698	16.0	LOS B	4.9	35.2	0.74	0.68	0.80	27.7
West: Veron Street															
10	L2	All MCs	293	2.9	293	2.9	0.468	18.8	LOS B	3.6	25.6	0.82	0.79	0.82	32.3
11	T1	All MCs	43	7.3	43	7.3	*0.355	20.6	LOS B	1.5	11.0	0.92	0.75	0.92	38.1
12	R2	All MCs	64	0.0	64	0.0	0.355	26.1	LOS B	1.5	11.0	0.92	0.75	0.92	29.6
Approach			400	2.9	400	2.9	0.468	20.2	LOS B	3.6	25.6	0.85	0.78	0.85	32.9
All Vehicles			1546	3.0	1546	3.0	0.698	18.8	LOS B	7.2	51.6	0.86	0.72	0.88	27.0

Site Level of Service (LOS) Method: Delay (RTA NSW). Site LOS Method is specified in the Network Data dialog (Override Site Data tab).

Vehicle movement LOS values are based on average delay per movement.

Intersection and Approach LOS values are based on average delay for all vehicle movements.

Delay Model: SIDRA Standard (Control Delay: Geometric Delay is included).

Queue Model: SIDRA queue estimation methods are used for Back of Queue and Queue at Start of Green.

Gap-Acceptance Capacity Formula: SIDRA Standard (Akçelik M3D).

HV (%) values are calculated for All Movement Classes of All Heavy Vehicle Model Designation.

Arrival Flows used in performance calculations are adjusted to include any Initial Queued Demand and Upstream Capacity Constraint effects.

* Critical Movement (Signal Timing)

Pedestrian Movement Performance											
Mov ID	Crossing	Dem. Flow ped/h	Aver. Delay sec	Level of Service	AVERAGE BACK OF QUEUE [Ped Dist]		Prop. Que	Eff. Stop Rate	Travel Time sec	Travel Dist. m	Aver. Speed m/sec
South: Bridge Road (S)											
P1	Full	3	19.9	LOS B	0.0	0.0	0.88	0.88	173.7	200.0	1.15
East: Grand Avenue											
P2	Full	21	19.9	LOS B	0.0	0.0	0.88	0.88	173.7	200.0	1.15
North: Bridge Road (N)											
P3	Full	15	19.9	LOS B	0.0	0.0	0.88	0.88	173.7	200.0	1.15
West: Veron Street											
P4	Full	6	19.9	LOS B	0.0	0.0	0.88	0.88	173.7	200.0	1.15
All Pedestrians		45	19.9	LOS B	0.0	0.0	0.88	0.88	173.7	200.0	1.15

Level of Service (LOS) Method: SIDRA Pedestrian LOS Method (Based on Average Delay)

Pedestrian movement LOS values are based on average delay per pedestrian movement.

Intersection LOS value for Pedestrians is based on average delay for all pedestrian movements.

SIDRA INTERSECTION 9.1 | Copyright © 2000-2023 Akcelik and Associates Pty Ltd | sidrasolutions.com

Organisation: SCT CONSULTING PTY LTD | Licence: NETWORK / 1PC | Processed: Tuesday, 17 October 2023 1:27:45 PM

Project: S:\Projects\SCT_00410_Cumberland Westmead Sth Transport Study\3. Technical Work Area\1. Network Optimisation\SCT_00410_Cumberland Westmead Sth_SIDRA_v0.5.sip9

MOVEMENT SUMMARY

Site: 21PM [BRI_MON_23_21PM_DL (Site Folder: Network 2)]

Output produced by SIDRA INTERSECTION Version: 9.1.4.221

Network: N101 [Network 2 - PM (Network Folder: Base Year_DL)]

Bridge Road and Entry to Monarco (5:00 to 6:00 PM)

Site Category: Base Year

Roundabout

Vehicle Movement Performance															
Mov ID	Turn	Mov Class	Demand Flows		Arrival Flows		Deg. Satn	Aver. Delay	Level of Service	Aver. Back Of Queue		Prop. Que	Eff. Stop Rate	Aver. No. of Cycles	Aver. Speed
			[Total	HV]	[Total	HV]				[Veh.	Dist]				
			veh/h	%	veh/h	%	v/c	sec		veh	m				km/h
South: Bridge Road (S)															
2	T1	All MCs	343	1.8	343	1.8	0.334	4.0	LOS A	0.8	5.6	0.17	0.49	0.17	41.2
3	R2	All MCs	61	0.0	61	0.0	0.334	6.7	LOS A	0.8	5.6	0.17	0.49	0.17	36.7
3u	U	All MCs	34	0.0	34	0.0	0.334	8.0	LOS A	0.8	5.6	0.17	0.49	0.17	32.5
Approach			438	1.4	438	1.4	0.334	4.7	LOS A	0.8	5.6	0.17	0.49	0.17	40.4
East: Monarco Entry															
4	L2	All MCs	61	0.0	61	0.0	0.253	8.8	LOS A	0.4	2.8	0.81	0.75	0.81	28.2
6	R2	All MCs	29	0.0	29	0.0	0.253	10.8	LOS A	0.4	2.8	0.81	0.75	0.81	37.2
6u	U	All MCs	1	0.0	1	0.0	0.253	12.1	LOS A	0.4	2.8	0.81	0.75	0.81	33.3
Approach			92	0.0	92	0.0	0.253	9.5	LOS A	0.4	2.8	0.81	0.75	0.81	32.8
North: Bridge Road (N)															
7	L2	All MCs	37	0.0	37	0.0	1.062	65.8	LOS E	21.2	149.1	1.00	1.67	2.27	16.9
8	T1	All MCs	699	0.8	699	0.8	1.062	64.9	LOS E	21.2	149.1	1.00	1.67	2.27	13.1
9u	U	All MCs	6	0.0	6	0.0	1.062	68.8	LOS E	21.2	149.1	1.00	1.67	2.27	20.1
Approach			742	0.7	742	0.7	1.062	65.0	LOS E	21.2	149.1	1.00	1.67	2.27	13.4
All Vehicles			1272	0.9	1271	0.9	1.062	40.2	LOS C	21.2	149.1	0.70	1.20	1.44	19.0

Site Level of Service (LOS) Method: Delay (RTA NSW). Site LOS Method is specified in the Network Data dialog (Override Site Data tab).

Vehicle movement LOS values are based on average delay per movement.

Intersection and Approach LOS values are based on average delay for all vehicle movements.

Roundabout Capacity Model: SIDRA Standard.

Delay Model: SIDRA Standard (Control Delay: Geometric Delay is included).

Queue Model: SIDRA queue estimation methods are used for Back of Queue and Queue at Start of Gap.

Gap-Acceptance Capacity Formula: SIDRA Standard (Akçelik M3D).

HV (%) values are calculated for All Movement Classes of All Heavy Vehicle Model Designation.

Arrival Flows used in performance calculations are adjusted to include any Initial Queued Demand and Upstream Capacity Constraint effects.

SIDRA INTERSECTION 9.1 | Copyright © 2000-2023 Akcelik and Associates Pty Ltd | sidrasolutions.com

Organisation: SCT CONSULTING PTY LTD | Licence: NETWORK / 1PC | Processed: Tuesday, 17 October 2023 1:27:53 PM

Project: S:\Projects\SCT_00410_Cumberland Westmead Sth Transport Study\3. Technical Work Area\1. Network Optimisation\SCT_00410_Cumberland Westmead Sth_SIDRA_v0.5.sip9

MOVEMENT SUMMARY

Site: 24PM [BRI_ALE_23_24PM_DL (Site Folder: Network 2)]

Output produced by SIDRA INTERSECTION Version: 9.1.4.221

Network: N101 [Network 2 - PM (Network Folder: Base Year_DL)]

Bridge Road and Alexandra Avenue (5:00 to 6:00 PM)

Site Category: Base Year

Roundabout

Vehicle Movement Performance															
Mov ID	Turn	Mov Class	Demand Flows		Arrival Flows		Deg. Satn	Aver. Delay	Level of Service	Aver. Back Of Queue		Prop. Que	Eff. Stop Rate	Aver. No. of Cycles	Aver. Speed
			[Total	HV]	[Total	HV]				[Veh.	Dist]				
			veh/h	%	veh/h	%	v/c	sec		veh	m				km/h
South: Bridge Road (S)															
2	T1	All MCs	461	1.8	461	1.8	0.491	4.2	LOS A	1.1	8.1	0.30	0.54	0.30	26.0
3	R2	All MCs	133	0.0	133	0.0	0.491	7.2	LOS A	1.1	8.1	0.30	0.54	0.30	43.5
3u	U	All MCs	2	0.0	2	0.0	0.491	8.6	LOS A	1.1	8.1	0.30	0.54	0.30	26.0
Approach			596	1.4	596	1.4	0.491	4.9	LOS A	1.1	8.1	0.30	0.54	0.30	36.5
East: Alexandra Avenue															
4	L2	All MCs	176	0.0	176	0.0	0.606	8.7	LOS A	1.4	9.6	0.85	0.82	0.98	41.3
6	R2	All MCs	147	0.0	147	0.0	0.606	11.0	LOS A	1.4	9.6	0.85	0.82	0.98	41.3
6u	U	All MCs	1	0.0	1	0.0	0.606	12.4	LOS A	1.4	9.6	0.85	0.82	0.98	44.2
Approach			324	0.0	324	0.0	0.606	9.8	LOS A	1.4	9.6	0.85	0.82	0.98	41.4
North: Bridge Road (N)															
7	L2	All MCs	159	0.7	152	0.7	1.132	131.0	LOS F	16.7	118.0	1.00	2.40	3.57	14.7
8	T1	All MCs	731	1.3	697	1.3	1.132	130.7	LOS F	16.7	118.0	1.00	2.40	3.57	3.4
9u	U	All MCs	1	0.0	1	0.0	1.132	134.9	LOS F	16.7	118.0	1.00	2.40	3.57	3.4
Approach			891	1.2	850	1.2	1.132	130.7	LOS F	16.7	118.0	1.00	2.40	3.57	6.0
All Vehicles			1811	1.0	1770	1.1	1.132	66.2	LOS E	16.7	118.0	0.74	1.48	2.00	12.6

Site Level of Service (LOS) Method: Delay (RTA NSW). Site LOS Method is specified in the Network Data dialog (Override Site Data tab).

Vehicle movement LOS values are based on average delay per movement.

Intersection and Approach LOS values are based on average delay for all vehicle movements.

Roundabout Capacity Model: SIDRA Standard.

Delay Model: SIDRA Standard (Control Delay: Geometric Delay is included).

Queue Model: SIDRA queue estimation methods are used for Back of Queue and Queue at Start of Gap.

Gap-Acceptance Capacity Formula: SIDRA Standard (Akçelik M3D).

HV (%) values are calculated for All Movement Classes of All Heavy Vehicle Model Designation.

Arrival Flows used in performance calculations are adjusted to include any Initial Queued Demand and Upstream Capacity Constraint effects.

SIDRA INTERSECTION 9.1 | Copyright © 2000-2023 Akcelik and Associates Pty Ltd | sidrasolutions.com

Organisation: SCT CONSULTING PTY LTD | Licence: NETWORK / 1PC | Processed: Tuesday, 17 October 2023 1:27:53 PM

Project: S:\Projects\SCT_00410_Cumberland Westmead Sth Transport Study\3. Technical Work Area\1. Network Optimisation\SCT_00410_Cumberland Westmead Sth_SIDRA_v0.5.sip9

MOVEMENT SUMMARY

Site: 2PM [BRI_GRA_23_2PM_DL (Site Folder: Network 2)]

Output produced by SIDRA INTERSECTION Version: 9.1.4.221

Network: N101 [Network 2 - PM (Network Folder: Base Year_DL)]

Bridge Road and Grand Avenue (5:00 to 6:00 PM)

TCS 1570

Site Category: Base Year

Signals - EQUISAT (Fixed-Time/SCATS) Isolated Cycle Time = 65 seconds (Site User-Given Phase Times)

Vehicle Movement Performance															
Mov ID	Turn	Mov Class	Demand Flows		Arrival Flows		Deg. Satn	Aver. Delay	Level of Service	Aver. Back Of Queue		Prop. Que	Eff. Stop Rate	Aver. No. of Cycles	Aver. Speed
			[Total	HV]	[Total	HV]				[Veh.	Dist]				
			veh/h	%	veh/h	%	v/c	sec		veh	m				km/h
South: Bridge Road (S)															
1	L2	All MCs	64	0.0	64	0.0	0.149	23.2	LOS B	1.1	8.0	0.79	0.70	0.79	30.3
2	T1	All MCs	321	1.0	321	1.0	*0.575	22.3	LOS B	5.3	37.4	0.91	0.77	0.91	7.3
Approach			385	0.8	385	0.8	0.575	22.4	LOS B	5.3	37.4	0.89	0.76	0.89	14.6
East: Grand Avenue															
4	L2	All MCs	13	0.0	13	0.0	0.203	28.3	LOS B	1.4	9.9	0.86	0.68	0.86	32.1
5	T1	All MCs	72	0.0	72	0.0	*0.203	23.7	LOS B	1.4	9.9	0.86	0.68	0.86	38.1
6	R2	All MCs	1	100.0	1	100.0	0.203	29.4	LOS C	1.4	9.9	0.86	0.68	0.86	32.2
Approach			85	1.2	85	1.2	0.203	24.4	LOS B	1.4	9.9	0.86	0.68	0.86	37.4
North: Bridge Road (N)															
7	L2	All MCs	18	0.0	16	0.0	0.201	19.8	LOS B	2.0	14.3	0.47	0.41	0.47	42.8
8	T1	All MCs	534	0.6	466	0.6	0.788	20.4	LOS B	8.5	59.9	0.70	0.72	0.77	18.2
9	R2	All MCs	334	0.9	292	0.9	*0.788	37.9	LOS C	8.5	59.9	0.92	1.01	1.05	30.8
Approach			885	0.7	774	0.7	0.788	27.0	LOS B	8.5	59.9	0.78	0.82	0.87	21.4
West: Veron Street															
10	L2	All MCs	263	2.0	263	2.0	0.266	13.4	LOS A	2.7	19.1	0.56	0.71	0.56	36.4
11	T1	All MCs	16	0.0	16	0.0	0.193	22.7	LOS B	1.1	7.9	0.87	0.72	0.87	36.7
12	R2	All MCs	52	0.0	52	0.0	0.193	29.1	LOS C	1.1	7.9	0.87	0.72	0.87	27.9
Approach			331	1.6	331	1.6	0.266	16.3	LOS B	2.7	19.1	0.62	0.71	0.62	34.8
All Vehicles			1686	0.9	1575	1.0	0.788	23.5	LOS B	8.5	59.9	0.78	0.77	0.82	25.1

Site Level of Service (LOS) Method: Delay (RTA NSW). Site LOS Method is specified in the Network Data dialog (Override Site Data tab).

Vehicle movement LOS values are based on average delay per movement.

Intersection and Approach LOS values are based on average delay for all vehicle movements.

Delay Model: SIDRA Standard (Control Delay: Geometric Delay is included).

Queue Model: SIDRA queue estimation methods are used for Back of Queue and Queue at Start of Green.

Gap-Acceptance Capacity Formula: SIDRA Standard (Akçelik M3D).

HV (%) values are calculated for All Movement Classes of All Heavy Vehicle Model Designation.

Arrival Flows used in performance calculations are adjusted to include any Initial Queued Demand and Upstream Capacity Constraint effects.

* Critical Movement (Signal Timing)

Pedestrian Movement Performance											
Mov ID	Crossing	Dem. Flow ped/h	Aver. Delay sec	Level of Service	AVERAGE BACK OF QUEUE [Ped Dist]		Prop. Que	Eff. Stop Rate	Travel Time sec	Travel Dist. m	Aver. Speed m/sec
South: Bridge Road (S)											
P1	Full	4	26.8	LOS C	0.0	0.0	0.91	0.91	180.6	200.0	1.11
East: Grand Avenue											
P2	Full	11	26.8	LOS C	0.0	0.0	0.91	0.91	180.6	200.0	1.11
North: Bridge Road (N)											
P3	Full	25	26.8	LOS C	0.0	0.0	0.91	0.91	180.7	200.0	1.11
West: Veron Street											
P4	Full	3	26.8	LOS C	0.0	0.0	0.91	0.91	180.6	200.0	1.11
All Pedestrians		43	26.8	LOS C	0.0	0.0	0.91	0.91	180.6	200.0	1.11

Level of Service (LOS) Method: SIDRA Pedestrian LOS Method (Based on Average Delay)

Pedestrian movement LOS values are based on average delay per pedestrian movement.

Intersection LOS value for Pedestrians is based on average delay for all pedestrian movements.

SIDRA INTERSECTION 9.1 | Copyright © 2000-2023 Akcelik and Associates Pty Ltd | sidrasolutions.com

Organisation: SCT CONSULTING PTY LTD | Licence: NETWORK / 1PC | Processed: Tuesday, 17 October 2023 1:27:53 PM

Project: S:\Projects\SCT_00410_Cumberland Westmead Sth Transport Study\3. Technical Work Area\1. Network Optimisation\SCT_00410_Cumberland Westmead Sth_SIDRA_v0.5.sip9

MOVEMENT SUMMARY

Site: 4AM [BRI_GWH_23_4AM (Site Folder: Network 3)]

Output produced by SIDRA INTERSECTION Version: 9.1.4.221

Network: N101 [Network 3 - AM (Network Folder: Base Year_DL)]

Bridge Road and Great Western Highway

TCS 1248 - SS 2

8:00 AM to 9:00 AM Base year demand

Site Category: Base Year

Signals - EQUISAT (Fixed-Time/SCATS) Coordinated Cycle Time = 141 seconds (Network User-Given Cycle Time)

Vehicle Movement Performance															
Mov ID	Turn	Mov Class	Demand Flows [Total HV]		Arrival Flows [Total HV]		Deg. Satn	Aver. Delay	Level of Service	Aver. Back Of Queue [Veh. Dist]		Prop. Que	Eff. Stop Rate	Aver. No. of Cycles	Aver. Speed
			veh/h	%	veh/h	%	v/c	sec		veh	m				km/h
East: Great Western Highway (E)															
5	T1	All MCs	998	5.9	998	5.9	0.366	6.4	LOS A	7.6	55.9	0.32	0.29	0.32	52.1
6	R2	All MCs	305	0.7	305	0.7	*0.536	22.4	LOS B	5.6	39.5	0.73	0.83	0.73	37.5
Approach			1303	4.7	1303	4.7	0.536	10.2	LOS A	7.6	55.9	0.42	0.41	0.42	45.5
North: Hawkesbury Road (N)															
7	L2	All MCs	146	1.4	146	1.4	0.169	13.0	LOS A	1.4	10.3	0.25	0.60	0.25	40.5
9	R2	All MCs	236	0.9	236	0.9	*0.693	54.1	LOS D	8.9	62.6	0.93	0.82	0.94	32.3
Approach			382	1.1	382	1.1	0.693	38.3	LOS C	8.9	62.6	0.67	0.74	0.68	34.2
West: Great Western Highway (W)															
10	L2	All MCs	151	2.1	151	2.1	0.240	18.9	LOS B	2.5	19.4	0.37	0.63	0.37	43.4
11	T1	All MCs	1184	5.2	1184	5.2	*0.693	14.5	LOS A	13.5	97.1	0.58	0.53	0.58	40.7
Approach			1335	4.9	1335	4.9	0.693	15.0	LOS B	13.5	97.1	0.56	0.54	0.56	41.4
All Vehicles			3020	4.3	3020	4.3	0.693	15.9	LOS B	13.5	97.1	0.51	0.51	0.51	41.2

Site Level of Service (LOS) Method: Delay (RTA NSW). Site LOS Method is specified in the Network Data dialog (Override Site Data tab).

Vehicle movement LOS values are based on average delay per movement.

Intersection and Approach LOS values are based on average delay for all vehicle movements.

Delay Model: SIDRA Standard (Control Delay: Geometric Delay is included).

Queue Model: SIDRA queue estimation methods are used for Back of Queue and Queue at Start of Green.

Gap-Acceptance Capacity Formula: SIDRA Standard (Akçelik M3D).

HV (%) values are calculated for All Movement Classes of All Heavy Vehicle Model Designation.

Arrival Flows used in performance calculations are adjusted to include any Initial Queued Demand and Upstream Capacity Constraint effects.

* Critical Movement (Signal Timing)

Pedestrian Movement Performance											
Mov ID	Crossing	Dem. Flow ped/h	Aver. Delay sec	Level of Service	AVERAGE BACK OF QUEUE [Ped Dist] ped m		Prop. Que	Eff. Stop Rate	Travel Time sec	Travel Dist. m	Aver. Speed m/sec
North: Hawkesbury Road (N)											
P3	Full	47	64.8	LOS F	0.2	0.2	0.96	0.96	218.6	200.0	0.91
West: Great Western Highway (W)											
P4	Full	18	64.7	LOS F	0.1	0.1	0.96	0.96	218.5	200.0	0.92
All Pedestrians		65	64.7	LOS F	0.2	0.2	0.96	0.96	218.6	200.0	0.91

Level of Service (LOS) Method: SIDRA Pedestrian LOS Method (Based on Average Delay)
 Pedestrian movement LOS values are based on average delay per pedestrian movement.
 Intersection LOS value for Pedestrians is based on average delay for all pedestrian movements.

MOVEMENT SUMMARY

Site: 5AM [HAW_GWH_23_5AM_DL (Site Folder: Network 3)]

Output produced by SIDRA INTERSECTION Version: 9.1.4.221

Network: N101 [Network 3 - AM (Network Folder: Base Year_DL)]

TCS 502 - SS 2

8:00 AM to 9:00 AM Base year demand

Site Category: Base Year

Signals - EQUISAT (Fixed-Time/SCATS) Coordinated Cycle Time = 141 seconds (Network User-Given Cycle Time)

Vehicle Movement Performance															
Mov ID	Turn	Mov Class	Demand Flows [Total HV]	Flows %	Arrival Flows [Total HV]	Flows %	Deg. Satn	Aver. Delay	Level of Service	Aver. Back Of Queue [Veh. Dist]	Prop. Que	Eff. Stop Rate	Aver. No. of Cycles	Aver. Speed	
			veh/h	%	veh/h	%	v/c	sec		veh	m			km/h	
South: Coleman Street (S)															
1	L2	All MCs	365	1.7	365	1.7	0.521	43.2	LOS D	12.0	85.1	0.84	0.82	0.84	25.0
2	T1	All MCs	482	2.0	482	2.0	*0.753	60.3	LOS E	11.8	83.8	1.00	0.88	1.05	30.3
3	R2	All MCs	84	1.2	84	1.2	0.753	65.7	LOS E	11.4	81.1	1.00	0.88	1.05	29.4
Approach			932	1.8	932	1.8	0.753	54.1	LOS D	12.0	85.1	0.94	0.86	0.97	28.7
East: Great Western Highway (E)															
4	L2	All MCs	55	7.7	55	7.7	0.042	7.3	LOS A	0.3	2.2	0.21	0.60	0.21	51.7
5	T1	All MCs	593	6.9	593	6.9	0.593	36.8	LOS C	10.0	74.3	0.78	0.67	0.78	28.7
6	R2	All MCs	59	1.8	59	1.8	0.317	51.3	LOS D	2.0	13.9	0.80	0.76	0.80	33.5
Approach			706	6.6	706	6.6	0.593	35.7	LOS C	10.0	74.3	0.73	0.67	0.73	30.0
North: Hawkesbury Road (N)															
7	L2	All MCs	60	0.0	60	0.0	0.170	56.8	LOS E	2.1	14.8	0.87	0.75	0.87	30.4
8	T1	All MCs	128	2.5	128	2.5	0.566	55.3	LOS D	8.1	58.0	0.96	0.81	0.96	31.0
9	R2	All MCs	344	3.7	344	3.7	*0.755	64.5	LOS E	10.8	77.8	0.99	0.86	1.03	19.8
Approach			533	3.0	533	3.0	0.755	61.4	LOS E	10.8	77.8	0.97	0.83	1.00	24.3
West: Great Western Highway (W)															
10	L2	All MCs	208	3.5	208	3.5	0.226	8.5	LOS A	1.1	8.2	0.12	0.57	0.12	46.3
11	T1	All MCs	989	5.3	989	5.3	*0.750	12.5	LOS A	7.4	53.1	0.37	0.34	0.37	48.3
12	R2	All MCs	133	3.2	133	3.2	0.367	26.5	LOS B	2.0	14.2	0.51	0.68	0.51	38.3
Approach			1331	4.8	1331	4.8	0.750	13.3	LOS A	7.4	53.1	0.35	0.41	0.35	43.5
All Vehicles			3501	4.1	3501	4.1	0.755	36.0	LOS C	12.0	85.1	0.68	0.65	0.69	31.7

Site Level of Service (LOS) Method: Delay (RTA NSW). Site LOS Method is specified in the Network Data dialog (Override Site Data tab).

Vehicle movement LOS values are based on average delay per movement.

Intersection and Approach LOS values are based on average delay for all vehicle movements.

Delay Model: SIDRA Standard (Control Delay: Geometric Delay is included).

Queue Model: SIDRA queue estimation methods are used for Back of Queue and Queue at Start of Green.

Gap-Acceptance Capacity Formula: SIDRA Standard (Akçelik M3D).

HV (%) values are calculated for All Movement Classes of All Heavy Vehicle Model Designation.

Arrival Flows used in performance calculations are adjusted to include any Initial Queued Demand and Upstream Capacity Constraint effects.

* Critical Movement (Signal Timing)

Pedestrian Movement Performance											
Mov ID	Crossing	Dem. Flow ped/h	Aver. Delay sec	Level of Service	AVERAGE BACK OF QUEUE [Ped Dist]		Prop. Que	Eff. Stop Rate	Travel Time sec	Travel Dist. m	Aver. Speed m/sec
South: Coleman Street (S)											
P1	Full	6	64.6	LOS F	0.0	0.0	0.96	0.96	218.5	200.0	0.92
East: Great Western Highway (E)											
P2	Full	16	64.7	LOS F	0.1	0.1	0.96	0.96	218.5	200.0	0.92
North: Hawkesbury Road (N)											
P3	Full	44	64.7	LOS F	0.2	0.2	0.96	0.96	218.6	200.0	0.91
All Pedestrians		66	64.7	LOS F	0.2	0.2	0.96	0.96	218.6	200.0	0.92

Level of Service (LOS) Method: SIDRA Pedestrian LOS Method (Based on Average Delay)

Pedestrian movement LOS values are based on average delay per pedestrian movement.

Intersection LOS value for Pedestrians is based on average delay for all pedestrian movements.

SIDRA INTERSECTION 9.1 | Copyright © 2000-2023 Akcelik and Associates Pty Ltd | sidrasolutions.com

Organisation: SCT CONSULTING PTY LTD | Licence: NETWORK / 1PC | Processed: Tuesday, 17 October 2023 1:22:29 PM

Project: S:\Projects\SCT_00410_Cumberland Westmead Sth Transport Study\3. Technical Work Area\1. Network Optimisation\SCT_00410_Cumberland Westmead Sth_SIDRA_v0.5.sip9

MOVEMENT SUMMARY

Site: 4PM [BRI_GWH_23_4PM (Site Folder: Network 3)]

Output produced by SIDRA INTERSECTION Version: 9.1.4.221

Network: N102 [Network 3 - PM (Network Folder: Base Year_DL)]

Bridge Road and Great Western Highway

TCS 1248 - SS 2

5:00 PM to 6:00 PM Base year demand

Site Category: Base Year

Signals - EQUISAT (Fixed-Time/SCATS) Coordinated Cycle Time = 100 seconds (Network User-Given Cycle Time)

Vehicle Movement Performance															
Mov ID	Turn	Mov Class	Demand Flows [Total HV]		Arrival Flows [Total HV]		Deg. Satn	Aver. Delay	Level of Service	Aver. Back Of Queue [Veh. Dist]		Prop. Que	Eff. Stop Rate	Aver. No. of Cycles	Aver. Speed
			veh/h	%	veh/h	%	v/c	sec		veh	m				km/h
East: Great Western Highway (E)															
5	T1	All MCs	1696	2.9	1696	2.9	0.661	2.5	LOS A	6.5	46.7	0.28	0.26	0.28	56.1
6	R2	All MCs	313	2.0	313	2.0	*0.510	18.9	LOS B	4.2	29.7	0.87	0.82	0.87	38.2
Approach			2008	2.8	2008	2.8	0.661	5.1	LOS A	6.5	46.7	0.37	0.35	0.37	51.1
North: Hawkesbury Road (N)															
7	L2	All MCs	156	0.7	156	0.7	0.159	27.0	LOS B	3.9	27.4	0.90	0.57	0.90	33.7
9	R2	All MCs	265	0.4	265	0.4	*0.651	50.9	LOS D	7.9	55.3	1.00	0.87	1.00	33.0
Approach			421	0.5	421	0.5	0.651	42.0	LOS C	7.9	55.3	0.96	0.76	0.96	33.2
West: Great Western Highway (W)															
10	L2	All MCs	64	0.0	64	0.0	0.132	28.1	LOS B	1.5	11.6	0.68	0.70	0.68	40.0
11	T1	All MCs	904	2.9	904	2.9	*0.658	18.2	LOS B	9.2	65.5	0.72	0.63	0.72	37.7
Approach			968	2.7	968	2.7	0.658	18.8	LOS B	9.2	65.5	0.72	0.64	0.72	38.0
All Vehicles			3398	2.5	3398	2.5	0.661	13.6	LOS A	9.2	65.5	0.55	0.48	0.55	43.0

Site Level of Service (LOS) Method: Delay (RTA NSW). Site LOS Method is specified in the Network Data dialog (Override Site Data tab).

Vehicle movement LOS values are based on average delay per movement.

Intersection and Approach LOS values are based on average delay for all vehicle movements.

Delay Model: SIDRA Standard (Control Delay: Geometric Delay is included).

Queue Model: SIDRA queue estimation methods are used for Back of Queue and Queue at Start of Green.

Gap-Acceptance Capacity Formula: SIDRA Standard (Akçelik M3D).

HV (%) values are calculated for All Movement Classes of All Heavy Vehicle Model Designation.

Arrival Flows used in performance calculations are adjusted to include any Initial Queued Demand and Upstream Capacity Constraint effects.

* Critical Movement (Signal Timing)

Pedestrian Movement Performance											
Mov ID	Crossing	Dem. Flow ped/h	Aver. Delay sec	Level of Service	AVERAGE BACK OF QUEUE [Ped Dist] ped m		Prop. Que	Eff. Stop Rate	Travel Time sec	Travel Dist. m	Aver. Speed m/sec
North: Hawkesbury Road (N)											
P3	Full	21	44.2	LOS E	0.1	0.1	0.94	0.94	198.1	200.0	1.01
West: Great Western Highway (W)											
P4	Full	7	44.2	LOS E	0.0	0.0	0.94	0.94	198.0	200.0	1.01
All Pedestrians		28	44.2	LOS E	0.1	0.1	0.94	0.94	198.1	200.0	1.01

Level of Service (LOS) Method: SIDRA Pedestrian LOS Method (Based on Average Delay)
 Pedestrian movement LOS values are based on average delay per pedestrian movement.
 Intersection LOS value for Pedestrians is based on average delay for all pedestrian movements.

MOVEMENT SUMMARY

Site: 5PM [HAW_GWH_23_5PM_DL (Site Folder: Network 3)]

Output produced by SIDRA INTERSECTION Version: 9.1.4.221

Network: N102 [Network 3 - PM (Network Folder: Base Year_DL)]

TCS 502 - SS 2

5:00 PM to 6:00 PM Base year demand

Site Category: Base Year

Signals - EQUISAT (Fixed-Time/SCATS) Coordinated Cycle Time = 100 seconds (Network User-Given Cycle Time)

Vehicle Movement Performance															
Mov ID	Turn	Mov Class	Demand Flows [Total HV]	Flows %	Arrival Flows [Total HV]	Flows %	Deg. Satn	Aver. Delay	Level of Service	Aver. Back Of Queue [Veh. Dist]	Prop. Que	Eff. Stop Rate	Aver. No. of Cycles	Aver. Speed	
			veh/h	%	veh/h	%	v/c	sec		veh	m				km/h
South: Coleman Street (S)															
1	L2	All MCs	473	2.0	473	2.0	0.802	45.6	LOS D	8.4	59.8	0.96	0.87	1.03	24.1
2	T1	All MCs	189	1.1	189	1.1	* 0.802	53.8	LOS D	8.4	59.8	1.00	0.94	1.19	32.3
3	R2	All MCs	53	4.0	53	4.0	0.802	57.4	LOS E	5.9	42.3	1.00	0.94	1.21	31.5
Approach			715	1.9	715	1.9	0.802	48.7	LOS D	8.4	59.8	0.98	0.89	1.09	27.5
East: Great Western Highway (E)															
4	L2	All MCs	61	0.0	61	0.0	0.045	7.4	LOS A	0.3	2.1	0.26	0.61	0.26	51.8
5	T1	All MCs	1065	4.1	1065	4.1	* 0.875	43.4	LOS D	19.2	138.9	0.95	0.92	1.04	28.2
6	R2	All MCs	27	0.0	27	0.0	0.096	43.5	LOS D	0.6	3.9	0.69	0.70	0.69	39.8
Approach			1154	3.7	1154	3.7	0.875	41.5	LOS C	19.2	138.9	0.91	0.90	1.00	26.7
North: Hawkesbury Road (N)															
7	L2	All MCs	40	2.6	40	2.6	0.100	39.2	LOS C	1.0	6.9	0.83	0.72	0.83	35.5
8	T1	All MCs	146	1.4	146	1.4	0.642	38.8	LOS C	7.4	52.2	0.96	0.82	0.96	35.9
9	R2	All MCs	469	0.4	469	0.4	* 0.855	51.6	LOS D	11.4	80.0	0.99	0.93	1.15	22.9
Approach			656	0.8	656	0.8	0.855	48.0	LOS D	11.4	80.0	0.97	0.89	1.09	27.2
West: Great Western Highway (W)															
10	L2	All MCs	162	0.0	162	0.0	0.149	7.1	LOS A	0.5	3.7	0.10	0.57	0.10	47.8
11	T1	All MCs	763	3.0	763	3.0	0.529	14.9	LOS B	5.7	40.6	0.52	0.46	0.52	45.6
12	R2	All MCs	135	3.1	135	3.1	* 0.599	31.8	LOS C	2.2	15.7	0.89	0.77	0.89	34.5
Approach			1060	2.6	1060	2.6	0.599	15.9	LOS B	5.7	40.6	0.50	0.51	0.50	41.4
All Vehicles			3584	2.5	3584	2.5	0.875	36.5	LOS C	19.2	138.9	0.81	0.78	0.88	30.1

Site Level of Service (LOS) Method: Delay (RTA NSW). Site LOS Method is specified in the Network Data dialog (Override Site Data tab).

Vehicle movement LOS values are based on average delay per movement.

Intersection and Approach LOS values are based on average delay for all vehicle movements.

Delay Model: SIDRA Standard (Control Delay: Geometric Delay is included).

Queue Model: SIDRA queue estimation methods are used for Back of Queue and Queue at Start of Green.

Gap-Acceptance Capacity Formula: SIDRA Standard (Akçelik M3D).

HV (%) values are calculated for All Movement Classes of All Heavy Vehicle Model Designation.

Arrival Flows used in performance calculations are adjusted to include any Initial Queued Demand and Upstream Capacity Constraint effects.

* Critical Movement (Signal Timing)

Pedestrian Movement Performance											
Mov ID	Crossing	Dem. Flow ped/h	Aver. Delay sec	Level of Service	AVERAGE BACK OF QUEUE [Ped Dist]		Prop. Que	Eff. Stop Rate	Travel Time sec	Travel Dist. m	Aver. Speed m/sec
South: Coleman Street (S)											
P1	Full	14	44.2	LOS E	0.0	0.0	0.94	0.94	198.1	200.0	1.01
East: Great Western Highway (E)											
P2	Full	8	44.2	LOS E	0.0	0.0	0.94	0.94	198.0	200.0	1.01
North: Hawkesbury Road (N)											
P3	Full	26	44.2	LOS E	0.1	0.1	0.94	0.94	198.1	200.0	1.01
All Pedestrians		48	44.2	LOS E	0.1	0.1	0.94	0.94	198.1	200.0	1.01

Level of Service (LOS) Method: SIDRA Pedestrian LOS Method (Based on Average Delay)

Pedestrian movement LOS values are based on average delay per pedestrian movement.

Intersection LOS value for Pedestrians is based on average delay for all pedestrian movements.

NETWORK LAYOUT

Network: N101 [Network 1 - AM (Network Folder: Base Year_DL)]

New Network
Network Category: (None)

Layout pictures are schematic functional drawings reflecting input data. They are not design drawings.

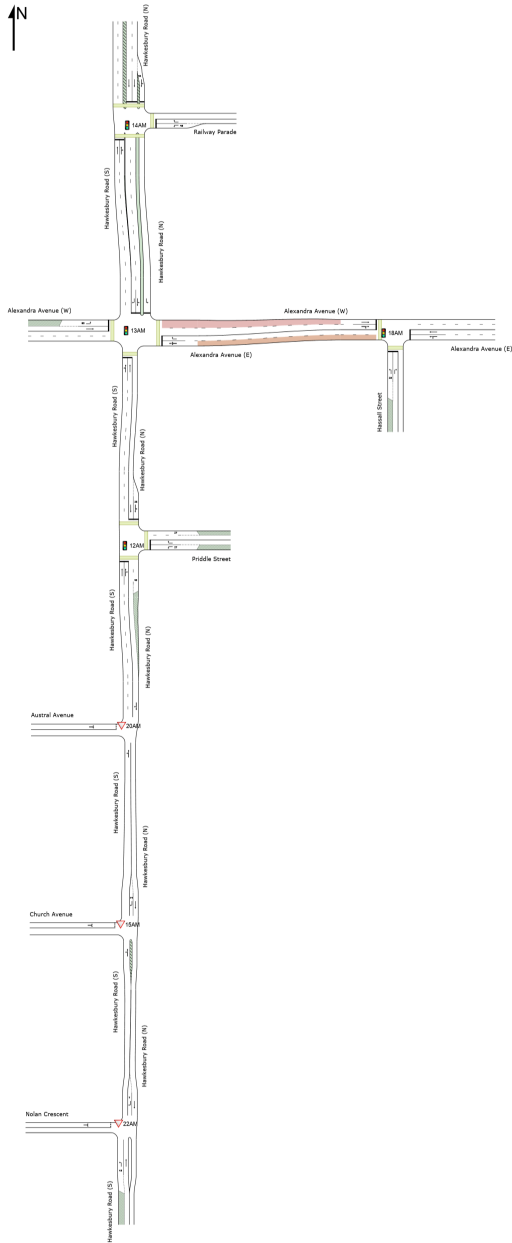

SITES IN NETWORK		
Site ID	CCG ID	Site Name
📱 14AM	CCG1	HAW_RAI_23_14AM_DL
📱 13AM	CCG1	HAW_ALE_23_13AM_DL
📱 12AM	NA	HAW_PRI_23_12AM_DL
▽ 22AM	NA	HAW_NOL_23_22AM_DL
▽ 15AM	NA	HAW_CHU_23_15AM_DL
▽ 20AM	NA	HAW_AUS_23_20AM_DL
📱 18AM	NA	ALE_HAS_23_18AM_DL

SIDRA INTERSECTION 9.1 | Copyright © 2000-2023 Akcelik and Associates Pty Ltd | sidrasolutions.com

Organisation: SCT CONSULTING PTY LTD | Licence: NETWORK / 1PC | Created: Thursday, 19 October 2023 4:29:24 PM
Project: S:\Projects\SCT_00410_Cumberland Westmead Sth Transport Study\3. Technical Work Area\1. Network Optimisation
\SCT_00410_Cumberland Westmead Sth_SIDRA_v0.5_upg1_sg.sip9

NETWORK LAYOUT

■ Network: N101 [Network 2 - AM (Network Folder: Base Year_DL)]

New Network
 Network Category: (None)

Layout pictures are schematic functional drawings reflecting input data. They are not design drawings.

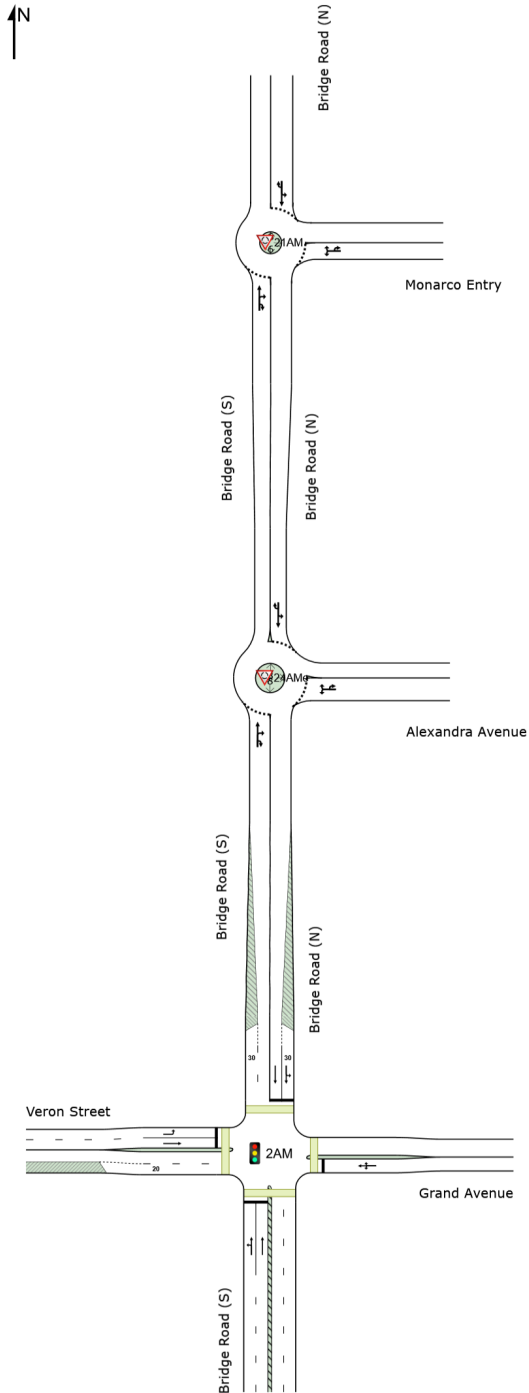

SITES IN NETWORK		
Site ID	CCG ID	Site Name
▼ 21AM	NA	BRI_MON_23_21AM_DL
▼ 24AMe	NA	BRI_ALE_23_24AM_DL
■ 2AM	NA	BRI_GRA_23_2AM_DL

SIDRA INTERSECTION 9.1 | Copyright © 2000-2023 Akcelik and Associates Pty Ltd | sidrasolutions.com

Organisation: SCT CONSULTING PTY LTD | Licence: NETWORK / 1PC | Created: Thursday, 19 October 2023 4:29:26 PM
Project: S:\Projects\SCT_00410_Cumberland Westmead Sth Transport Study\3. Technical Work Area\1. Network Optimisation
\SCT_00410_Cumberland Westmead Sth_SIDRA_v0.5_upg1_sg.sip9

NETWORK LAYOUT

Network: N101 [Network 3 - AM (Network Folder: Base Year_DL)]

New Network
 Network Category: (None)

Layout pictures are schematic functional drawings reflecting input data. They are not design drawings.

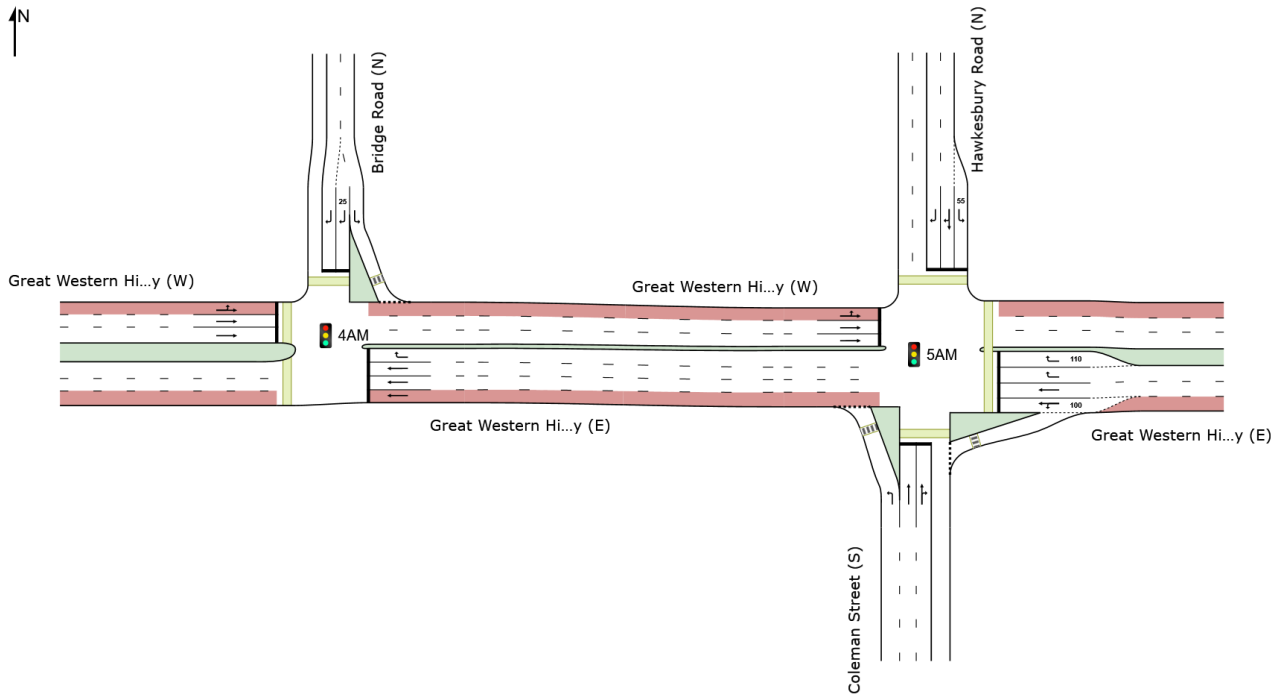

SITES IN NETWORK		
Site ID	CCG ID	Site Name
4AM	NA	BRI_GWH_23_4AM_O2
5AM	NA	HAW_GWH_23_5AM_DL_O2

SIDRA INTERSECTION 9.1 | Copyright © 2000-2023 Akcelik and Associates Pty Ltd | sidrasolutions.com
 Organisation: SCT CONSULTING PTY LTD | Licence: NETWORK / 1PC | Created: Thursday, 19 October 2023 4:29:28 PM
 Project: S:\Projects\SCT_00410_Cumberland Westmead Sth Transport Study\3. Technical Work Area\1. Network Optimisation
 \SCT_00410_Cumberland Westmead Sth_SIDRA_v0.5_upg1_sg.sip9

CCG MOVEMENT SUMMARY

Common Control Group: CCG1 [TCS 1571]

Output produced by SIDRA INTERSECTION Version: 9.1.4.221

Network: N101 [Network 1 - AM (Network Folder: Base Year_DL)]

EQUISAT (Fixed-Time/SCATS) Coordinated Cycle Time = 110 seconds (Network Practical Cycle Time)

Vehicle Movement Performance (CCG)															
Mov ID	Turn	Mov Class	Demand Flows		Arrival Flows		Deg. Satn	Aver. Delay	Level of Service	95% Back Of Queue		Prop. Que	Eff. Stop Rate	Aver. No. of Cycles	Aver. Speed
			[Total	HV]	[Total	HV]				[Veh.	Dist]				
Site: 14AM [HAW_RAI_23_14AM_DL]															
South: Hawkesbury Road (S)															
2	T1	All MCs	841	2.0	691	2.0	0.492	15.2	LOS B	12.6	89.8	0.76	0.51	0.76	21.2
3	R2	All MCs	434	2.0	357	2.0	0.492	19.1	LOS B	12.6	89.8	0.69	0.70	0.69	31.2
Approach			1274	2.0	1048	2.0	0.492	16.5	LOS B	12.6	89.8	0.74	0.57	0.74	26.7
East: Railway Parade															
4	L2	All MCs	71	2.0	71	2.0	0.072	15.9	LOS B	1.8	12.5	0.50	0.62	0.50	31.2
6	R2	All MCs	7	2.0	7	2.0	0.027	45.9	LOS D	0.3	2.4	0.87	0.64	0.87	23.8
Approach			79	2.0	79	2.0	0.072	18.7	LOS B	1.8	12.5	0.53	0.62	0.53	30.1
North: Hawkesbury Road (N)															
7	L2	All MCs	93	2.0	93	2.0	0.182	33.4	LOS C	3.8	27.8	0.77	0.72	0.77	26.7
8	T1	All MCs	229	16.9	229	16.9	0.182	26.9	LOS B	4.2	33.6	0.74	0.60	0.74	12.9
Approach			322	12.6	322	12.6	0.182	28.8	LOS C	4.2	33.6	0.75	0.63	0.75	19.9
All Vehicles			1675	4.0	1449	4.7	0.492	19.4	LOS B	12.6	89.8	0.73	0.59	0.73	25.3
Site: 13AM [HAW_ALE_23_13AM_DL]															
South: Hawkesbury Road (S)															
1	L2	All MCs	1	0.0	1	0.0	1.140	170.1	LOS F	27.5	195.9	1.00	1.74	2.12	13.1
2	T1	All MCs	533	2.0	533	2.0	* 1.140	164.4	LOS F	27.5	195.9	1.00	1.74	2.12	4.0
Approach			534	2.0	534	2.0	1.140	164.4	LOS F	27.5	195.9	1.00	1.74	2.12	4.0
East: Alexandra Avenue (E)															
4	L2	All MCs	1	0.0	1	0.0	1.118	178.4	LOS F	35.1	249.7	1.00	1.76	2.07	3.5
5	T1	All MCs	686	2.0	502	2.0	* 1.118	167.7	LOS F	35.1	249.7	1.00	1.76	2.07	12.8
6	R2	All MCs	515	2.0	376	2.0	1.118	178.6	LOS F	35.1	249.7	1.00	1.60	2.15	3.3

Approach			1202	2.0	879	2.0	1.118	172.4	LOS F	35.1	249.7	1.00	1.69	2.10	9.1
North: Hawkesbury Road (N)															
7	L2	All MCs	206	18.5	206	18.5	0.346	9.7	LOS A	4.5	32.3	0.33	0.58	0.33	14.5
8	T1	All MCs	60	2.0	60	2.0	0.346	24.3	LOS B	4.5	32.3	0.39	0.60	0.39	13.3
9	R2	All MCs	34	2.0	34	2.0	0.185	54.4	LOS D	1.8	12.8	0.97	0.70	0.97	23.7
Approach			300	13.3	300	13.3	0.346	17.7	LOS B	4.5	32.3	0.41	0.60	0.41	18.3
West: Alexandra Avenue (W)															
10	L2	All MCs	227	2.0	227	2.0	*0.875	44.0	LOS D	10.5	74.9	0.99	1.01	1.26	25.7
11	T1	All MCs	74	2.0	74	2.0	0.183	35.2	LOS C	3.0	21.6	0.80	0.62	0.80	28.6
Approach			300	2.0	300	2.0	0.875	41.8	LOS C	10.5	74.9	0.94	0.91	1.14	26.4
All Vehicles			2336	3.5	2013	4.0	1.140	127.7	LOS F	35.1	249.7	0.90	1.43	1.71	9.3

Site Level of Service (LOS) Method: Delay (RTA NSW). Site LOS Method is specified in the Network Data dialog (Override Site Data tab).

Vehicle movement LOS values are based on average delay per movement.

Intersection and Approach LOS values are based on average delay for all vehicle movements.

Delay Model: SIDRA Standard (Control Delay: Geometric Delay is included).

Gap-Acceptance Capacity Formula: SIDRA Standard (Akçelik M3D).

HV (%) values are calculated for All Movement Classes of All Heavy Vehicle Model Designation.

Arrival Flows used in performance calculations are adjusted to include any Initial Queued Demand and Upstream Capacity Constraint effects.

* Critical Movement (Signal Timing)

Pedestrian Movement Performance (CCG)											
Mov ID	Crossing	Dem. Flow ped/h	Aver. Delay sec	Level of Service	AVERAGE BACK OF QUEUE [Ped Dist]		Prop. Que	Eff. Stop Rate	Travel Time sec	Travel Dist. m	Aver. Speed m/sec
Site: 14AM [HAW_RAI_23_14AM_DL]											
South: Hawkesbury Road (S)											
P1	Full	726	50.7	LOS E	2.2	2.2	0.97	0.97	204.5	200.0	0.98
East: Railway Parade											
P2	Full	2737	55.5	LOS E	9.1	9.1	1.07	1.07	209.3	200.0	0.96
North: Hawkesbury Road (N)											
P3	Full	726	50.7	LOS E	2.2	2.2	0.97	0.97	204.5	200.0	0.98
All Pedestrians		4189	53.8	LOS E	9.1	9.1	1.04	1.04	207.7	200.0	0.96
Site: 13AM [HAW_ALE_23_13AM_DL]											

South: Hawkesbury Road (S)											
P1	Full	1461	52.4	LOS E	4.6	4.6	1.01	1.01	206.2	200.0	0.97
East: Alexandra Avenue (E)											
P2	Full	2641	55.2	LOS E	8.8	8.8	1.06	1.06	209.1	200.0	0.96
West: Alexandra Avenue (W)											
P4	Full	173	49.5	LOS E	0.5	0.5	0.95	0.95	203.4	200.0	0.98
All Pedestrians		4275	54.0	LOS E	8.8	8.8	1.04	1.04	207.9	200.0	0.96

Level of Service (LOS) Method: SIDRA Pedestrian LOS Method (Based on Average Delay)
 Pedestrian movement LOS values are based on average delay per pedestrian movement.
 Intersection LOS value for Pedestrians is based on average delay for all pedestrian movements.

MOVEMENT SUMMARY

Site: 12AM [HAW_PRI_23_12AM_DL (Site Folder: Network 1)]

Output produced by SIDRA INTERSECTION Version: 9.1.4.221

Network: N101 [Network 1 - AM (Network Folder: Base Year_DL)]

TCS 1583 SS 44 7:30 AM - 8:30 AM

Site Category: Base Year

Signals - EQUISAT (Fixed-Time/SCATS) Coordinated Cycle Time = 111 seconds (Site User-Given Phase Times)

Vehicle Movement Performance															
Mov ID	Turn	Mov Class	Demand Flows		Arrival Flows		Deg. Satn	Aver. Delay	Level of Service	95% Back Of Queue		Prop. Que	Eff. Stop Rate	Aver. No. of Cycles	Aver. Speed
			[Total	HV]	[Total	HV]				[Veh.	Dist]				
			veh/h	%	veh/h	%	v/c	sec		veh	m				
South: Hawkesbury Road (S)															
2	T1	All MCs	374	2.0	374	2.0	0.253	13.0	LOS A	6.9	49.4	0.56	0.50	0.56	18.8
3	R2	All MCs	80	2.0	80	2.0	* 0.253	21.1	LOS B	5.7	40.3	0.60	0.58	0.60	22.6
Approach			453	2.0	453	2.0	0.253	14.4	LOS A	6.9	49.4	0.57	0.51	0.57	19.7
East: Priddle Street															
4	L2	All MCs	1	0.0	1	0.0	0.001	26.1	LOS B	0.0	0.3	0.72	0.57	0.72	12.6
6	R2	All MCs	1	0.0	1	0.0	0.002	29.2	LOS C	0.0	0.3	0.68	0.56	0.68	11.6
Approach			2	0.0	2	0.0	0.002	27.7	LOS B	0.0	0.3	0.70	0.57	0.70	12.1
North: Hawkesbury Road (N)															
7	L2	All MCs	77	2.0	77	2.0	0.102	25.1	LOS B	2.5	18.1	0.65	0.67	0.65	20.9
8	T1	All MCs	89	2.0	89	2.0	* 0.104	18.6	LOS B	2.7	19.3	0.61	0.49	0.61	19.6
Approach			166	2.0	166	2.0	0.104	21.6	LOS B	2.7	19.3	0.63	0.57	0.63	20.3
All Vehicles			621	2.0	621	2.0	0.253	16.4	LOS B	6.9	49.4	0.58	0.53	0.58	19.9

Site Level of Service (LOS) Method: Delay (RTA NSW). Site LOS Method is specified in the Network Data dialog (Override Site Data tab).

Vehicle movement LOS values are based on average delay per movement.

Intersection and Approach LOS values are based on average delay for all vehicle movements.

Delay Model: SIDRA Standard (Control Delay: Geometric Delay is included).

Queue Model: SIDRA queue estimation methods are used for Back of Queue and Queue at Start of Green.

Gap-Acceptance Capacity Formula: SIDRA Standard (Akçelik M3D).

HV (%) values are calculated for All Movement Classes of All Heavy Vehicle Model Designation.

Arrival Flows used in performance calculations are adjusted to include any Initial Queued Demand and Upstream Capacity Constraint effects.

* Critical Movement (Signal Timing)

Pedestrian Movement Performance											
Mov ID	Crossing	Dem. Flow ped/h	Aver. Delay sec	Level of Service	AVERAGE BACK OF QUEUE [Ped Dist]		Prop. Que	Eff. Stop Rate	Travel Time sec	Travel Dist. m	Aver. Speed m/sec
South: Hawkesbury Road (S)											
P1	Full	211	50.1	LOS E	0.6	0.6	0.95	0.95	203.9	200.0	0.98
East: Priddle Street											
P2	Full	211	50.1	LOS E	0.6	0.6	0.95	0.95	203.9	200.0	0.98
North: Hawkesbury Road (N)											
P3	Full	211	50.1	LOS E	0.6	0.6	0.95	0.95	203.9	200.0	0.98
All Pedestrians		632	50.1	LOS E	0.6	0.6	0.95	0.95	203.9	200.0	0.98

Level of Service (LOS) Method: SIDRA Pedestrian LOS Method (Based on Average Delay)
 Pedestrian movement LOS values are based on average delay per pedestrian movement.
 Intersection LOS value for Pedestrians is based on average delay for all pedestrian movements.

SIDRA INTERSECTION 9.1 | Copyright © 2000-2023 Akcelik and Associates Pty Ltd | sidrasolutions.com

Organisation: SCT CONSULTING PTY LTD | Licence: NETWORK / 1PC | Processed: Thursday, 19 October 2023 11:47:03 AM

Project: S:\Projects\SCT_00410_Cumberland Westmead Sth Transport Study\3. Technical Work Area\1. Network Optimisation\SCT_00410_Cumberland Westmead Sth_SIDRA_v0.5_upg1_sg.sip9

MOVEMENT SUMMARY

Site: 22AM [HAW_NOL_23_22AM_DL (Site Folder: Network 1)]

Output produced by SIDRA INTERSECTION Version: 9.1.4.221

Network: N101 [Network 1 - AM (Network Folder: Base Year_DL)]

Hawkesbury Road and Nolan Crescent
7:30 AM to 8:30 AM base year demand
Site Category: Base Year
Give-Way (Two-Way)

Vehicle Movement Performance															
Mov ID	Turn	Mov Class	Demand Flows [Total HV]		Arrival Flows [Total HV]		Deg. Satn	Aver. Delay	Level of Service	95% Back Of Queue [Veh. Dist]		Prop. Que	Eff. Stop Rate	Aver. No. of Cycles	Aver. Speed
			veh/h	%	veh/h	%	v/c	sec		veh	m				km/h
South: Hawkesbury Road (S)															
1	L2	All MCs	1	0.0	1	0.0	0.001	4.6	LOS A	0.0	0.0	0.00	0.53	0.00	42.6
2	T1	All MCs	512	2.0	512	2.0	0.267	0.0	LOS A	0.0	0.0	0.00	0.00	0.00	49.8
Approach			513	2.0	513	2.0	0.267	0.0	NA	0.0	0.0	0.00	0.00	0.00	49.8
North: Hawkesbury Road (N)															
8	T1	All MCs	385	2.0	385	2.0	0.197	0.0	LOS A	0.0	0.0	0.00	0.00	0.00	49.8
9	R2	All MCs	1	0.0	1	0.0	0.001	7.0	LOS A	0.0	0.0	0.49	0.56	0.49	39.2
Approach			386	2.0	386	2.0	0.197	0.0	NA	0.0	0.0	0.00	0.00	0.00	49.8
West: Nolan Crescent															
10	L2	All MCs	1	0.0	1	0.0	0.005	8.6	LOS A	0.0	0.1	0.58	0.66	0.58	35.4
12	R2	All MCs	1	0.0	1	0.0	0.005	11.0	LOS A	0.0	0.1	0.58	0.66	0.58	38.0
Approach			2	0.0	2	0.0	0.005	9.8	LOS A	0.0	0.1	0.58	0.66	0.58	36.9
All Vehicles			901	2.0	901	2.0	0.267	0.1	NA	0.0	0.1	0.00	0.00	0.00	49.7

Site Level of Service (LOS) Method: Delay (RTA NSW). Site LOS Method is specified in the Network Data dialog (Override Site Data tab).

Vehicle movement LOS values are based on average delay per movement.

Minor Road Approach LOS values are based on average delay for all vehicle movements.

NA (TWSC): Level of Service is not defined for major road approaches or the intersection as a whole for Two-Way Sign Control (HCM LOS rule).

Two-Way Sign Control Capacity Model: SIDRA Standard.

Delay Model: SIDRA Standard (Control Delay: Geometric Delay is included).

Queue Model: SIDRA queue estimation methods are used for Back of Queue and Queue at Start of Gap.

Gap-Acceptance Capacity Formula: SIDRA Standard (Akçelik M3D).

HV (%) values are calculated for All Movement Classes of All Heavy Vehicle Model Designation.

Arrival Flows used in performance calculations are adjusted to include any Initial Queued Demand and Upstream Capacity Constraint effects.

SIDRA INTERSECTION 9.1 | Copyright © 2000-2023 Akcelik and Associates Pty Ltd | sidrasolutions.com

Organisation: SCT CONSULTING PTY LTD | Licence: NETWORK / 1PC | Processed: Thursday, 19 October 2023 11:47:03 AM

Project: S:\Projects\SCT_00410_Cumberland Westmead Sth Transport Study\3. Technical Work Area\1. Network Optimisation\SCT_00410_Cumberland Westmead Sth_SIDRA_v0.5_upg1_sg.sip9

MOVEMENT SUMMARY

Site: 15AM [HAW_CHU_23_15AM_DL (Site Folder: Network 1)]

Output produced by SIDRA INTERSECTION Version: 9.1.4.221

Network: N101 [Network 1 - AM (Network Folder: Base Year_DL)]

Hawkesbury Road and Church Avenue
 7:30 AM to 8:30 AM base year demand
 Site Category: Base Year
 Give-Way (Two-Way)

Vehicle Movement Performance															
Mov ID	Turn	Mov Class	Demand Flows [Total HV]		Arrival Flows [Total HV]		Deg. Satn	Aver. Delay	Level of Service	95% Back Of Queue [Veh. Dist]		Prop. Que	Eff. Stop Rate	Aver. No. of Cycles	Aver. Speed
			veh/h	%	veh/h	%	v/c	sec		veh	m				km/h
South: Hawkesbury Road (S)															
1	L2	All MCs	1	0.0	1	0.0	0.252	4.6	LOS A	0.0	0.0	0.00	0.00	0.00	47.8
2	T1	All MCs	501	2.0	501	2.0	0.252	0.0	LOS A	0.0	0.0	0.00	0.00	0.00	49.8
Approach			502	2.0	502	2.0	0.252	0.0	NA	0.0	0.0	0.00	0.00	0.00	49.8
North: Hawkesbury Road (N)															
8	T1	All MCs	147	2.0	147	2.0	0.076	0.0	LOS A	0.0	0.0	0.00	0.00	0.00	49.7
9	R2	All MCs	1	0.0	1	0.0	0.001	5.9	LOS A	0.0	0.0	0.50	0.49	0.50	40.8
Approach			148	2.0	148	2.0	0.076	0.0	NA	0.0	0.0	0.00	0.00	0.00	49.2
West: Church Avenue															
10	L2	All MCs	1	0.0	1	0.0	0.004	7.6	LOS A	0.0	0.1	0.51	0.63	0.51	39.7
12	R2	All MCs	1	0.0	1	0.0	0.004	9.5	LOS A	0.0	0.1	0.51	0.63	0.51	39.7
Approach			2	0.0	2	0.0	0.004	8.5	LOS A	0.0	0.1	0.51	0.63	0.51	39.7
All Vehicles			652	2.0	652	2.0	0.252	0.1	NA	0.0	0.1	0.00	0.00	0.00	49.6

Site Level of Service (LOS) Method: Delay (RTA NSW). Site LOS Method is specified in the Network Data dialog (Override Site Data tab).

Vehicle movement LOS values are based on average delay per movement.

Minor Road Approach LOS values are based on average delay for all vehicle movements.

NA (TWSC): Level of Service is not defined for major road approaches or the intersection as a whole for Two-Way Sign Control (HCM LOS rule).

Two-Way Sign Control Capacity Model: SIDRA Standard.

Delay Model: SIDRA Standard (Control Delay: Geometric Delay is included).

Queue Model: SIDRA queue estimation methods are used for Back of Queue and Queue at Start of Gap.

Gap-Acceptance Capacity Formula: SIDRA Standard (Akçelik M3D).

HV (%) values are calculated for All Movement Classes of All Heavy Vehicle Model Designation.

Arrival Flows used in performance calculations are adjusted to include any Initial Queued Demand and Upstream Capacity Constraint effects.

SIDRA INTERSECTION 9.1 | Copyright © 2000-2023 Akcelik and Associates Pty Ltd | sidrasolutions.com

Organisation: SCT CONSULTING PTY LTD | Licence: NETWORK / 1PC | Processed: Thursday, 19 October 2023 11:47:03 AM

Project: S:\Projects\SCT_00410_Cumberland Westmead Sth Transport Study\3. Technical Work Area\1. Network Optimisation\SCT_00410_Cumberland Westmead Sth_SIDRA_v0.5_upg1_sg.sip9

MOVEMENT SUMMARY

Site: 20AM [HAW_AUS_23_20AM_DL (Site Folder: Network 1)]

Output produced by SIDRA INTERSECTION Version: 9.1.4.221

Network: N101 [Network 1 - AM (Network Folder: Base Year_DL)]

Hawkesbury Road and Church Avenue
7:30 AM to 8:30 AM base year demand
Site Category: Base Year
Give-Way (Two-Way)

Vehicle Movement Performance															
Mov ID	Turn	Mov Class	Demand Flows [Total HV]		Arrival Flows [Total HV]		Deg. Satn	Aver. Delay	Level of Service	95% Back Of Queue [Veh. Dist]		Prop. Que	Eff. Stop Rate	Aver. No. of Cycles	Aver. Speed
			veh/h	%	veh/h	%	v/c	sec		veh	m				km/h
South: Hawkesbury Road (S)															
1	L2	All MCs	1	0.0	1	0.0	0.229	4.6	LOS A	0.0	0.0	0.00	0.22	0.00	47.0
2	T1	All MCs	452	2.0	452	2.0	0.229	1.1	LOS A	0.0	0.0	0.00	0.22	0.00	41.6
Approach			453	2.0	453	2.0	0.229	1.1	NA	0.0	0.0	0.00	0.22	0.00	41.7
North: Hawkesbury Road (N)															
8	T1	All MCs	204	2.0	204	2.0	0.104	0.0	LOS A	0.0	0.1	0.01	0.00	0.01	39.8
9	R2	All MCs	1	0.0	1	0.0	0.104	3.8	LOS A	0.0	0.1	0.01	0.00	0.01	46.0
Approach			205	2.0	205	2.0	0.104	0.0	NA	0.0	0.1	0.01	0.00	0.01	40.0
West: Austral Avenue															
10	L2	All MCs	1	0.0	1	0.0	0.002	5.7	LOS A	0.0	0.0	0.39	0.54	0.39	43.7
12	R2	All MCs	1	0.0	1	0.0	0.002	5.7	LOS A	0.0	0.0	0.39	0.54	0.39	43.7
Approach			2	0.0	2	0.0	0.002	5.7	LOS A	0.0	0.0	0.39	0.54	0.39	43.7
All Vehicles			660	2.0	660	2.0	0.229	0.8	NA	0.0	0.1	0.00	0.16	0.00	41.0

Site Level of Service (LOS) Method: Delay (RTA NSW). Site LOS Method is specified in the Network Data dialog (Override Site Data tab).

Vehicle movement LOS values are based on average delay per movement.

Minor Road Approach LOS values are based on average delay for all vehicle movements.

NA (TWSC): Level of Service is not defined for major road approaches or the intersection as a whole for Two-Way Sign Control (HCM LOS rule).

Two-Way Sign Control Capacity Model: SIDRA Standard.

Delay Model: SIDRA Standard (Control Delay: Geometric Delay is included).

Queue Model: SIDRA queue estimation methods are used for Back of Queue and Queue at Start of Gap.

Gap-Acceptance Capacity Formula: SIDRA Standard (Akçelik M3D).

HV (%) values are calculated for All Movement Classes of All Heavy Vehicle Model Designation.

Arrival Flows used in performance calculations are adjusted to include any Initial Queued Demand and Upstream Capacity Constraint effects.

SIDRA INTERSECTION 9.1 | Copyright © 2000-2023 Akcelik and Associates Pty Ltd | sidrasolutions.com

Organisation: SCT CONSULTING PTY LTD | Licence: NETWORK / 1PC | Processed: Thursday, 19 October 2023 11:47:03 AM

Project: S:\Projects\SCT_00410_Cumberland Westmead Sth Transport Study\3. Technical Work Area\1. Network Optimisation\SCT_00410_Cumberland Westmead Sth_SIDRA_v0.5_upg1_sg.sip9

MOVEMENT SUMMARY

Site: 18AM [ALE_HAS_23_18AM_DL (Site Folder: Network 1)]

Output produced by SIDRA INTERSECTION Version: 9.1.4.221

Network: N101 [Network 1 - AM (Network Folder: Base Year_DL)]

Alexandra Avenue and Hassall Street (8:00 to 9:00 AM)

TCS 3894 SS 44

Site Category: Base Year

Signals - EQUISAT (Fixed-Time/SCATS) Coordinated Cycle Time = 110 seconds (Network Practical Cycle Time)

Vehicle Movement Performance															
Mov ID	Turn	Mov Class	Demand Flows [Total HV]		Arrival Flows [Total HV]		Deg. Satn	Aver. Delay	Level of Service	95% Back Of Queue [Veh. Dist]		Prop. Que	Eff. Stop Rate	Aver. No. of Cycles	Aver. Speed
			veh/h	%	veh/h	%	v/c	sec		veh	m				km/h
South: Hassall Street															
1	L2	All MCs	616	2.0	616	2.0	* 1.401	432.6	LOS F	100.4	715.2	1.00	1.98	3.44	0.8
3	R2	All MCs	369	2.0	369	2.0	1.338	384.4	LOS F	55.8	397.4	1.00	1.84	3.23	5.2
Approach			985	2.0	985	2.0	1.401	414.5	LOS F	100.4	715.2	1.00	1.93	3.36	2.3
East: Alexandra Avenue (E)															
4	L2	All MCs	59	2.0	59	2.0	0.039	7.2	LOS A	0.5	3.7	0.18	0.61	0.18	47.0
5	T1	All MCs	648	2.0	648	2.0	* 1.410	418.1	LOS F	105.7	752.4	1.00	2.70	3.47	4.1
Approach			707	2.0	707	2.0	1.410	383.6	LOS F	105.7	752.4	0.93	2.53	3.20	4.5
West: Alexandra Avenue (W)															
11	T1	All MCs	288	14.4	288	14.4	0.168	23.4	LOS B	7.2	56.3	0.77	0.52	0.77	37.7
12	R2	All MCs	1	0.0	1	0.0	0.168	101.2	LOS F	7.2	56.3	1.00	0.56	1.00	17.3
Approach			289	14.4	289	14.4	0.168	23.7	LOS B	7.2	56.3	0.78	0.52	0.78	37.6
All Vehicles			1981	3.8	1981	3.8	1.410	346.5	LOS F	105.7	752.4	0.94	1.94	2.93	4.0

Site Level of Service (LOS) Method: Delay (RTA NSW). Site LOS Method is specified in the Network Data dialog (Override Site Data tab).

Vehicle movement LOS values are based on average delay per movement.

Intersection and Approach LOS values are based on average delay for all vehicle movements.

Delay Model: SIDRA Standard (Control Delay: Geometric Delay is included).

Queue Model: SIDRA queue estimation methods are used for Back of Queue and Queue at Start of Green.

Gap-Acceptance Capacity Formula: SIDRA Standard (Akçelik M3D).

HV (%) values are calculated for All Movement Classes of All Heavy Vehicle Model Designation.

Arrival Flows used in performance calculations are adjusted to include any Initial Queued Demand and Upstream Capacity Constraint effects.

* Critical Movement (Signal Timing)

Pedestrian Movement Performance											
Mov ID	Crossing	Dem. Flow ped/h	Aver. Delay sec	Level of Service	AVERAGE BACK OF QUEUE [Ped Dist]		Prop. Que	Eff. Stop Rate	Travel Time sec	Travel Dist. m	Aver. Speed m/sec
South: Hassall Street											
P1	Full	446	50.1	LOS E	1.3	1.3	0.96	0.96	203.9	200.0	0.98
West: Alexandra Avenue (W)											
P4	Full	221	49.6	LOS E	0.7	0.7	0.95	0.95	203.5	200.0	0.98
All Pedestrians		667	49.9	LOS E	1.3	1.3	0.96	0.96	203.8	200.0	0.98

Level of Service (LOS) Method: SIDRA Pedestrian LOS Method (Based on Average Delay)
 Pedestrian movement LOS values are based on average delay per pedestrian movement.
 Intersection LOS value for Pedestrians is based on average delay for all pedestrian movements.

CCG MOVEMENT SUMMARY

Common Control Group: CCG1 [TCS 1571]

Output produced by SIDRA INTERSECTION Version: 9.1.4.221

Network: N101 [Network 1 - PM (Network Folder: Base Year_DL)]

EQUISAT (Fixed-Time/SCATS) Coordinated Cycle Time = 110 seconds (Network Practical Cycle Time)

Vehicle Movement Performance (CCG)															
Mov ID	Turn	Mov Class	Demand Flows [Total HV]		Arrival Flows [Total HV]		Deg. Satn	Aver. Delay	Level of Service	Aver. Back Of Queue [Veh. Dist]		Prop. Que	Eff. Stop Rate	Aver. No. of Cycles	Aver. Speed
			veh/h	%	veh/h	%	v/c	sec		veh	m				km/h
Site: 14PM [HAW_RAI_23_14PM_DL]															
South: Hawkesbury Road (S)															
2	T1	All MCs	470	2.0	441	2.0	0.334	3.4	LOS A	2.4	17.0	0.18	0.34	0.18	35.6
3	R2	All MCs	534	2.0	500	2.0	0.632	20.6	LOS B	7.7	55.0	0.68	0.91	0.68	30.3
Approach			1003	2.0	941	2.0	0.632	12.5	LOS A	7.7	55.0	0.45	0.64	0.45	31.2
East: Railway Parade															
4	L2	All MCs	105	2.0	105	2.0	0.162	18.6	LOS B	2.2	15.5	0.67	0.58	0.67	30.1
6	R2	All MCs	16	2.0	16	2.0	0.057	46.3	LOS D	0.4	3.2	0.88	0.67	0.88	23.7
Approach			121	2.0	121	2.0	0.162	22.2	LOS B	2.2	15.5	0.70	0.59	0.70	28.9
North: Hawkesbury Road (N)															
7	L2	All MCs	123	2.0	123	2.0	0.385	42.0	LOS C	4.2	34.6	0.88	0.77	0.88	24.9
8	T1	All MCs	450	8.4	450	8.4	0.625	37.9	LOS C	7.3	52.2	0.92	0.79	0.93	10.1
Approach			573	7.1	573	7.1	0.625	38.8	LOS C	7.3	52.2	0.91	0.78	0.92	15.5
All Vehicles			1697	3.7	1635	3.8	0.632	22.4	LOS B	7.7	55.0	0.63	0.69	0.63	25.0
Site: 13PM [HAW_ALE_23_13PM_DL]															
South: Hawkesbury Road (S)															
1	L2	All MCs	1	0.0	1	0.0	0.991	93.7	LOS F	15.0	106.7	1.00	1.37	1.59	19.7
2	T1	All MCs	489	2.0	489	2.0	*0.991	90.5	LOS F	15.0	106.7	1.00	1.37	1.65	6.7
Approach			490	2.0	490	2.0	0.991	90.5	LOS F	15.0	106.7	1.00	1.37	1.65	6.8
East: Alexandra Avenue (E)															
4	L2	All MCs	2	2.2	2	2.2	1.131	184.1	LOS F	21.5	153.0	1.00	1.87	2.14	3.4
5	T1	All MCs	914	2.0	770	2.0	*1.131	176.0	LOS F	21.5	153.0	1.00	1.87	2.14	12.4
6	R2	All MCs	385	2.0	324	2.0	1.000	103.1	LOS F	17.1	121.6	1.00	1.31	1.67	5.5

Approach			1301	2.0	1096	2.0	1.131	154.4	LOS F	21.5	153.0	1.00	1.71	2.00	11.2
North: Hawkesbury Road (N)															
7	L2	All MCs	312	11.3	312	11.3	0.811	48.5	LOS D	7.7	55.0	0.99	0.89	1.11	4.6
8	T1	All MCs	183	2.0	183	2.0	0.811	38.5	LOS C	7.7	55.0	0.91	0.92	0.96	6.2
9	R2	All MCs	60	2.0	60	2.0	* 0.771	46.7	LOS D	6.1	43.2	0.89	0.92	0.93	28.9
Approach			555	7.2	555	7.2	0.811	45.0	LOS D	7.7	55.0	0.95	0.91	1.04	9.1
West: Alexandra Avenue (W)															
10	L2	All MCs	130	2.0	130	2.0	* 0.403	25.2	LOS B	2.3	16.3	0.87	0.77	0.87	32.4
11	T1	All MCs	36	1.9	36	1.9	0.092	38.6	LOS C	1.0	6.8	0.85	0.63	0.85	27.3
Approach			166	2.0	166	2.0	0.403	28.1	LOS B	2.3	16.3	0.87	0.74	0.87	31.1
All Vehicles			2511	3.2	2307	3.4	1.131	105.4	LOS F	21.5	153.0	0.98	1.37	1.62	11.0

Site Level of Service (LOS) Method: Delay (RTA NSW). Site LOS Method is specified in the Network Data dialog (Override Site Data tab).

Vehicle movement LOS values are based on average delay per movement.

Intersection and Approach LOS values are based on average delay for all vehicle movements.

Delay Model: SIDRA Standard (Control Delay: Geometric Delay is included).

Gap-Acceptance Capacity Formula: SIDRA Standard (Akçelik M3D).

HV (%) values are calculated for All Movement Classes of All Heavy Vehicle Model Designation.

Arrival Flows used in performance calculations are adjusted to include any Initial Queued Demand and Upstream Capacity Constraint effects.

* Critical Movement (Signal Timing)

Pedestrian Movement Performance (CCG)												
Mov ID	Crossing	Dem. Flow ped/h	Aver. Delay sec	Level of Service	AVERAGE BACK OF QUEUE [Ped Dist]		Prop. Que	Eff. Stop Rate	Travel Time sec	Travel Dist. m	Aver. Speed m/sec	
Site: 14PM [HAW_RAI_23_14PM_DL]												
South: Hawkesbury Road (S)												
P1	Full	676	50.6	LOS E	2.1	2.1	0.97	0.97	204.4	200.0	0.98	
East: Railway Parade												
P2	Full	2544	55.0	LOS E	8.4	8.4	1.06	1.06	208.8	200.0	0.96	
North: Hawkesbury Road (N)												
P3	Full	713	50.7	LOS E	2.2	2.2	0.97	0.97	204.5	200.0	0.98	
All Pedestrians		3933	53.5	LOS E	8.4	8.4	1.03	1.03	207.3	200.0	0.96	
Site: 13PM [HAW_ALE_23_13PM_DL]												

South: Hawkesbury Road (S)											
P1	Full	1353	52.1	LOS E	4.2	4.2	1.00	1.00	205.9	200.0	0.97
East: Alexandra Avenue (E)											
P2	Full	3322	57.1	LOS E	11.4	11.4	1.10	1.10	210.9	200.0	0.95
West: Alexandra Avenue (W)											
P4	Full	183	49.5	LOS E	0.5	0.5	0.95	0.95	203.4	200.0	0.98
All Pedestrians		4858	55.4	LOS E	11.4	11.4	1.07	1.07	209.2	200.0	0.96

Level of Service (LOS) Method: SIDRA Pedestrian LOS Method (Based on Average Delay)
 Pedestrian movement LOS values are based on average delay per pedestrian movement.
 Intersection LOS value for Pedestrians is based on average delay for all pedestrian movements.

SIDRA INTERSECTION 9.1 | Copyright © 2000-2023 Akcelik and Associates Pty Ltd | sidrasolutions.com

Organisation: SCT CONSULTING PTY LTD | Licence: NETWORK / 1PC | Processed: Tuesday, 17 October 2023 12:53:49 PM

Project: S:\Projects\SCT_00410_Cumberland Westmead Sth Transport Study\3. Technical Work Area\1. Network Optimisation\SCT_00410_Cumberland Westmead Sth_SIDRA_v0.5_upg1_sg.sip9

MOVEMENT SUMMARY

Site: 12PM [HAW_PRI_23_12PM_DL (Site Folder: Network 1)]

Output produced by SIDRA INTERSECTION Version: 9.1.4.221

Network: N101 [Network 1 - PM (Network Folder: Base Year_DL)]

TCS 1583 SS 44

5:00 PM to 6:00 PM Base year demand

Site Category: Base Year

Signals - EQUISAT (Fixed-Time/SCATS) Isolated Cycle Time = 66 seconds (Site User-Given Phase Times)

Vehicle Movement Performance															
Mov ID	Turn	Mov Class	Demand Flows [Total HV]		Arrival Flows [Total HV]		Deg. Satn	Aver. Delay	Level of Service	Aver. Back Of Queue [Veh. Dist]		Prop. Que	Eff. Stop Rate	Aver. No. of Cycles	Aver. Speed
			veh/h	%	veh/h	%	v/c	sec		veh	m				km/h
South: Hawkesbury Road (S)															
2	T1	All MCs	210	2.0	210	2.0	0.153	2.9	LOS A	1.3	8.9	0.33	0.27	0.33	38.6
3	R2	All MCs	125	2.0	125	2.0	* 2.306	1222.1	LOS F	17.1	122.0	1.00	2.81	8.79	0.7
Approach			335	2.0	335	2.0	2.306	458.7	LOS F	17.1	122.0	0.58	1.22	3.49	1.4
East: Priddle Street															
4	L2	All MCs	1	0.0	1	0.0	0.002	24.8	LOS B	0.0	0.1	0.77	0.58	0.77	14.0
6	R2	All MCs	1	0.0	1	0.0	0.003	28.4	LOS B	0.0	0.1	0.83	0.59	0.83	12.6
Approach			2	0.0	2	0.0	0.003	26.6	LOS B	0.0	0.1	0.80	0.58	0.80	13.2
North: Hawkesbury Road (N)															
7	L2	All MCs	162	2.0	162	2.0	0.144	10.6	LOS A	1.4	9.7	0.46	0.66	0.46	32.3
8	T1	All MCs	222	2.0	221	2.0	* 0.193	6.2	LOS A	1.9	13.7	0.47	0.40	0.47	34.9
Approach			383	2.0	383	2.0	0.193	8.1	LOS A	1.9	13.7	0.47	0.51	0.47	33.4
All Vehicles			721	2.0	720	2.0	2.306	217.8	LOS F	17.1	122.0	0.52	0.84	1.87	3.3

Site Level of Service (LOS) Method: Delay (RTA NSW). Site LOS Method is specified in the Network Data dialog (Override Site Data tab).

Vehicle movement LOS values are based on average delay per movement.

Intersection and Approach LOS values are based on average delay for all vehicle movements.

Delay Model: SIDRA Standard (Control Delay: Geometric Delay is included).

Queue Model: SIDRA queue estimation methods are used for Back of Queue and Queue at Start of Green.

Gap-Acceptance Capacity Formula: SIDRA Standard (Akçelik M3D).

HV (%) values are calculated for All Movement Classes of All Heavy Vehicle Model Designation.

Arrival Flows used in performance calculations are adjusted to include any Initial Queued Demand and Upstream Capacity Constraint effects.

* Critical Movement (Signal Timing)

Pedestrian Movement Performance											
Mov ID	Crossing	Dem. Flow ped/h	Aver. Delay sec	Level of Service	AVERAGE BACK OF QUEUE [Ped Dist]		Prop. Que	Eff. Stop Rate	Travel Time sec	Travel Dist. m	Aver. Speed m/sec
South: Hawkesbury Road (S)											
P1	Full	211	27.5	LOS C	0.4	0.4	0.92	0.92	181.4	200.0	1.10
East: Priddle Street											
P2	Full	211	27.5	LOS C	0.4	0.4	0.92	0.92	181.4	200.0	1.10
North: Hawkesbury Road (N)											
P3	Full	211	27.5	LOS C	0.4	0.4	0.92	0.92	181.4	200.0	1.10
All Pedestrians		632	27.5	LOS C	0.4	0.4	0.92	0.92	181.4	200.0	1.10

Level of Service (LOS) Method: SIDRA Pedestrian LOS Method (Based on Average Delay)
 Pedestrian movement LOS values are based on average delay per pedestrian movement.
 Intersection LOS value for Pedestrians is based on average delay for all pedestrian movements.

SIDRA INTERSECTION 9.1 | Copyright © 2000-2023 Akcelik and Associates Pty Ltd | sidrasolutions.com

Organisation: SCT CONSULTING PTY LTD | Licence: NETWORK / 1PC | Processed: Tuesday, 17 October 2023 12:53:49 PM

Project: S:\Projects\SCT_00410_Cumberland Westmead Sth Transport Study\3. Technical Work Area\1. Network Optimisation\SCT_00410_Cumberland Westmead Sth_SIDRA_v0.5_upg1_sg.sip9

MOVEMENT SUMMARY

Site: 22PM [HAW_NOL_23_22PM_DL (Site Folder: Network 1)]

Output produced by SIDRA INTERSECTION Version: 9.1.4.221

Network: N101 [Network 1 - PM (Network Folder: Base Year_DL)]

Hawkesbury Road and Nolan Crescent
 5:00 PM to 6:00 PM Base year demand
 Site Category: Base Year
 Give-Way (Two-Way)

Vehicle Movement Performance															
Mov ID	Turn	Mov Class	Demand Flows [Total]	Flows HV]	Arrival Flows [Total]	Flows HV]	Deg. Satn	Aver. Delay	Level of Service	Aver. Back Of Queue [Veh.]	Dist]	Prop. Que	Eff. Stop Rate	Aver. No. of Cycles	Aver. Speed
			veh/h	%	veh/h	%	v/c	sec		veh	m				km/h
South: Hawkesbury Road (S)															
1	L2	All MCs	1	0.0	1	0.0	0.001	4.6	LOS A	0.0	0.0	0.00	0.53	0.00	42.6
2	T1	All MCs	373	2.0	373	2.0	0.195	0.0	LOS A	0.0	0.0	0.00	0.00	0.00	49.9
Approach			374	2.0	374	2.0	0.195	0.0	NA	0.0	0.0	0.00	0.00	0.00	49.9
North: Hawkesbury Road (N)															
8	T1	All MCs	447	2.0	447	2.0	0.230	0.0	LOS A	0.0	0.0	0.00	0.00	0.00	49.9
9	R2	All MCs	1	0.0	1	0.0	0.001	6.1	LOS A	0.0	0.0	0.42	0.53	0.42	40.1
Approach			448	2.0	448	2.0	0.230	0.0	NA	0.0	0.0	0.00	0.00	0.00	49.9
West: Nolan Crescent															
10	L2	All MCs	1	0.0	1	0.0	0.003	5.8	LOS A	0.0	0.0	0.49	0.56	0.49	38.4
12	R2	All MCs	1	0.0	1	0.0	0.003	8.7	LOS A	0.0	0.0	0.49	0.56	0.49	40.1
Approach			2	0.0	2	0.0	0.003	7.2	LOS A	0.0	0.0	0.49	0.56	0.49	39.4
All Vehicles			824	2.0	824	2.0	0.230	0.1	NA	0.0	0.0	0.00	0.00	0.00	49.8

Site Level of Service (LOS) Method: Delay (RTA NSW). Site LOS Method is specified in the Network Data dialog (Override Site Data tab).

Vehicle movement LOS values are based on average delay per movement.

Minor Road Approach LOS values are based on average delay for all vehicle movements.

NA (TWSC): Level of Service is not defined for major road approaches or the intersection as a whole for Two-Way Sign Control (HCM LOS rule).

Two-Way Sign Control Capacity Model: SIDRA Standard.

Delay Model: SIDRA Standard (Control Delay: Geometric Delay is included).

Queue Model: SIDRA queue estimation methods are used for Back of Queue and Queue at Start of Gap.

Gap-Acceptance Capacity Formula: SIDRA Standard (Akçelik M3D).

HV (%) values are calculated for All Movement Classes of All Heavy Vehicle Model Designation.

Arrival Flows used in performance calculations are adjusted to include any Initial Queued Demand and Upstream Capacity Constraint effects.

SIDRA INTERSECTION 9.1 | Copyright © 2000-2023 Akcelik and Associates Pty Ltd | sidrasolutions.com

Organisation: SCT CONSULTING PTY LTD | Licence: NETWORK / 1PC | Processed: Tuesday, 17 October 2023 12:53:49 PM

Project: S:\Projects\SCT_00410_Cumberland Westmead Sth Transport Study\3. Technical Work Area\1. Network Optimisation\SCT_00410_Cumberland Westmead Sth_SIDRA_v0.5_upg1_sg.sip9

MOVEMENT SUMMARY

Site: 15PM [HAW_CHU_23_15PM_DL (Site Folder: Network 1)]

Output produced by SIDRA INTERSECTION Version: 9.1.4.221

Network: N101 [Network 1 - PM (Network Folder: Base Year_DL)]

Hawkesbury Road and Church Avenue
 5:00 PM to 6:00 PM Base year demand
 Site Category: Base Year
 Give-Way (Two-Way)

Vehicle Movement Performance															
Mov ID	Turn	Mov Class	Demand Flows [Total HV]	Flows %	Arrival Flows [Total HV]	Flows %	Deg. Satn	Aver. Delay	Level of Service	Aver. Back Of Queue [Veh. Dist]	Prop. Que	Eff. Stop Rate	Aver. No. of Cycles	Aver. Speed	
			veh/h	%	veh/h	%	v/c	sec		veh	m			km/h	
South: Hawkesbury Road (S)															
1	L2	All MCs	1	0.0	1	0.0	0.176	4.6	LOS A	0.0	0.0	0.00	0.00	0.00	47.8
2	T1	All MCs	350	2.0	350	2.0	0.176	0.0	LOS A	0.0	0.0	0.00	0.00	0.00	49.9
Approach			351	2.0	351	2.0	0.176	0.0	NA	0.0	0.0	0.00	0.00	0.00	49.8
North: Hawkesbury Road (N)															
8	T1	All MCs	168	2.0	168	2.0	0.087	0.0	LOS A	0.0	0.0	0.00	0.00	0.00	50.0
9	R2	All MCs	1	0.0	1	0.0	0.001	5.4	LOS A	0.0	0.0	0.41	0.47	0.41	41.1
Approach			169	2.0	169	2.0	0.087	0.0	NA	0.0	0.0	0.00	0.00	0.00	49.5
West: Church Avenue															
10	L2	All MCs	1	0.0	1	0.0	0.002	5.4	LOS A	0.0	0.0	0.39	0.52	0.39	42.1
12	R2	All MCs	1	0.0	1	0.0	0.002	6.1	LOS A	0.0	0.0	0.39	0.52	0.39	42.1
Approach			2	0.0	2	0.0	0.002	5.8	LOS A	0.0	0.0	0.39	0.52	0.39	42.1
All Vehicles			522	2.0	522	2.0	0.176	0.1	NA	0.0	0.0	0.00	0.00	0.00	49.7

Site Level of Service (LOS) Method: Delay (RTA NSW). Site LOS Method is specified in the Network Data dialog (Override Site Data tab).

Vehicle movement LOS values are based on average delay per movement.

Minor Road Approach LOS values are based on average delay for all vehicle movements.

NA (TWSC): Level of Service is not defined for major road approaches or the intersection as a whole for Two-Way Sign Control (HCM LOS rule).

Two-Way Sign Control Capacity Model: SIDRA Standard.

Delay Model: SIDRA Standard (Control Delay: Geometric Delay is included).

Queue Model: SIDRA queue estimation methods are used for Back of Queue and Queue at Start of Gap.

Gap-Acceptance Capacity Formula: SIDRA Standard (Akçelik M3D).

HV (%) values are calculated for All Movement Classes of All Heavy Vehicle Model Designation.

Arrival Flows used in performance calculations are adjusted to include any Initial Queued Demand and Upstream Capacity Constraint effects.

SIDRA INTERSECTION 9.1 | Copyright © 2000-2023 Akcelik and Associates Pty Ltd | sidrasolutions.com

Organisation: SCT CONSULTING PTY LTD | Licence: NETWORK / 1PC | Processed: Tuesday, 17 October 2023 12:53:49 PM

Project: S:\Projects\SCT_00410_Cumberland Westmead Sth Transport Study\3. Technical Work Area\1. Network Optimisation\SCT_00410_Cumberland Westmead Sth_SIDRA_v0.5_upg1_sg.sip9

MOVEMENT SUMMARY

Site: 20PM [HAW_AUS_23_20PM_DL (Site Folder: Network 1)]

Output produced by SIDRA INTERSECTION Version: 9.1.4.221

Network: N101 [Network 1 - PM (Network Folder: Base Year_DL)]

Hawkesbury Road and Church Avenue
 5:00 PM to 6:00 PM Base year demand
 Site Category: Base Year
 Give-Way (Two-Way)

Vehicle Movement Performance															
Mov ID	Turn	Mov Class	Demand Flows [Total	Flows HV]	Arrival Flows [Total	Flows HV]	Deg. Satn	Aver. Delay	Level of Service	Aver. Back Of Queue [Veh.	Dist]	Prop. Que	Eff. Stop Rate	Aver. No. of Cycles	Aver. Speed
			veh/h	%	veh/h	%	v/c	sec		veh	m				km/h
South: Hawkesbury Road (S)															
1	L2	All MCs	1	0.0	1	0.0	0.170	4.6	LOS A	0.0	0.0	0.00	0.22	0.00	47.0
2	T1	All MCs	335	2.0	335	2.0	0.170	1.1	LOS A	0.0	0.0	0.00	0.22	0.00	41.6
Approach			336	2.0	336	2.0	0.170	1.1	NA	0.0	0.0	0.00	0.22	0.00	41.7
North: Hawkesbury Road (N)															
8	T1	All MCs	297	2.0	297	2.0	0.152	0.0	LOS A	0.0	0.0	0.00	0.00	0.00	39.9
9	R2	All MCs	1	0.0	1	0.0	0.152	3.6	LOS A	0.0	0.0	0.00	0.00	0.00	46.0
Approach			298	2.0	298	2.0	0.152	0.0	NA	0.0	0.0	0.00	0.00	0.00	40.0
West: Austral Avenue															
10	L2	All MCs	1	0.0	1	0.0	0.002	6.3	LOS A	0.0	0.0	0.39	0.55	0.39	43.7
12	R2	All MCs	1	0.0	1	0.0	0.002	6.0	LOS A	0.0	0.0	0.39	0.55	0.39	43.7
Approach			2	0.0	2	0.0	0.002	6.1	LOS A	0.0	0.0	0.39	0.55	0.39	43.7
All Vehicles			637	2.0	636	2.0	0.170	0.6	NA	0.0	0.0	0.00	0.12	0.00	40.7

Site Level of Service (LOS) Method: Delay (RTA NSW). Site LOS Method is specified in the Network Data dialog (Override Site Data tab).

Vehicle movement LOS values are based on average delay per movement.

Minor Road Approach LOS values are based on average delay for all vehicle movements.

NA (TWSC): Level of Service is not defined for major road approaches or the intersection as a whole for Two-Way Sign Control (HCM LOS rule).

Two-Way Sign Control Capacity Model: SIDRA Standard.

Delay Model: SIDRA Standard (Control Delay: Geometric Delay is included).

Queue Model: SIDRA queue estimation methods are used for Back of Queue and Queue at Start of Gap.

Gap-Acceptance Capacity Formula: SIDRA Standard (Akçelik M3D).

HV (%) values are calculated for All Movement Classes of All Heavy Vehicle Model Designation.

Arrival Flows used in performance calculations are adjusted to include any Initial Queued Demand and Upstream Capacity Constraint effects.

SIDRA INTERSECTION 9.1 | Copyright © 2000-2023 Akcelik and Associates Pty Ltd | sidrasolutions.com

Organisation: SCT CONSULTING PTY LTD | Licence: NETWORK / 1PC | Processed: Tuesday, 17 October 2023 12:53:49 PM

Project: S:\Projects\SCT_00410_Cumberland Westmead Sth Transport Study\3. Technical Work Area\1. Network Optimisation\SCT_00410_Cumberland Westmead Sth_SIDRA_v0.5_upg1_sg.sip9

MOVEMENT SUMMARY

Site: 18PM [ALE_HAS_23_18PM_DL (Site Folder: Network 1)]

Output produced by SIDRA INTERSECTION Version: 9.1.4.221

Network: N101 [Network 1 - PM (Network Folder: Base Year_DL)]

Alexandra Avenue and Hassall Street (5:00 to 6:00 PM)

TCS 3894 SS 44

Site Category: Base Year

Signals - EQUISAT (Fixed-Time/SCATS) Coordinated Cycle Time = 110 seconds (Network Practical Cycle Time)

Vehicle Movement Performance															
Mov ID	Turn	Mov Class	Demand Flows [Total HV]		Arrival Flows [Total HV]		Deg. Satn	Aver. Delay	Level of Service	Aver. Back Of Queue [Veh. Dist]		Prop. Que	Eff. Stop Rate	Aver. No. of Cycles	Aver. Speed
			veh/h	%	veh/h	%	v/c	sec		veh	m				km/h
South: Hassall Street															
1	L2	All MCs	520	2.0	520	2.0	* 1.194	260.9	LOS F	39.0	277.9	1.00	1.59	2.53	1.3
3	R2	All MCs	174	2.0	174	2.0	0.718	70.6	LOS F	5.5	38.9	0.96	0.85	1.06	24.8
Approach			694	2.0	694	2.0	1.194	213.1	LOS F	39.0	277.9	0.99	1.41	2.16	3.4
East: Alexandra Avenue (E)															
4	L2	All MCs	189	2.0	189	2.0	0.123	7.3	LOS A	1.1	7.8	0.19	0.63	0.19	46.8
5	T1	All MCs	849	2.0	849	2.0	* 1.179	209.5	LOS F	61.7	439.0	1.00	2.10	2.40	7.7
Approach			1039	2.0	1039	2.0	1.179	172.6	LOS F	61.7	439.0	0.85	1.83	1.99	9.3
West: Alexandra Avenue (W)															
11	T1	All MCs	363	10.4	363	10.4	0.167	15.1	LOS B	4.3	32.8	0.68	0.44	0.68	43.2
12	R2	All MCs	1	0.0	1	0.0	0.167	104.3	LOS F	4.3	32.8	0.83	0.47	0.83	23.3
Approach			364	10.4	364	10.4	0.167	15.4	LOS B	4.3	32.8	0.68	0.44	0.68	43.2
All Vehicles			2097	3.5	2097	3.5	1.194	158.7	LOS F	61.7	439.0	0.87	1.45	1.82	8.6

Site Level of Service (LOS) Method: Delay (RTA NSW). Site LOS Method is specified in the Network Data dialog (Override Site Data tab).

Vehicle movement LOS values are based on average delay per movement.

Intersection and Approach LOS values are based on average delay for all vehicle movements.

Delay Model: SIDRA Standard (Control Delay: Geometric Delay is included).

Queue Model: SIDRA queue estimation methods are used for Back of Queue and Queue at Start of Green.

Gap-Acceptance Capacity Formula: SIDRA Standard (Akçelik M3D).

HV (%) values are calculated for All Movement Classes of All Heavy Vehicle Model Designation.

Arrival Flows used in performance calculations are adjusted to include any Initial Queued Demand and Upstream Capacity Constraint effects.

* Critical Movement (Signal Timing)

Pedestrian Movement Performance											
Mov ID	Crossing	Dem. Flow ped/h	Aver. Delay sec	Level of Service	AVERAGE BACK OF QUEUE [Ped Dist]		Prop. Que	Eff. Stop Rate	Travel Time sec	Travel Dist. m	Aver. Speed m/sec
South: Hassall Street											
P1	Full	418	50.0	LOS E	1.3	1.3	0.96	0.96	203.9	200.0	0.98
West: Alexandra Avenue (W)											
P4	Full	206	49.6	LOS E	0.6	0.6	0.95	0.95	203.4	200.0	0.98
All Pedestrians		624	49.9	LOS E	1.3	1.3	0.96	0.96	203.7	200.0	0.98

Level of Service (LOS) Method: SIDRA Pedestrian LOS Method (Based on Average Delay)
 Pedestrian movement LOS values are based on average delay per pedestrian movement.
 Intersection LOS value for Pedestrians is based on average delay for all pedestrian movements.

MOVEMENT SUMMARY

Site: 21AM [BRI_MON_23_21AM_DL (Site Folder: Network 2)]

Output produced by SIDRA INTERSECTION Version: 9.1.4.221

Network: N101 [Network 2 - AM (Network Folder: Base Year_DL)]

Bridge Road and Entry to Monarco (8:00 to 9:00 AM)

Site Category: Base Year

Roundabout

Vehicle Movement Performance															
Mov ID	Turn	Mov Class	Demand Flows		Arrival Flows		Deg. Satn	Aver. Delay	Level of Service	Aver. Back Of Queue		Prop. Que	Eff. Stop Rate	Aver. No. of Cycles	Aver. Speed
			[Total	HV]	[Total	HV]				[Veh.	Dist]				
			veh/h	%	veh/h	%	v/c	sec		veh	m				
South: Bridge Road (S)															
2	T1	All MCs	864	2.0	781	2.2	0.476	3.9	LOS A	1.3	9.2	0.04	0.45	0.04	42.5
3	R2	All MCs	1	0.0	1	0.0	0.476	6.5	LOS A	1.3	9.2	0.04	0.45	0.04	38.3
3u	U	All MCs	1	0.0	1	0.0	0.476	7.8	LOS A	1.3	9.2	0.04	0.45	0.04	35.2
Approach			866	2.0	782	2.2	0.476	3.9	LOS A	1.3	9.2	0.04	0.45	0.04	42.5
East: Monarco Entry															
4	L2	All MCs	1	0.0	1	0.0	0.003	6.0	LOS A	0.0	0.0	0.42	0.59	0.42	30.9
6	R2	All MCs	1	0.0	1	0.0	0.003	8.1	LOS A	0.0	0.0	0.42	0.59	0.42	38.7
6u	U	All MCs	1	0.0	1	0.0	0.003	9.4	LOS A	0.0	0.0	0.42	0.59	0.42	35.1
Approach			3	0.0	3	0.0	0.003	7.8	LOS A	0.0	0.0	0.42	0.59	0.42	35.8
North: Bridge Road (N)															
7	L2	All MCs	1	0.0	1	0.0	0.229	4.8	LOS A	0.3	2.1	0.02	0.46	0.02	42.2
8	T1	All MCs	371	2.0	371	2.0	0.229	3.9	LOS A	0.3	2.1	0.02	0.46	0.02	42.7
9u	U	All MCs	1	0.0	1	0.0	0.229	7.8	LOS A	0.3	2.1	0.02	0.46	0.02	43.9
Approach			373	2.0	373	2.0	0.229	3.9	LOS A	0.3	2.1	0.02	0.46	0.02	42.7
All Vehicles			1243	2.0	1159	2.1	0.476	3.9	LOS A	1.3	9.2	0.03	0.45	0.03	42.5

Site Level of Service (LOS) Method: Delay (RTA NSW). Site LOS Method is specified in the Network Data dialog (Override Site Data tab).

Vehicle movement LOS values are based on average delay per movement.

Intersection and Approach LOS values are based on average delay for all vehicle movements.

Roundabout Capacity Model: SIDRA Standard.

Delay Model: SIDRA Standard (Control Delay: Geometric Delay is included).

Queue Model: SIDRA queue estimation methods are used for Back of Queue and Queue at Start of Gap.

Gap-Acceptance Capacity Formula: SIDRA Standard (Akçelik M3D).

HV (%) values are calculated for All Movement Classes of All Heavy Vehicle Model Designation.

Arrival Flows used in performance calculations are adjusted to include any Initial Queued Demand and Upstream Capacity Constraint effects.

SIDRA INTERSECTION 9.1 | Copyright © 2000-2023 Akcelik and Associates Pty Ltd | sidrasolutions.com

Organisation: SCT CONSULTING PTY LTD | Licence: NETWORK / 1PC | Processed: Thursday, 19 October 2023 3:09:48 PM

Project: S:\Projects\SCT_00410_Cumberland Westmead Sth Transport Study\3. Technical Work Area\1. Network Optimisation\SCT_00410_Cumberland Westmead Sth_SIDRA_v0.5_upg1_sg.sip9

MOVEMENT SUMMARY

Site: 24AMe [BRI_ALE_23_24AM_DL (Site Folder: Network 2)]

Output produced by SIDRA INTERSECTION Version: 9.1.4.221

Network: N101 [Network 2 - AM (Network Folder: Base Year_DL)]

Bridge Road and Alexandra Avenue (8:00 to 9:00 AM)

Site Category: Base Year

Roundabout

Vehicle Movement Performance															
Mov ID	Turn	Mov Class	Demand Flows		Arrival Flows		Deg. Satn	Aver. Delay	Level of Service	Aver. Back Of Queue		Prop. Que	Eff. Stop Rate	Aver. No. of Cycles	Aver. Speed
			[Total	HV]	[Total	HV]				[Veh.	Dist]				
			veh/h	%	veh/h	%	v/c	sec		veh	m				
South: Bridge Road (S)															
2	T1	All MCs	277	2.0	277	2.0	0.643	8.2	LOS A	1.9	13.6	0.69	0.90	0.81	19.3
3	R2	All MCs	203	2.0	203	2.0	0.643	11.2	LOS A	1.9	13.6	0.69	0.90	0.81	40.6
3u	U	All MCs	6	0.0	6	0.0	0.643	12.6	LOS A	1.9	13.6	0.69	0.90	0.81	19.3
Approach			486	2.0	486	2.0	0.643	9.5	LOS A	1.9	13.6	0.69	0.90	0.81	35.2
East: Alexandra Avenue															
4	L2	All MCs	349	2.0	349	2.0	1.158	157.6	LOS F	41.5	291.9	1.00	4.42	9.33	11.4
6	R2	All MCs	675	0.0	675	0.0	1.158	159.8	LOS F	41.5	291.9	1.00	4.42	9.33	11.4
6u	U	All MCs	1	0.0	1	0.0	1.158	161.1	LOS F	41.5	291.9	1.00	4.42	9.33	18.2
Approach			1024	0.7	1024	0.7	1.158	159.0	LOS F	41.5	291.9	1.00	4.42	9.33	11.4
North: Bridge Road (N)															
7	L2	All MCs	1	0.0	1	0.0	0.532	5.7	LOS A	1.8	13.1	0.60	0.53	0.60	43.3
8	T1	All MCs	572	2.0	571	2.0	0.532	5.4	LOS A	1.8	13.1	0.60	0.53	0.60	29.9
9u	U	All MCs	1	0.0	1	0.0	0.532	9.7	LOS A	1.8	13.1	0.60	0.53	0.60	29.9
Approach			574	2.0	574	2.0	0.532	5.4	LOS A	1.8	13.1	0.60	0.53	0.60	30.0
All Vehicles			2085	1.3	2084	1.3	1.158	81.9	LOS F	41.5	291.9	0.82	2.53	4.94	13.8

Site Level of Service (LOS) Method: Delay (RTA NSW). Site LOS Method is specified in the Network Data dialog (Override Site Data tab).

Vehicle movement LOS values are based on average delay per movement.

Intersection and Approach LOS values are based on average delay for all vehicle movements.

Roundabout Capacity Model: SIDRA Standard.

Delay Model: SIDRA Standard (Control Delay: Geometric Delay is included).

Queue Model: SIDRA queue estimation methods are used for Back of Queue and Queue at Start of Gap.

Gap-Acceptance Capacity Formula: SIDRA Standard (Akçelik M3D).

HV (%) values are calculated for All Movement Classes of All Heavy Vehicle Model Designation.

Arrival Flows used in performance calculations are adjusted to include any Initial Queued Demand and Upstream Capacity Constraint effects.

SIDRA INTERSECTION 9.1 | Copyright © 2000-2023 Akcelik and Associates Pty Ltd | sidrasolutions.com

Organisation: SCT CONSULTING PTY LTD | Licence: NETWORK / 1PC | Processed: Thursday, 19 October 2023 3:09:48 PM

Project: S:\Projects\SCT_00410_Cumberland Westmead Sth Transport Study\3. Technical Work Area\1. Network Optimisation\SCT_00410_Cumberland Westmead Sth_SIDRA_v0.5_upg1_sg.sip9

MOVEMENT SUMMARY

Site: 2AM [BRI_GRA_23_2AM_DL (Site Folder: Network 2)]

Output produced by SIDRA INTERSECTION Version: 9.1.4.221

Network: N101 [Network 2 - AM (Network Folder: Base Year_DL)]

Bridge Road and Grand Avenue (8:00 to 9:00 AM)

TCS 1570

Site Category: Base Year

Signals - EQUISAT (Fixed-Time/SCATS) Coordinated Cycle Time = 50 seconds (Site Practical Cycle Time)

Vehicle Movement Performance															
Mov ID	Turn	Mov Class	Demand Flows [Total HV]		Arrival Flows [Total HV]		Deg. Satn	Aver. Delay	Level of Service	Aver. Back Of Queue [Veh. Dist]		Prop. Que	Eff. Stop Rate	Aver. No. of Cycles	Aver. Speed
			veh/h	%	veh/h	%	v/c	sec		veh	m				km/h
South: Bridge Road (S)															
1	L2	All MCs	126	2.0	126	2.0	0.191	21.8	LOS B	1.9	13.5	1.00	0.69	1.00	30.4
2	T1	All MCs	277	2.0	277	2.0	0.343	18.2	LOS B	4.2	29.7	1.00	0.68	1.00	8.7
Approach			403	2.0	403	2.0	0.343	19.4	LOS B	4.2	29.7	1.00	0.68	1.00	20.8
East: Grand Avenue															
4	L2	All MCs	1	0.0	1	0.0	0.013	19.4	LOS B	0.0	0.4	0.78	0.60	0.78	34.4
5	T1	All MCs	1	0.0	1	0.0	0.013	12.5	LOS A	0.0	0.4	0.78	0.60	0.78	40.0
6	R2	All MCs	2	50.0	2	50.0	0.013	23.3	LOS B	0.0	0.4	0.78	0.60	0.78	34.7
Approach			4	25.0	4	25.0	0.013	19.6	LOS B	0.0	0.4	0.78	0.60	0.78	36.4
North: Bridge Road (N)															
7	L2	All MCs	1	0.0	1	0.0	0.596	20.3	LOS B	5.2	36.9	0.83	0.71	0.83	38.5
8	T1	All MCs	920	2.0	873	2.0	*0.596	13.2	LOS A	5.2	36.9	0.82	0.71	0.82	20.2
Approach			921	2.0	874	2.0	0.596	13.2	LOS A	5.2	36.9	0.82	0.71	0.82	19.4
West: Veron Street															
10	L2	All MCs	203	2.0	203	2.0	0.406	21.6	LOS B	2.6	18.3	0.86	0.78	0.86	31.0
11	T1	All MCs	325	2.0	325	2.0	*0.510	14.7	LOS B	4.0	28.5	0.85	0.72	0.85	42.0
Approach			528	2.0	528	2.0	0.510	17.3	LOS B	4.0	28.5	0.85	0.74	0.85	39.0
All Vehicles			1857	2.1	1809	2.1	0.596	15.8	LOS B	5.2	36.9	0.87	0.71	0.87	30.6

Site Level of Service (LOS) Method: Delay (RTA NSW). Site LOS Method is specified in the Network Data dialog (Override Site Data tab).

Vehicle movement LOS values are based on average delay per movement.

Intersection and Approach LOS values are based on average delay for all vehicle movements.

Delay Model: SIDRA Standard (Control Delay: Geometric Delay is included).

Queue Model: SIDRA queue estimation methods are used for Back of Queue and Queue at Start of Green.

Gap-Acceptance Capacity Formula: SIDRA Standard (Akçelik M3D).

HV (%) values are calculated for All Movement Classes of All Heavy Vehicle Model Designation.

Arrival Flows used in performance calculations are adjusted to include any Initial Queued Demand and Upstream Capacity Constraint effects.

* Critical Movement (Signal Timing)

Pedestrian Movement Performance												
Mov ID	Crossing	Dem. Flow ped/h	Aver. Delay sec	Level of Service	AVERAGE BACK OF QUEUE [Ped ped Dist] m		Prop. Que	Eff. Stop Rate	Travel Time sec	Travel Dist. m	Aver. Speed m/sec	
South: Bridge Road (S)												
P1	Full	211	19.5	LOS B	0.3	0.3	0.89	0.89	173.4	200.0	1.15	
East: Grand Avenue												
P2	Full	211	19.5	LOS B	0.3	0.3	0.89	0.89	173.4	200.0	1.15	
North: Bridge Road (N)												
P3	Full	211	19.5	LOS B	0.3	0.3	0.89	0.89	173.4	200.0	1.15	
West: Veron Street												
P4	Full	211	19.5	LOS B	0.3	0.3	0.89	0.89	173.4	200.0	1.15	
All Pedestrians		842	19.5	LOS B	0.3	0.3	0.89	0.89	173.4	200.0	1.15	

Level of Service (LOS) Method: SIDRA Pedestrian LOS Method (Based on Average Delay)

Pedestrian movement LOS values are based on average delay per pedestrian movement.

Intersection LOS value for Pedestrians is based on average delay for all pedestrian movements.

SIDRA INTERSECTION 9.1 | Copyright © 2000-2023 Akcelik and Associates Pty Ltd | sidrasolutions.com

Organisation: SCT CONSULTING PTY LTD | Licence: NETWORK / 1PC | Processed: Thursday, 19 October 2023 3:09:48 PM

Project: S:\Projects\SCT_00410_Cumberland Westmead Sth Transport Study\3. Technical Work Area\1. Network Optimisation\SCT_00410_Cumberland Westmead Sth_SIDRA_v0.5_upg1_sg.sip9

MOVEMENT SUMMARY

Site: 21PM [BRI_MON_23_21PM_DL (Site Folder: Network 2)]

Output produced by SIDRA INTERSECTION Version: 9.1.4.221

Network: N101 [Network 2 - PM (Network Folder: Base Year_DL)]

Bridge Road and Entry to Monarco (5:00 to 6:00 PM)

Site Category: Base Year

Roundabout

Vehicle Movement Performance															
Mov ID	Turn	Mov Class	Demand Flows		Arrival Flows		Deg. Satn	Aver. Delay	Level of Service	Aver. Back Of Queue		Prop. Que	Eff. Stop Rate	Aver. No. of Cycles	Aver. Speed
			[Total	HV]	[Total	HV]				[Veh.	Dist]				
			veh/h	%	veh/h	%	v/c	sec		veh	m				km/h
South: Bridge Road (S)															
2	T1	All MCs	669	2.0	326	2.0	0.202	3.9	LOS A	0.4	3.1	0.03	0.45	0.03	42.6
3	R2	All MCs	1	0.0	1	0.0	0.202	6.5	LOS A	0.4	3.1	0.03	0.45	0.03	38.3
3u	U	All MCs	1	0.0	1	0.0	0.202	7.8	LOS A	0.4	3.1	0.03	0.45	0.03	35.3
Approach			671	2.0	327	2.0	0.202	3.9	LOS A	0.4	3.1	0.03	0.45	0.03	42.6
East: Monarco Entry															
4	L2	All MCs	1	0.0	1	0.0	0.009	9.6	LOS A	0.0	0.1	0.82	0.67	0.82	26.3
6	R2	All MCs	1	0.0	1	0.0	0.009	11.7	LOS A	0.0	0.1	0.82	0.67	0.82	35.8
6u	U	All MCs	1	0.0	1	0.0	0.009	13.0	LOS A	0.0	0.1	0.82	0.67	0.82	31.7
Approach			3	0.0	3	0.0	0.009	11.4	LOS A	0.0	0.1	0.82	0.67	0.82	32.3
North: Bridge Road (N)															
7	L2	All MCs	1	0.0	1	0.0	1.031	33.8	LOS C	33.0	234.8	1.00	1.01	1.02	24.7
8	T1	All MCs	852	2.0	852	2.0	1.031	32.9	LOS C	33.0	234.8	1.00	1.01	1.02	20.7
9u	U	All MCs	1	0.0	1	0.0	1.031	36.8	LOS C	33.0	234.8	1.00	1.01	1.02	28.1
Approach			854	2.0	854	2.0	1.031	32.9	LOS C	33.0	234.8	1.00	1.01	1.02	20.7
All Vehicles			1528	2.0	1184	2.6	1.031	24.8	LOS B	33.0	234.8	0.73	0.85	0.74	25.1

Site Level of Service (LOS) Method: Delay (RTA NSW). Site LOS Method is specified in the Network Data dialog (Override Site Data tab).

Vehicle movement LOS values are based on average delay per movement.

Intersection and Approach LOS values are based on average delay for all vehicle movements.

Roundabout Capacity Model: SIDRA Standard.

Delay Model: SIDRA Standard (Control Delay: Geometric Delay is included).

Queue Model: SIDRA queue estimation methods are used for Back of Queue and Queue at Start of Gap.

Gap-Acceptance Capacity Formula: SIDRA Standard (Akçelik M3D).

HV (%) values are calculated for All Movement Classes of All Heavy Vehicle Model Designation.

Arrival Flows used in performance calculations are adjusted to include any Initial Queued Demand and Upstream Capacity Constraint effects.

SIDRA INTERSECTION 9.1 | Copyright © 2000-2023 Akcelik and Associates Pty Ltd | sidrasolutions.com

Organisation: SCT CONSULTING PTY LTD | Licence: NETWORK / 1PC | Processed: Thursday, 19 October 2023 3:09:43 PM

Project: S:\Projects\SCT_00410_Cumberland Westmead Sth Transport Study\3. Technical Work Area\1. Network Optimisation\SCT_00410_Cumberland Westmead Sth_SIDRA_v0.5_upg1_sg.sip9

MOVEMENT SUMMARY

Site: 24PMe [BRI_ALE_23_24PM_DL (Site Folder: Network 2)]

Output produced by SIDRA INTERSECTION Version: 9.1.4.221

Network: N101 [Network 2 - PM (Network Folder: Base Year_DL)]

Bridge Road and Alexandra Avenue (5:00 to 6:00 PM)

Site Category: Base Year

Roundabout

Vehicle Movement Performance															
Mov ID	Turn	Mov Class	Demand Flows		Arrival Flows		Deg. Satn	Aver. Delay	Level of Service	Aver. Back Of Queue		Prop. Que	Eff. Stop Rate	Aver. No. of Cycles	Aver. Speed
			[Total	HV]	[Total	HV]				[Veh.	Dist]				
			veh/h	%	veh/h	%	v/c	sec		veh	m				km/h
South: Bridge Road (S)															
2	T1	All MCs	283	2.0	283	2.0	0.381	4.7	LOS A	0.7	5.3	0.38	0.60	0.38	25.0
3	R2	All MCs	101	0.0	101	0.0	0.381	7.7	LOS A	0.7	5.3	0.38	0.60	0.38	43.1
3u	U	All MCs	2	0.0	2	0.0	0.381	9.1	LOS A	0.7	5.3	0.38	0.60	0.38	25.0
Approach			386	1.5	386	1.5	0.381	5.5	LOS A	0.7	5.3	0.38	0.60	0.38	36.6
East: Alexandra Avenue															
4	L2	All MCs	595	0.0	595	0.0	3.128	1926.3	LOS F	247.5	1749.7	1.00	13.48	31.29	1.2
6	R2	All MCs	840	2.0	840	2.0	3.128	1928.6	LOS F	247.5	1749.7	1.00	13.48	31.29	1.2
6u	U	All MCs	1	0.0	1	0.0	3.128	1929.9	LOS F	247.5	1749.7	1.00	13.48	31.29	2.3
Approach			1437	1.2	1437	1.2	3.128	1927.6	LOS F	247.5	1749.7	1.00	13.48	31.29	1.2
North: Bridge Road (N)															
7	L2	All MCs	1	0.0	1	0.0	1.066	71.8	LOS F	16.6	118.0	1.00	1.69	2.22	21.4
8	T1	All MCs	919	2.0	894	2.0	1.066	71.6	LOS F	16.6	118.0	1.00	1.69	2.22	6.0
9u	U	All MCs	1	0.0	1	0.0	1.066	75.8	LOS F	16.6	118.0	1.00	1.69	2.22	6.0
Approach			922	2.0	896	2.0	1.066	71.6	LOS F	16.6	118.0	1.00	1.69	2.22	6.0
All Vehicles			2745	1.5	2719	1.5	3.128	1043.1	LOS F	247.5	1749.7	0.91	7.77	17.32	1.4

Site Level of Service (LOS) Method: Delay (RTA NSW). Site LOS Method is specified in the Network Data dialog (Override Site Data tab).

Vehicle movement LOS values are based on average delay per movement.

Intersection and Approach LOS values are based on average delay for all vehicle movements.

Roundabout Capacity Model: SIDRA Standard.

Delay Model: SIDRA Standard (Control Delay: Geometric Delay is included).

Queue Model: SIDRA queue estimation methods are used for Back of Queue and Queue at Start of Gap.

Gap-Acceptance Capacity Formula: SIDRA Standard (Akçelik M3D).

HV (%) values are calculated for All Movement Classes of All Heavy Vehicle Model Designation.

Arrival Flows used in performance calculations are adjusted to include any Initial Queued Demand and Upstream Capacity Constraint effects.

SIDRA INTERSECTION 9.1 | Copyright © 2000-2023 Akcelik and Associates Pty Ltd | sidrasolutions.com

Organisation: SCT CONSULTING PTY LTD | Licence: NETWORK / 1PC | Processed: Thursday, 19 October 2023 3:09:43 PM

Project: S:\Projects\SCT_00410_Cumberland Westmead Sth Transport Study\3. Technical Work Area\1. Network Optimisation\SCT_00410_Cumberland Westmead Sth_SIDRA_v0.5_upg1_sg.sip9

MOVEMENT SUMMARY

Site: 2PM [BRI_GRA_23_2PM_DL (Site Folder: Network 2)]

Output produced by SIDRA INTERSECTION Version: 9.1.4.221

Network: N101 [Network 2 - PM (Network Folder: Base Year_DL)]

Bridge Road and Grand Avenue (5:00 to 6:00 PM)

TCS 1570

Site Category: Base Year

Signals - EQUISAT (Fixed-Time/SCATS) Isolated Cycle Time = 60 seconds (Site Practical Cycle Time)

Vehicle Movement Performance															
Mov ID	Turn	Mov Class	Demand Flows [Total HV]		Arrival Flows [Total HV]		Deg. Satn	Aver. Delay	Level of Service	Aver. Back Of Queue [Veh. Dist]		Prop. Que	Eff. Stop Rate	Aver. No. of Cycles	Aver. Speed
			veh/h	%	veh/h	%	v/c	sec		veh	m				km/h
South: Bridge Road (S)															
1	L2	All MCs	148	2.0	148	2.0	0.169	13.9	LOS A	1.6	11.3	0.63	0.70	0.63	35.0
2	T1	All MCs	283	2.0	283	2.0	0.284	8.9	LOS A	2.9	20.6	0.60	0.51	0.60	15.1
Approach			431	2.0	431	2.0	0.284	10.6	LOS A	2.9	20.6	0.61	0.58	0.61	28.7
East: Grand Avenue															
4	L2	All MCs	1	0.0	1	0.0	0.015	24.9	LOS B	0.1	0.5	0.81	0.61	0.81	32.3
5	T1	All MCs	1	0.0	1	0.0	0.015	17.0	LOS B	0.1	0.5	0.81	0.61	0.81	38.3
6	R2	All MCs	2	50.0	2	50.0	0.015	27.0	LOS B	0.1	0.5	0.81	0.61	0.81	32.5
Approach			4	25.0	4	25.0	0.015	24.0	LOS B	0.1	0.5	0.81	0.61	0.81	34.3
North: Bridge Road (N)															
7	L2	All MCs	1	0.0	1	0.0	* 0.713	24.2	LOS B	7.5	53.9	0.82	0.76	0.87	38.0
8	T1	All MCs	1515	2.0	1033	2.8	0.713	16.2	LOS B	7.5	53.9	0.82	0.76	0.87	19.3
Approach			1516	2.0	1034	2.8	0.713	16.2	LOS B	7.5	53.9	0.82	0.76	0.87	17.0
West: Veron Street															
10	L2	All MCs	101	2.0	101	2.0	0.262	26.9	LOS B	1.6	11.2	0.87	0.75	0.87	28.2
11	T1	All MCs	238	2.0	238	2.0	* 0.448	19.6	LOS B	3.6	25.7	0.87	0.72	0.87	39.8
Approach			340	2.0	340	2.0	0.448	21.8	LOS B	3.6	25.7	0.87	0.73	0.87	37.4
All Vehicles			2290	2.0	1808	2.6	0.713	16.0	LOS B	7.5	53.9	0.78	0.71	0.81	28.0

Site Level of Service (LOS) Method: Delay (RTA NSW). Site LOS Method is specified in the Network Data dialog (Override Site Data tab).

Vehicle movement LOS values are based on average delay per movement.

Intersection and Approach LOS values are based on average delay for all vehicle movements.

Delay Model: SIDRA Standard (Control Delay: Geometric Delay is included).

Queue Model: SIDRA queue estimation methods are used for Back of Queue and Queue at Start of Green.

Gap-Acceptance Capacity Formula: SIDRA Standard (Akçelik M3D).

HV (%) values are calculated for All Movement Classes of All Heavy Vehicle Model Designation.

Arrival Flows used in performance calculations are adjusted to include any Initial Queued Demand and Upstream Capacity Constraint effects.

* Critical Movement (Signal Timing)

Pedestrian Movement Performance												
Mov ID	Crossing	Dem. Flow ped/h	Aver. Delay sec	Level of Service	AVERAGE BACK OF QUEUE [Ped ped Dist] m		Prop. Que	Eff. Stop Rate	Travel Time sec	Travel Dist. m	Aver. Speed m/sec	
South: Bridge Road (S)												
P1	Full	211	24.5	LOS C	0.3	0.3	0.91	0.91	178.4	200.0	1.12	
East: Grand Avenue												
P2	Full	211	24.5	LOS C	0.3	0.3	0.91	0.91	178.4	200.0	1.12	
North: Bridge Road (N)												
P3	Full	211	24.5	LOS C	0.3	0.3	0.91	0.91	178.4	200.0	1.12	
West: Veron Street												
P4	Full	211	24.5	LOS C	0.3	0.3	0.91	0.91	178.4	200.0	1.12	
All Pedestrians		842	24.5	LOS C	0.3	0.3	0.91	0.91	178.4	200.0	1.12	

Level of Service (LOS) Method: SIDRA Pedestrian LOS Method (Based on Average Delay)

Pedestrian movement LOS values are based on average delay per pedestrian movement.

Intersection LOS value for Pedestrians is based on average delay for all pedestrian movements.

SIDRA INTERSECTION 9.1 | Copyright © 2000-2023 Akcelik and Associates Pty Ltd | sidrasolutions.com

Organisation: SCT CONSULTING PTY LTD | Licence: NETWORK / 1PC | Processed: Thursday, 19 October 2023 3:09:43 PM

Project: S:\Projects\SCT_00410_Cumberland Westmead Sth Transport Study\3. Technical Work Area\1. Network Optimisation\SCT_00410_Cumberland Westmead Sth_SIDRA_v0.5_upg1_sg.sip9

MOVEMENT SUMMARY

Site: 4AM [BRI_GWH_23_4AM_O2 (Site Folder: Network 3)]

Output produced by SIDRA INTERSECTION Version: 9.1.4.221

Network: N101 [Network 3 - AM (Network Folder: Base Year_DL)]

Bridge Road and Great Western Highway

TCS 1248 - SS 2

8:00 AM to 9:00 AM Base year demand

Site Category: Base Year

Signals - EQUISAT (Fixed-Time/SCATS) Coordinated Cycle Time = 141 seconds (Network User-Given Cycle Time)

Vehicle Movement Performance															
Mov ID	Turn	Mov Class	Demand Flows [Total HV]		Arrival Flows [Total HV]		Deg. Satn	Aver. Delay	Level of Service	Aver. Back Of Queue [Veh. Dist]		Prop. Que	Eff. Stop Rate	Aver. No. of Cycles	Aver. Speed
			veh/h	%	veh/h	%	v/c	sec		veh	m				km/h
East: Great Western Highway (E)															
5	T1	All MCs	874	4.2	873	4.2	0.297	2.9	LOS A	5.2	36.9	0.18	0.16	0.18	55.5
6	R2	All MCs	432	2.0	431	2.0	* 1.107	124.6	LOS F	12.8	91.0	1.00	1.24	1.70	16.7
Approach			1305	3.5	1304	3.5	1.107	43.2	LOS D	12.8	91.0	0.45	0.52	0.68	28.3
North: Bridge Road (N)															
7	L2	All MCs	572	2.0	572	2.0	1.278	269.5	LOS F	49.1	349.8	1.00	1.67	2.45	7.9
9	R2	All MCs	213	2.0	213	2.0	* 1.098	184.4	LOS F	7.0	49.6	1.00	1.21	1.84	17.5
Approach			784	2.0	784	2.0	1.278	246.5	LOS F	49.1	349.8	1.00	1.54	2.29	9.9
West: Great Western Highway (W)															
10	L2	All MCs	5	1.9	5	1.9	0.035	6.2	LOS A	0.0	0.3	0.02	0.14	0.02	51.4
11	T1	All MCs	1320	3.5	1320	3.5	* 1.114	122.5	LOS F	46.9	333.6	0.99	1.59	1.75	12.1
Approach			1325	3.5	1325	3.5	1.114	122.1	LOS F	46.9	333.6	0.98	1.59	1.74	12.2
All Vehicles			3415	3.1	3413	3.1	1.278	120.5	LOS F	49.1	349.8	0.78	1.17	1.46	14.4

Site Level of Service (LOS) Method: Delay (RTA NSW). Site LOS Method is specified in the Network Data dialog (Override Site Data tab).

Vehicle movement LOS values are based on average delay per movement.

Intersection and Approach LOS values are based on average delay for all vehicle movements.

Delay Model: SIDRA Standard (Control Delay: Geometric Delay is included).

Queue Model: SIDRA queue estimation methods are used for Back of Queue and Queue at Start of Green.

Gap-Acceptance Capacity Formula: SIDRA Standard (Akçelik M3D).

HV (%) values are calculated for All Movement Classes of All Heavy Vehicle Model Designation.

Arrival Flows used in performance calculations are adjusted to include any Initial Queued Demand and Upstream Capacity Constraint effects.

* Critical Movement (Signal Timing)

Pedestrian Movement Performance												
Mov ID	Crossing	Dem. Flow ped/h	Aver. Delay sec	Level of Service	AVERAGE BACK OF QUEUE [Ped Dist] ped m		Prop. Que	Eff. Stop Rate	Travel Time sec	Travel Dist. m	Aver. Speed m/sec	
North: Bridge Road (N)												
P3	Full	53	64.8	LOS F	0.2	0.2	0.96	0.96	218.6	200.0	0.91	
West: Great Western Highway (W)												
P41	Stage 1	53	64.8	LOS F	0.2	0.2	0.96	0.96	218.6	200.0	0.91	
P42	Stage 2	53	64.8	LOS F	0.2	0.2	0.96	0.96	218.6	200.0	0.91	
All Pedestrians		158	64.8	LOS F	0.2	0.2	0.96	0.96	218.6	200.0	0.91	

Level of Service (LOS) Method: SIDRA Pedestrian LOS Method (Based on Average Delay)
 Pedestrian movement LOS values are based on average delay per pedestrian movement.
 Intersection LOS value for Pedestrians is based on average delay for all pedestrian movements.

MOVEMENT SUMMARY

Site: 5AM [HAW_GWH_23_5AM_DL_O2 (Site Folder: Network 3)]

Output produced by SIDRA INTERSECTION Version: 9.1.4.221

Network: N101 [Network 3 - AM (Network Folder: Base Year_DL)]

TCS 502 - SS 2

8:00 AM to 9:00 AM Base year demand

Site Category: Base Year

Signals - EQUISAT (Fixed-Time/SCATS) Coordinated Cycle Time = 141 seconds (Network User-Given Cycle Time)

Vehicle Movement Performance															
Mov ID	Turn	Mov Class	Demand Flows [Total HV]	Flows %	Arrival Flows [Total HV]	Flows %	Deg. Satn	Aver. Delay	Level of Service	Aver. Back Of Queue [Veh. Dist]	Prop. Que	Eff. Stop Rate	Aver. No. of Cycles	Aver. Speed	
			veh/h	%	veh/h	%	v/c	sec		veh	m				km/h
South: Coleman Street (S)															
1	L2	All MCs	393	2.0	393	2.0	0.740	32.5	LOS C	14.0	99.5	0.94	0.89	0.94	29.6
2	T1	All MCs	320	2.0	320	2.0	* 1.003	108.5	LOS F	17.0	120.4	1.00	1.23	1.52	21.7
3	R2	All MCs	258	2.0	258	2.0	1.003	115.1	LOS F	15.9	113.4	1.00	1.16	1.53	20.7
Approach			971	2.0	971	2.0	1.003	79.5	LOS F	17.0	120.4	0.97	1.07	1.29	22.9
East: Great Western Highway (E)															
4	L2	All MCs	69	2.0	69	2.0	0.087	7.8	LOS A	0.7	5.7	0.35	0.56	0.35	50.7
5	T1	All MCs	652	5.0	652	5.0	0.607	13.7	LOS A	13.4	95.1	0.55	0.50	0.55	41.8
6	R2	All MCs	476	2.0	476	2.0	* 0.993	111.3	LOS F	13.3	94.6	1.00	1.12	1.53	21.0
Approach			1197	3.6	1197	3.6	0.993	52.2	LOS D	13.4	95.1	0.72	0.75	0.93	27.5
North: Hawkesbury Road (N)															
7	L2	All MCs	470	2.0	470	2.0	0.886	83.2	LOS F	21.1	150.5	1.00	0.95	1.16	29.0
8	T1	All MCs	196	2.0	196	2.0	0.993	126.6	LOS F	15.5	110.1	1.00	1.22	1.52	21.8
9	R2	All MCs	260	2.0	260	2.0	* 0.993	123.1	LOS F	15.5	110.1	1.00	1.18	1.58	12.7
Approach			927	2.0	927	2.0	0.993	103.6	LOS F	21.1	150.5	1.00	1.07	1.35	20.1
West: Great Western Highway (W)															
10	L2	All MCs	461	2.0	397	2.0	0.490	20.0	LOS B	7.8	57.6	0.81	0.77	0.81	35.6
11	T1	All MCs	1431	3.5	1236	3.7	* 0.901	35.2	LOS C	12.8	91.0	0.94	0.91	1.02	30.8
Approach			1891	3.1	1634	3.3	0.901	31.5	LOS C	12.8	91.0	0.91	0.87	0.97	31.9
All Vehicles			4986	2.8	4729	3.0	1.003	60.7	LOS E	21.1	150.5	0.89	0.92	1.10	25.2

Site Level of Service (LOS) Method: Delay (RTA NSW). Site LOS Method is specified in the Network Data dialog (Override Site Data tab).

Vehicle movement LOS values are based on average delay per movement.

Intersection and Approach LOS values are based on average delay for all vehicle movements.

Delay Model: SIDRA Standard (Control Delay: Geometric Delay is included).

Queue Model: SIDRA queue estimation methods are used for Back of Queue and Queue at Start of Green.

Gap-Acceptance Capacity Formula: SIDRA Standard (Akçelik M3D).

HV (%) values are calculated for All Movement Classes of All Heavy Vehicle Model Designation.

Arrival Flows used in performance calculations are adjusted to include any Initial Queued Demand and Upstream Capacity Constraint effects.

* Critical Movement (Signal Timing)

Pedestrian Movement Performance											
Mov ID	Crossing	Dem. Flow ped/h	Aver. Delay sec	Level of Service	AVERAGE BACK OF QUEUE [Ped Dist]		Prop. Que	Eff. Stop Rate	Travel Time sec	Travel Dist. m	Aver. Speed m/sec
South: Coleman Street (S)											
P1	Full	53	64.8	LOS F	0.2	0.2	0.96	0.96	218.6	200.0	0.91
East: Great Western Highway (E)											
P2	Full	11	64.7	LOS F	0.0	0.0	0.96	0.96	218.5	200.0	0.92
North: Hawkesbury Road (N)											
P3	Full	53	64.8	LOS F	0.2	0.2	0.96	0.96	218.6	200.0	0.91
All Pedestrians		116	64.8	LOS F	0.2	0.2	0.96	0.96	218.6	200.0	0.91

Level of Service (LOS) Method: SIDRA Pedestrian LOS Method (Based on Average Delay)

Pedestrian movement LOS values are based on average delay per pedestrian movement.

Intersection LOS value for Pedestrians is based on average delay for all pedestrian movements.

SIDRA INTERSECTION 9.1 | Copyright © 2000-2023 Akcelik and Associates Pty Ltd | sidrasolutions.com

Organisation: SCT CONSULTING PTY LTD | Licence: NETWORK / 1PC | Processed: Thursday, 19 October 2023 3:27:17 PM

Project: S:\Projects\SCT_00410_Cumberland Westmead Sth Transport Study\3. Technical Work Area\1. Network Optimisation\SCT_00410_Cumberland Westmead Sth_SIDRA_v0.5_upg1_sg.sip9

MOVEMENT SUMMARY

Site: 4PM [BRI_GWH_23_4PM_O2 (Site Folder: Network 3)]

Output produced by SIDRA INTERSECTION Version: 9.1.4.221

Network: N102 [Network 3 - PM (Network Folder: Base Year_DL)]

Bridge Road and Great Western Highway

TCS 1248 - SS 2

5:00 PM to 6:00 PM Base year demand

Site Category: Base Year

Signals - EQUISAT (Fixed-Time/SCATS) Coordinated Cycle Time = 141 seconds (Network Site User-Given Phase Times)

Vehicle Movement Performance															
Mov ID	Turn	Mov Class	Demand Flows [Total HV]		Arrival Flows [Total HV]		Deg. Satn	Aver. Delay	Level of Service	Aver. Back Of Queue [Veh. Dist]		Prop. Que	Eff. Stop Rate	Aver. No. of Cycles	Aver. Speed
			veh/h	%	veh/h	%	v/c	sec		veh	m				km/h
East: Great Western Highway (E)															
5	T1	All MCs	1680	2.7	1256	2.9	0.465	1.9	LOS A	3.3	23.5	0.14	0.13	0.14	57.1
6	R2	All MCs	589	2.0	439	2.0	*0.940	74.2	LOS F	12.8	91.0	1.00	1.02	1.23	22.8
Approach			2269	2.5	1695	2.7	0.940	20.6	LOS B	12.8	91.0	0.36	0.36	0.42	38.0
North: Bridge Road (N)															
7	L2	All MCs	854	2.0	854	2.0	1.408	406.7	LOS F	85.1	605.8	1.00	1.98	2.88	5.8
9	R2	All MCs	274	2.0	274	2.0	*0.930	95.0	LOS F	8.5	60.8	1.00	1.05	1.28	25.7
Approach			1129	2.0	1129	2.0	1.408	330.9	LOS F	85.1	605.8	1.00	1.75	2.49	7.6
West: Great Western Highway (W)															
10	L2	All MCs	1	0.0	1	0.0	0.022	12.5	LOS A	0.1	1.2	0.19	0.18	0.19	48.6
11	T1	All MCs	916	3.2	916	3.2	*0.916	24.0	LOS B	16.1	114.9	0.72	0.77	0.86	33.8
Approach			917	3.2	917	3.2	0.916	23.9	LOS B	16.1	114.9	0.72	0.77	0.86	33.9
All Vehicles			4315	2.5	3741	2.9	1.408	115.1	LOS F	85.1	605.8	0.64	0.88	1.15	14.9

Site Level of Service (LOS) Method: Delay (RTA NSW). Site LOS Method is specified in the Network Data dialog (Override Site Data tab).

Vehicle movement LOS values are based on average delay per movement.

Intersection and Approach LOS values are based on average delay for all vehicle movements.

Delay Model: SIDRA Standard (Control Delay: Geometric Delay is included).

Queue Model: SIDRA queue estimation methods are used for Back of Queue and Queue at Start of Green.

Gap-Acceptance Capacity Formula: SIDRA Standard (Akçelik M3D).

HV (%) values are calculated for All Movement Classes of All Heavy Vehicle Model Designation.

Arrival Flows used in performance calculations are adjusted to include any Initial Queued Demand and Upstream Capacity Constraint effects.

* Critical Movement (Signal Timing)

Pedestrian Movement Performance												
Mov ID	Crossing	Dem. Flow ped/h	Aver. Delay sec	Level of Service	AVERAGE BACK OF QUEUE [Ped Dist] ped m		Prop. Que	Eff. Stop Rate	Travel Time sec	Travel Dist. m	Aver. Speed m/sec	
North: Bridge Road (N)												
P3	Full	53	64.8	LOS F	0.2	0.2	0.96	0.96	218.6	200.0	0.91	
West: Great Western Highway (W)												
P41	Stage 1	53	64.8	LOS F	0.2	0.2	0.96	0.96	218.6	200.0	0.91	
P42	Stage 2	53	64.8	LOS F	0.2	0.2	0.96	0.96	218.6	200.0	0.91	
All Pedestrians		158	64.8	LOS F	0.2	0.2	0.96	0.96	218.6	200.0	0.91	

Level of Service (LOS) Method: SIDRA Pedestrian LOS Method (Based on Average Delay)
 Pedestrian movement LOS values are based on average delay per pedestrian movement.
 Intersection LOS value for Pedestrians is based on average delay for all pedestrian movements.

MOVEMENT SUMMARY

Site: 5PM [HAW_GWH_23_5PM_DL_O2 (Site Folder: Network 3)]

Output produced by SIDRA INTERSECTION Version: 9.1.4.221

Network: N102 [Network 3 - PM (Network Folder: Base Year_DL)]

TCS 502 - SS 2

5:00 PM to 6:00 PM Base year demand

Site Category: Base Year

Signals - EQUISAT (Fixed-Time/SCATS) Coordinated Cycle Time = 141 seconds (Network Site User-Given Phase Times)

Vehicle Movement Performance															
Mov ID	Turn	Mov Class	Demand Flows [Total HV]	Flows %	Arrival Flows [Total HV]	Flows %	Deg. Satn	Aver. Delay	Level of Service	Aver. Back Of Queue [Veh. Dist]	Prop. Que	Eff. Stop Rate	Aver. No. of Cycles	Aver. Speed	
			veh/h	%	veh/h	%	v/c	sec		veh	m			km/h	
South: Coleman Street (S)															
1	L2	All MCs	521	2.0	521	2.0	2.693	1571.8	LOS F	86.7	617.2	1.00	2.64	5.03	1.2
2	T1	All MCs	378	2.0	378	2.0	* 3.012	1890.8	LOS F	46.6	331.8	1.00	2.43	5.28	1.9
3	R2	All MCs	122	2.0	122	2.0	3.012	1896.6	LOS F	44.5	317.2	1.00	2.41	5.28	1.9
Approach			1021	2.0	1021	2.0	3.012	1728.8	LOS F	86.7	617.2	1.00	2.54	5.15	1.5
East: Great Western Highway (E)															
4	L2	All MCs	157	2.0	157	2.0	0.112	21.4	LOS B	1.0	7.5	0.18	0.57	0.18	52.3
5	T1	All MCs	1519	2.7	1519	2.7	* 1.138	172.4	LOS F	109.1	776.9	0.99	1.66	1.83	9.9
6	R2	All MCs	690	2.0	690	2.0	0.893	76.3	LOS F	16.0	114.0	1.00	0.99	1.21	26.3
Approach			2366	2.5	2366	2.5	1.138	134.4	LOS F	109.1	776.9	0.94	1.39	1.54	14.2
North: Hawkesbury Road (N)															
7	L2	All MCs	473	2.0	473	2.0	0.946	102.7	LOS F	24.4	173.5	1.00	1.04	1.29	25.4
8	T1	All MCs	210	2.0	210	2.0	* 1.425	481.4	LOS F	31.1	221.2	1.00	1.99	3.01	7.1
9	R2	All MCs	229	2.0	229	2.0	1.425	476.1	LOS F	31.1	221.2	1.00	1.82	3.04	3.8
Approach			912	2.0	912	2.0	1.425	283.5	LOS F	31.1	221.2	1.00	1.45	2.12	9.5
West: Great Western Highway (W)															
10	L2	All MCs	428	2.0	368	2.0	0.364	17.6	LOS B	7.6	55.3	0.69	0.68	0.69	38.0
11	T1	All MCs	1342	2.8	1155	3.0	0.604	17.1	LOS B	12.8	91.0	0.61	0.55	0.61	41.0
Approach			1770	2.6	1522	2.7	0.604	17.3	LOS B	12.8	91.0	0.63	0.58	0.63	40.2
All Vehicles			6068	2.4	5821	2.5	3.012	406.7	LOS F	109.1	776.9	0.88	1.39	2.03	5.7

Site Level of Service (LOS) Method: Delay (RTA NSW). Site LOS Method is specified in the Network Data dialog (Override Site Data tab).

Vehicle movement LOS values are based on average delay per movement.

Intersection and Approach LOS values are based on average delay for all vehicle movements.

Delay Model: SIDRA Standard (Control Delay: Geometric Delay is included).

Queue Model: SIDRA queue estimation methods are used for Back of Queue and Queue at Start of Green.

Gap-Acceptance Capacity Formula: SIDRA Standard (Akçelik M3D).

HV (%) values are calculated for All Movement Classes of All Heavy Vehicle Model Designation.

Arrival Flows used in performance calculations are adjusted to include any Initial Queued Demand and Upstream Capacity Constraint effects.

* Critical Movement (Signal Timing)

Pedestrian Movement Performance											
Mov ID	Crossing	Dem. Flow ped/h	Aver. Delay sec	Level of Service	AVERAGE BACK OF QUEUE [Ped Dist]		Prop. Que	Eff. Stop Rate	Travel Time sec	Travel Dist. m	Aver. Speed m/sec
South: Coleman Street (S)											
P1	Full	53	64.8	LOS F	0.2	0.2	0.96	0.96	218.6	200.0	0.91
East: Great Western Highway (E)											
P2	Full	11	64.7	LOS F	0.0	0.0	0.96	0.96	218.5	200.0	0.92
North: Hawkesbury Road (N)											
P3	Full	53	64.8	LOS F	0.2	0.2	0.96	0.96	218.6	200.0	0.91
All Pedestrians		116	64.8	LOS F	0.2	0.2	0.96	0.96	218.6	200.0	0.91

Level of Service (LOS) Method: SIDRA Pedestrian LOS Method (Based on Average Delay)

Pedestrian movement LOS values are based on average delay per pedestrian movement.

Intersection LOS value for Pedestrians is based on average delay for all pedestrian movements.

SIDRA INTERSECTION 9.1 | Copyright © 2000-2023 Akcelik and Associates Pty Ltd | sidrasolutions.com

Organisation: SCT CONSULTING PTY LTD | Licence: NETWORK / 1PC | Processed: Thursday, 19 October 2023 3:42:26 PM

Project: S:\Projects\SCT_00410_Cumberland Westmead Sth Transport Study\3. Technical Work Area\1. Network Optimisation\SCT_00410_Cumberland Westmead Sth_SIDRA_v0.5_upg1_sg.sip9

CCG MOVEMENT SUMMARY

Common Control Group: CCG1 [TCS 1571]

Output produced by SIDRA INTERSECTION Version: 9.1.4.221

Network: N101 [Network 1 - AM (Network Folder: Base Year_DL)]

EQUISAT (Fixed-Time/SCATS) Coordinated Cycle Time = 110 seconds (Network Practical Cycle Time)

Vehicle Movement Performance (CCG)															
Mov ID	Turn	Mov Class	Demand Flows		Arrival Flows		Deg. Satn	Aver. Delay	Level of Service	95% Back Of Queue		Prop. Que	Eff. Stop Rate	Aver. No. of Cycles	Aver. Speed
			[Total	HV]	[Total	HV]				[Veh.	Dist]				
			veh/h	%	veh/h	%	v/c	sec		veh	m			km/h	
Site: 14AM [HAW_RAI_23_14AM_DL]															
South: Hawkesbury Road (S)															
2	T1	All MCs	841	2.0	712	2.0	0.484	15.0	LOS B	12.6	89.8	0.76	0.51	0.76	21.2
3	R2	All MCs	384	2.0	325	2.0	0.484	21.2	LOS B	12.6	89.8	0.73	0.70	0.73	30.8
Approach			1225	2.0	1038	2.0	0.484	17.0	LOS B	12.6	89.8	0.75	0.57	0.75	26.2
East: Railway Parade															
4	L2	All MCs	71	2.0	71	2.0	0.071	15.4	LOS B	1.7	12.2	0.49	0.62	0.49	31.4
6	R2	All MCs	7	2.0	7	2.0	0.027	45.9	LOS D	0.3	2.4	0.87	0.64	0.87	23.8
Approach			79	2.0	79	2.0	0.071	18.2	LOS B	1.7	12.2	0.52	0.62	0.52	30.3
North: Hawkesbury Road (N)															
7	L2	All MCs	93	2.0	93	2.0	0.187	34.3	LOS C	3.8	28.1	0.78	0.72	0.78	26.4
8	T1	All MCs	229	16.9	229	16.9	0.187	27.7	LOS B	4.3	34.2	0.75	0.60	0.75	12.7
Approach			322	12.6	322	12.6	0.187	29.6	LOS C	4.3	34.2	0.76	0.64	0.76	19.7
All Vehicles			1625	4.1	1438	4.6	0.484	19.9	LOS B	12.6	89.8	0.74	0.59	0.74	24.9
Site: 13AM [HAW_ALE_23_13AM_DL]															
South: Hawkesbury Road (S)															
1	L2	All MCs	1	0.0	1	0.0	1.125	158.4	LOS F	25.2	179.4	1.00	1.67	2.04	13.8
2	T1	All MCs	506	2.0	506	2.0	* 1.125	152.6	LOS F	25.2	179.4	1.00	1.67	2.04	4.3
Approach			507	2.0	507	2.0	1.125	152.6	LOS F	25.2	179.4	1.00	1.67	2.04	4.3
East: Alexandra Avenue (E)															
4	L2	All MCs	1	0.0	1	0.0	1.095	164.0	LOS F	35.1	249.7	1.00	1.70	2.00	3.8
5	T1	All MCs	572	2.0	458	2.0	* 1.095	153.4	LOS F	35.1	249.7	1.00	1.70	2.00	13.7
6	R2	All MCs	504	2.0	403	2.0	1.095	165.0	LOS F	35.1	249.7	1.00	1.58	2.09	3.6

Approach			1077	2.0	862	2.0	1.095	158.8	LOS F	35.1	249.7	1.00	1.65	2.05	9.4
North: Hawkesbury Road (N)															
7	L2	All MCs	206	18.5	206	18.5	0.355	9.7	LOS A	4.6	32.6	0.33	0.59	0.33	14.4
8	T1	All MCs	60	2.0	60	2.0	0.355	25.0	LOS B	4.6	32.6	0.39	0.60	0.39	13.2
9	R2	All MCs	34	2.0	34	2.0	0.185	54.4	LOS D	1.8	12.8	0.97	0.70	0.97	23.7
Approach			300	13.3	300	13.3	0.355	17.8	LOS B	4.6	32.6	0.42	0.60	0.42	18.2
West: Alexandra Avenue (W)															
10	L2	All MCs	215	2.0	215	2.0	* 0.829	37.6	LOS C	8.9	63.6	0.97	0.96	1.16	27.6
11	T1	All MCs	74	2.0	74	2.0	0.183	35.2	LOS C	3.0	21.6	0.80	0.62	0.80	28.6
Approach			288	2.0	288	2.0	0.829	37.0	LOS C	8.9	63.6	0.92	0.87	1.06	27.9
All Vehicles			2173	3.6	1958	4.0	1.125	117.7	LOS F	35.1	249.7	0.90	1.38	1.65	9.7

Site Level of Service (LOS) Method: Delay (RTA NSW). Site LOS Method is specified in the Network Data dialog (Override Site Data tab).

Vehicle movement LOS values are based on average delay per movement.

Intersection and Approach LOS values are based on average delay for all vehicle movements.

Delay Model: SIDRA Standard (Control Delay: Geometric Delay is included).

Gap-Acceptance Capacity Formula: SIDRA Standard (Akçelik M3D).

HV (%) values are calculated for All Movement Classes of All Heavy Vehicle Model Designation.

Arrival Flows used in performance calculations are adjusted to include any Initial Queued Demand and Upstream Capacity Constraint effects.

* Critical Movement (Signal Timing)

Pedestrian Movement Performance (CCG)											
Mov ID	Crossing	Dem. Flow ped/h	Aver. Delay sec	Level of Service	AVERAGE BACK OF QUEUE [Ped Dist]		Prop. Que	Eff. Stop Rate	Travel Time sec	Travel Dist. m	Aver. Speed m/sec
Site: 14AM [HAW_RAI_23_14AM_DL]											
South: Hawkesbury Road (S)											
P1	Full	726	50.7	LOS E	2.2	2.2	0.97	0.97	204.5	200.0	0.98
East: Railway Parade											
P2	Full	2737	55.5	LOS E	9.1	9.1	1.07	1.07	209.3	200.0	0.96
North: Hawkesbury Road (N)											
P3	Full	726	50.7	LOS E	2.2	2.2	0.97	0.97	204.5	200.0	0.98
All Pedestrians		4189	53.8	LOS E	9.1	9.1	1.04	1.04	207.7	200.0	0.96
Site: 13AM [HAW_ALE_23_13AM_DL]											

South: Hawkesbury Road (S)											
P1	Full	1461	52.4	LOS E	4.6	4.6	1.01	1.01	206.2	200.0	0.97
East: Alexandra Avenue (E)											
P2	Full	2641	55.2	LOS E	8.8	8.8	1.06	1.06	209.1	200.0	0.96
West: Alexandra Avenue (W)											
P4	Full	173	49.5	LOS E	0.5	0.5	0.95	0.95	203.4	200.0	0.98
All Pedestrians		4275	54.0	LOS E	8.8	8.8	1.04	1.04	207.9	200.0	0.96

Level of Service (LOS) Method: SIDRA Pedestrian LOS Method (Based on Average Delay)
 Pedestrian movement LOS values are based on average delay per pedestrian movement.
 Intersection LOS value for Pedestrians is based on average delay for all pedestrian movements.

MOVEMENT SUMMARY

Site: 12AM [HAW_PRI_23_12AM_DL (Site Folder: Network 1)]

Output produced by SIDRA INTERSECTION Version: 9.1.4.221

Network: N101 [Network 1 - AM (Network Folder: Base Year_DL)]

TCS 1583 SS 44 7:30 AM - 8:30 AM

Site Category: Base Year

Signals - EQUISAT (Fixed-Time/SCATS) Coordinated Cycle Time = 111 seconds (Site User-Given Phase Times)

Vehicle Movement Performance															
Mov ID	Turn	Mov Class	Demand Flows		Arrival Flows		Deg. Satn	Aver. Delay	Level of Service	95% Back Of Queue		Prop. Que	Eff. Stop Rate	Aver. No. of Cycles	Aver. Speed
			[Total	HV]	[Total	HV]				[Veh.	Dist]				
			veh/h	%	veh/h	%	v/c	sec							km/h
South: Hawkesbury Road (S)															
2	T1	All MCs	373	2.0	373	2.0	0.244	12.9	LOS A	6.9	49.1	0.56	0.49	0.56	18.8
3	R2	All MCs	79	2.0	79	2.0	* 0.244	21.0	LOS B	5.6	39.8	0.60	0.57	0.60	22.6
Approach			452	2.0	452	2.0	0.244	14.3	LOS A	6.9	49.1	0.56	0.51	0.56	19.8
East: Priddle Street															
4	L2	All MCs	1	0.0	1	0.0	0.001	26.1	LOS B	0.0	0.3	0.72	0.57	0.72	12.6
6	R2	All MCs	1	0.0	1	0.0	0.002	29.2	LOS C	0.0	0.3	0.68	0.56	0.68	11.6
Approach			2	0.0	2	0.0	0.002	27.7	LOS B	0.0	0.3	0.70	0.57	0.70	12.1
North: Hawkesbury Road (N)															
7	L2	All MCs	68	2.0	68	2.0	0.091	25.0	LOS B	2.2	15.9	0.65	0.67	0.65	20.9
8	T1	All MCs	85	2.0	85	2.0	* 0.100	18.5	LOS B	2.6	18.4	0.61	0.48	0.61	19.6
Approach			154	2.0	153	2.0	0.100	21.4	LOS B	2.6	18.4	0.62	0.57	0.62	20.3
All Vehicles			608	2.0	608	2.0	0.244	16.1	LOS B	6.9	49.1	0.58	0.52	0.58	19.9

Site Level of Service (LOS) Method: Delay (RTA NSW). Site LOS Method is specified in the Network Data dialog (Override Site Data tab).

Vehicle movement LOS values are based on average delay per movement.

Intersection and Approach LOS values are based on average delay for all vehicle movements.

Delay Model: SIDRA Standard (Control Delay: Geometric Delay is included).

Queue Model: SIDRA queue estimation methods are used for Back of Queue and Queue at Start of Green.

Gap-Acceptance Capacity Formula: SIDRA Standard (Akçelik M3D).

HV (%) values are calculated for All Movement Classes of All Heavy Vehicle Model Designation.

Arrival Flows used in performance calculations are adjusted to include any Initial Queued Demand and Upstream Capacity Constraint effects.

* Critical Movement (Signal Timing)

Pedestrian Movement Performance											
Mov ID	Crossing	Dem. Flow ped/h	Aver. Delay sec	Level of Service	AVERAGE BACK OF QUEUE [Ped Dist]		Prop. Que	Eff. Stop Rate	Travel Time sec	Travel Dist. m	Aver. Speed m/sec
South: Hawkesbury Road (S)											
P1	Full	211	50.1	LOS E	0.6	0.6	0.95	0.95	203.9	200.0	0.98
East: Priddle Street											
P2	Full	211	50.1	LOS E	0.6	0.6	0.95	0.95	203.9	200.0	0.98
North: Hawkesbury Road (N)											
P3	Full	211	50.1	LOS E	0.6	0.6	0.95	0.95	203.9	200.0	0.98
All Pedestrians		632	50.1	LOS E	0.6	0.6	0.95	0.95	203.9	200.0	0.98

Level of Service (LOS) Method: SIDRA Pedestrian LOS Method (Based on Average Delay)
 Pedestrian movement LOS values are based on average delay per pedestrian movement.
 Intersection LOS value for Pedestrians is based on average delay for all pedestrian movements.

SIDRA INTERSECTION 9.1 | Copyright © 2000-2023 Akcelik and Associates Pty Ltd | sidrasolutions.com

Organisation: SCT CONSULTING PTY LTD | Licence: NETWORK / 1PC | Processed: Wednesday, 18 October 2023 3:20:20 PM

Project: S:\Projects\SCT_00410_Cumberland Westmead Sth Transport Study\3. Technical Work Area\1. Network Optimisation\SCT_00410_Cumberland Westmead Sth_SIDRA_v0.5_upg2_sg0.9.sip9

MOVEMENT SUMMARY

Site: 22AM [HAW_NOL_23_22AM_DL (Site Folder: Network 1)]

Output produced by SIDRA INTERSECTION Version: 9.1.4.221

Network: N101 [Network 1 - AM (Network Folder: Base Year_DL)]

Hawkesbury Road and Nolan Crescent
7:30 AM to 8:30 AM base year demand
Site Category: Base Year
Give-Way (Two-Way)

Vehicle Movement Performance															
Mov ID	Turn	Mov Class	Demand Flows [Total HV]		Arrival Flows [Total HV]		Deg. Satn	Aver. Delay	Level of Service	95% Back Of Queue [Veh. Dist]		Prop. Que	Eff. Stop Rate	Aver. No. of Cycles	Aver. Speed
			veh/h	%	veh/h	%	v/c	sec		veh	m				km/h
South: Hawkesbury Road (S)															
1	L2	All MCs	1	0.0	1	0.0	0.001	4.6	LOS A	0.0	0.0	0.00	0.53	0.00	42.6
2	T1	All MCs	509	2.0	509	2.0	0.265	0.0	LOS A	0.0	0.0	0.00	0.00	0.00	49.8
Approach			510	2.0	510	2.0	0.265	0.0	NA	0.0	0.0	0.00	0.00	0.00	49.8
North: Hawkesbury Road (N)															
8	T1	All MCs	345	2.0	345	2.0	0.177	0.0	LOS A	0.0	0.0	0.00	0.00	0.00	49.8
9	R2	All MCs	1	0.0	1	0.0	0.001	6.9	LOS A	0.0	0.0	0.49	0.56	0.49	39.2
Approach			346	2.0	346	2.0	0.177	0.0	NA	0.0	0.0	0.00	0.00	0.00	49.8
West: Nolan Crescent															
10	L2	All MCs	1	0.0	1	0.0	0.004	8.5	LOS A	0.0	0.1	0.57	0.65	0.57	35.7
12	R2	All MCs	1	0.0	1	0.0	0.004	10.5	LOS A	0.0	0.1	0.57	0.65	0.57	38.2
Approach			2	0.0	2	0.0	0.004	9.5	LOS A	0.0	0.1	0.57	0.65	0.57	37.2
All Vehicles			858	2.0	858	2.0	0.265	0.1	NA	0.0	0.1	0.00	0.00	0.00	49.7

Site Level of Service (LOS) Method: Delay (RTA NSW). Site LOS Method is specified in the Network Data dialog (Override Site Data tab).

Vehicle movement LOS values are based on average delay per movement.

Minor Road Approach LOS values are based on average delay for all vehicle movements.

NA (TWSC): Level of Service is not defined for major road approaches or the intersection as a whole for Two-Way Sign Control (HCM LOS rule).

Two-Way Sign Control Capacity Model: SIDRA Standard.

Delay Model: SIDRA Standard (Control Delay: Geometric Delay is included).

Queue Model: SIDRA queue estimation methods are used for Back of Queue and Queue at Start of Gap.

Gap-Acceptance Capacity Formula: SIDRA Standard (Akçelik M3D).

HV (%) values are calculated for All Movement Classes of All Heavy Vehicle Model Designation.

Arrival Flows used in performance calculations are adjusted to include any Initial Queued Demand and Upstream Capacity Constraint effects.

SIDRA INTERSECTION 9.1 | Copyright © 2000-2023 Akcelik and Associates Pty Ltd | sidrasolutions.com

Organisation: SCT CONSULTING PTY LTD | Licence: NETWORK / 1PC | Processed: Wednesday, 18 October 2023 3:20:20 PM

Project: S:\Projects\SCT_00410_Cumberland Westmead Sth Transport Study\3. Technical Work Area\1. Network Optimisation\SCT_00410_Cumberland Westmead Sth_SIDRA_v0.5_upg2_sg0.9.sip9

MOVEMENT SUMMARY

Site: 15AM [HAW_CHU_23_15AM_DL (Site Folder: Network 1)]

Output produced by SIDRA INTERSECTION Version: 9.1.4.221

Network: N101 [Network 1 - AM (Network Folder: Base Year_DL)]

Hawkesbury Road and Church Avenue
7:30 AM to 8:30 AM base year demand
Site Category: Base Year
Give-Way (Two-Way)

Vehicle Movement Performance															
Mov ID	Turn	Mov Class	Demand Flows [Total HV]		Arrival Flows [Total HV]		Deg. Satn	Aver. Delay	Level of Service	95% Back Of Queue [Veh. Dist]		Prop. Que	Eff. Stop Rate	Aver. No. of Cycles	Aver. Speed
			veh/h	%	veh/h	%	v/c	sec		veh	m				km/h
South: Hawkesbury Road (S)															
1	L2	All MCs	1	0.0	1	0.0	0.250	4.6	LOS A	0.0	0.0	0.00	0.00	0.00	47.8
2	T1	All MCs	498	2.0	498	2.0	0.250	0.0	LOS A	0.0	0.0	0.00	0.00	0.00	49.8
Approach			499	2.0	499	2.0	0.250	0.0	NA	0.0	0.0	0.00	0.00	0.00	49.8
North: Hawkesbury Road (N)															
8	T1	All MCs	137	2.0	137	2.0	0.071	0.0	LOS A	0.0	0.0	0.00	0.00	0.00	49.7
9	R2	All MCs	1	0.0	1	0.0	0.001	5.9	LOS A	0.0	0.0	0.50	0.49	0.50	40.8
Approach			138	2.0	138	2.0	0.071	0.0	NA	0.0	0.0	0.00	0.00	0.00	49.2
West: Church Avenue															
10	L2	All MCs	1	0.0	1	0.0	0.004	7.6	LOS A	0.0	0.1	0.50	0.62	0.50	39.8
12	R2	All MCs	1	0.0	1	0.0	0.004	9.3	LOS A	0.0	0.1	0.50	0.62	0.50	39.8
Approach			2	0.0	2	0.0	0.004	8.5	LOS A	0.0	0.1	0.50	0.62	0.50	39.8
All Vehicles			640	2.0	639	2.0	0.250	0.1	NA	0.0	0.1	0.00	0.00	0.00	49.6

Site Level of Service (LOS) Method: Delay (RTA NSW). Site LOS Method is specified in the Network Data dialog (Override Site Data tab).

Vehicle movement LOS values are based on average delay per movement.

Minor Road Approach LOS values are based on average delay for all vehicle movements.

NA (TWSC): Level of Service is not defined for major road approaches or the intersection as a whole for Two-Way Sign Control (HCM LOS rule).

Two-Way Sign Control Capacity Model: SIDRA Standard.

Delay Model: SIDRA Standard (Control Delay: Geometric Delay is included).

Queue Model: SIDRA queue estimation methods are used for Back of Queue and Queue at Start of Gap.

Gap-Acceptance Capacity Formula: SIDRA Standard (Akçelik M3D).

HV (%) values are calculated for All Movement Classes of All Heavy Vehicle Model Designation.

Arrival Flows used in performance calculations are adjusted to include any Initial Queued Demand and Upstream Capacity Constraint effects.

SIDRA INTERSECTION 9.1 | Copyright © 2000-2023 Akcelik and Associates Pty Ltd | sidrasolutions.com

Organisation: SCT CONSULTING PTY LTD | Licence: NETWORK / 1PC | Processed: Wednesday, 18 October 2023 3:20:20 PM

Project: S:\Projects\SCT_00410_Cumberland Westmead Sth Transport Study\3. Technical Work Area\1. Network Optimisation\SCT_00410_Cumberland Westmead Sth_SIDRA_v0.5_upg2_sg0.9.sip9

MOVEMENT SUMMARY

Site: 20AM [HAW_AUS_23_20AM_DL (Site Folder: Network 1)]

Output produced by SIDRA INTERSECTION Version: 9.1.4.221

Network: N101 [Network 1 - AM (Network Folder: Base Year_DL)]

Hawkesbury Road and Church Avenue
7:30 AM to 8:30 AM base year demand
Site Category: Base Year
Give-Way (Two-Way)

Vehicle Movement Performance															
Mov ID	Turn	Mov Class	Demand Flows [Total HV]		Arrival Flows [Total HV]		Deg. Satn	Aver. Delay	Level of Service	95% Back Of Queue [Veh. Dist]		Prop. Que	Eff. Stop Rate	Aver. No. of Cycles	Aver. Speed
			veh/h	%	veh/h	%	v/c	sec		veh	m				km/h
South: Hawkesbury Road (S)															
1	L2	All MCs	1	0.0	1	0.0	0.229	4.6	LOS A	0.0	0.0	0.00	0.22	0.00	47.0
2	T1	All MCs	451	2.0	451	2.0	0.229	1.1	LOS A	0.0	0.0	0.00	0.22	0.00	41.6
Approach			452	2.0	452	2.0	0.229	1.1	NA	0.0	0.0	0.00	0.22	0.00	41.7
North: Hawkesbury Road (N)															
8	T1	All MCs	194	2.0	194	2.0	0.099	0.0	LOS A	0.0	0.1	0.01	0.00	0.01	39.8
9	R2	All MCs	1	0.0	1	0.0	0.099	3.8	LOS A	0.0	0.1	0.01	0.00	0.01	46.0
Approach			195	2.0	195	2.0	0.099	0.0	NA	0.0	0.1	0.01	0.00	0.01	40.0
West: Austral Avenue															
10	L2	All MCs	1	0.0	1	0.0	0.002	5.7	LOS A	0.0	0.0	0.39	0.54	0.39	43.7
12	R2	All MCs	1	0.0	1	0.0	0.002	5.6	LOS A	0.0	0.0	0.39	0.54	0.39	43.7
Approach			2	0.0	2	0.0	0.002	5.7	LOS A	0.0	0.0	0.39	0.54	0.39	43.7
All Vehicles			650	2.0	650	2.0	0.229	0.8	NA	0.0	0.1	0.00	0.16	0.00	41.0

Site Level of Service (LOS) Method: Delay (RTA NSW). Site LOS Method is specified in the Network Data dialog (Override Site Data tab).

Vehicle movement LOS values are based on average delay per movement.

Minor Road Approach LOS values are based on average delay for all vehicle movements.

NA (TWSC): Level of Service is not defined for major road approaches or the intersection as a whole for Two-Way Sign Control (HCM LOS rule).

Two-Way Sign Control Capacity Model: SIDRA Standard.

Delay Model: SIDRA Standard (Control Delay: Geometric Delay is included).

Queue Model: SIDRA queue estimation methods are used for Back of Queue and Queue at Start of Gap.

Gap-Acceptance Capacity Formula: SIDRA Standard (Akçelik M3D).

HV (%) values are calculated for All Movement Classes of All Heavy Vehicle Model Designation.

Arrival Flows used in performance calculations are adjusted to include any Initial Queued Demand and Upstream Capacity Constraint effects.

SIDRA INTERSECTION 9.1 | Copyright © 2000-2023 Akcelik and Associates Pty Ltd | sidrasolutions.com

Organisation: SCT CONSULTING PTY LTD | Licence: NETWORK / 1PC | Processed: Wednesday, 18 October 2023 3:20:20 PM

Project: S:\Projects\SCT_00410_Cumberland Westmead Sth Transport Study\3. Technical Work Area\1. Network Optimisation\SCT_00410_Cumberland Westmead Sth_SIDRA_v0.5_upg2_sg0.9.sip9

MOVEMENT SUMMARY

Site: 18AM [ALE_HAS_23_18AM_DL (Site Folder: Network 1)]

Output produced by SIDRA INTERSECTION Version: 9.1.4.221

Network: N101 [Network 1 - AM (Network Folder: Base Year_DL)]

Alexandra Avenue and Hassall Street (8:00 to 9:00 AM)

TCS 3894 SS 44

Site Category: Base Year

Signals - EQUISAT (Fixed-Time/SCATS) Coordinated Cycle Time = 110 seconds (Network Practical Cycle Time)

Vehicle Movement Performance															
Mov ID	Turn	Mov Class	Demand Flows [Total HV]		Arrival Flows [Total HV]		Deg. Satn	Aver. Delay	Level of Service	95% Back Of Queue [Veh. Dist]		Prop. Que	Eff. Stop Rate	Aver. No. of Cycles	Aver. Speed
			veh/h	%	veh/h	%	v/c	sec		veh	m				km/h
South: Hassall Street															
1	L2	All MCs	485	2.0	485	2.0	* 1.247	302.5	LOS F	65.5	466.7	1.00	1.71	2.80	1.1
3	R2	All MCs	324	2.0	324	2.0	1.243	303.9	LOS F	43.0	306.5	1.00	1.67	2.83	6.6
Approach			809	2.0	809	2.0	1.247	303.1	LOS F	65.5	466.7	1.00	1.69	2.81	3.2
East: Alexandra Avenue (E)															
4	L2	All MCs	59	2.0	59	2.0	0.039	7.2	LOS A	0.5	3.7	0.18	0.61	0.18	47.0
5	T1	All MCs	648	2.0	648	2.0	* 1.229	257.8	LOS F	84.2	599.5	1.00	2.23	2.68	6.4
Approach			707	2.0	707	2.0	1.229	236.7	LOS F	84.2	599.5	0.93	2.09	2.47	7.0
West: Alexandra Avenue (W)															
11	T1	All MCs	288	14.4	288	14.4	0.152	20.7	LOS B	7.1	55.7	0.77	0.48	0.77	39.3
12	R2	All MCs	1	0.0	1	0.0	0.152	112.5	LOS F	7.1	55.7	1.00	0.51	1.00	18.7
Approach			289	14.4	289	14.4	0.152	21.0	LOS B	7.1	55.7	0.77	0.48	0.77	39.3
All Vehicles			1805	4.0	1805	4.0	1.247	231.9	LOS F	84.2	599.5	0.94	1.66	2.35	6.1

Site Level of Service (LOS) Method: Delay (RTA NSW). Site LOS Method is specified in the Network Data dialog (Override Site Data tab).

Vehicle movement LOS values are based on average delay per movement.

Intersection and Approach LOS values are based on average delay for all vehicle movements.

Delay Model: SIDRA Standard (Control Delay: Geometric Delay is included).

Queue Model: SIDRA queue estimation methods are used for Back of Queue and Queue at Start of Green.

Gap-Acceptance Capacity Formula: SIDRA Standard (Akçelik M3D).

HV (%) values are calculated for All Movement Classes of All Heavy Vehicle Model Designation.

Arrival Flows used in performance calculations are adjusted to include any Initial Queued Demand and Upstream Capacity Constraint effects.

* Critical Movement (Signal Timing)

Pedestrian Movement Performance											
Mov ID	Crossing	Dem. Flow ped/h	Aver. Delay sec	Level of Service	AVERAGE BACK OF QUEUE [Ped Dist]		Prop. Que	Eff. Stop Rate	Travel Time sec	Travel Dist. m	Aver. Speed m/sec
South: Hassall Street											
P1	Full	446	50.1	LOS E	1.3	1.3	0.96	0.96	203.9	200.0	0.98
West: Alexandra Avenue (W)											
P4	Full	221	49.6	LOS E	0.7	0.7	0.95	0.95	203.5	200.0	0.98
All Pedestrians		667	49.9	LOS E	1.3	1.3	0.96	0.96	203.8	200.0	0.98

Level of Service (LOS) Method: SIDRA Pedestrian LOS Method (Based on Average Delay)
 Pedestrian movement LOS values are based on average delay per pedestrian movement.
 Intersection LOS value for Pedestrians is based on average delay for all pedestrian movements.

CCG MOVEMENT SUMMARY

Common Control Group: CCG1 [TCS 1571]

Output produced by SIDRA INTERSECTION Version: 9.1.4.221

Network: N101 [Network 1 - PM (Network Folder: Base Year_DL)]

EQUISAT (Fixed-Time/SCATS) Coordinated Cycle Time = 110 seconds (Network Practical Cycle Time)

Vehicle Movement Performance (CCG)															
Mov ID	Turn	Mov Class	Demand Flows [Total HV]		Arrival Flows [Total HV]		Deg. Satn	Aver. Delay	Level of Service	Aver. Back Of Queue [Veh. Dist]		Prop. Que	Eff. Stop Rate	Aver. No. of Cycles	Aver. Speed
			veh/h	%	veh/h	%	v/c	sec		veh	m				km/h
Site: 14PM [HAW_RAI_23_14PM_DL]															
South: Hawkesbury Road (S)															
2	T1	All MCs	470	2.0	470	2.0	0.356	3.6	LOS A	2.8	20.0	0.20	0.36	0.20	35.2
3	R2	All MCs	455	2.0	455	2.0	0.558	14.4	LOS A	6.3	44.5	0.52	0.80	0.52	32.7
Approach			925	2.0	925	2.0	0.558	8.9	LOS A	6.3	44.5	0.36	0.58	0.36	33.2
East: Railway Parade															
4	L2	All MCs	105	2.0	105	2.0	0.144	18.3	LOS B	2.2	15.3	0.67	0.58	0.67	30.2
6	R2	All MCs	16	2.0	16	2.0	0.057	46.3	LOS D	0.4	3.2	0.88	0.67	0.88	23.7
Approach			121	2.0	121	2.0	0.144	22.0	LOS B	2.2	15.3	0.70	0.59	0.70	29.0
North: Hawkesbury Road (N)															
7	L2	All MCs	123	2.0	123	2.0	0.385	42.0	LOS C	4.2	34.6	0.88	0.77	0.88	24.9
8	T1	All MCs	450	8.4	450	8.4	0.515	36.1	LOS C	7.8	55.5	0.89	0.75	0.89	10.4
Approach			573	7.1	573	7.1	0.515	37.4	LOS C	7.8	55.5	0.89	0.76	0.89	15.9
All Vehicles			1619	3.8	1619	3.8	0.558	20.0	LOS B	7.8	55.5	0.57	0.64	0.57	25.9
Site: 13PM [HAW_ALE_23_13PM_DL]															
South: Hawkesbury Road (S)															
1	L2	All MCs	1	0.0	1	0.0	0.777	57.4	LOS E	8.6	61.1	1.00	0.94	1.12	25.8
2	T1	All MCs	428	2.0	428	2.0	0.777	51.7	LOS D	8.6	61.1	1.00	0.95	1.14	10.5
Approach			429	2.0	429	2.0	0.777	51.7	LOS D	8.6	61.1	1.00	0.95	1.14	10.5
East: Alexandra Avenue (E)															
4	L2	All MCs	1	1.7	1	1.7	1.194	236.9	LOS F	21.5	153.0	1.00	2.13	2.47	2.6
5	T1	All MCs	814	2.0	814	2.0	* 1.194	228.7	LOS F	21.5	153.0	1.00	2.13	2.47	10.1
6	R2	All MCs	379	2.0	379	2.0	0.863	53.3	LOS D	13.8	98.5	1.00	1.00	1.21	9.7

Approach			1194	2.0	1194	2.0	1.194	173.0	LOS F	21.5	153.0	1.00	1.77	2.07	10.1
North: Hawkesbury Road (N)															
7	L2	All MCs	312	11.3	312	11.3	0.752	44.3	LOS D	7.7	55.0	0.97	0.85	1.03	5.0
8	T1	All MCs	183	2.0	183	2.0	0.752	29.6	LOS C	7.7	55.0	0.79	0.81	0.81	7.8
9	R2	All MCs	60	2.0	60	2.0	* 0.714	33.6	LOS C	5.2	37.2	0.76	0.80	0.78	32.5
Approach			555	7.2	555	7.2	0.752	38.3	LOS C	7.7	55.0	0.89	0.83	0.93	10.4
West: Alexandra Avenue (W)															
10	L2	All MCs	118	2.0	118	2.0	0.302	24.3	LOS B	2.0	14.2	0.85	0.76	0.85	32.8
11	T1	All MCs	36	1.9	36	1.9	0.092	38.6	LOS C	1.0	6.8	0.85	0.63	0.85	27.3
Approach			154	2.0	154	2.0	0.302	27.7	LOS B	2.0	14.2	0.85	0.73	0.85	31.3
All Vehicles			2333	3.2	2333	3.2	1.194	109.0	LOS F	21.5	153.0	0.96	1.33	1.55	10.9

Site Level of Service (LOS) Method: Delay (RTA NSW). Site LOS Method is specified in the Network Data dialog (Override Site Data tab).

Vehicle movement LOS values are based on average delay per movement.

Intersection and Approach LOS values are based on average delay for all vehicle movements.

Delay Model: SIDRA Standard (Control Delay: Geometric Delay is included).

Gap-Acceptance Capacity Formula: SIDRA Standard (Akçelik M3D).

HV (%) values are calculated for All Movement Classes of All Heavy Vehicle Model Designation.

Arrival Flows used in performance calculations are adjusted to include any Initial Queued Demand and Upstream Capacity Constraint effects.

* Critical Movement (Signal Timing)

Pedestrian Movement Performance (CCG)												
Mov ID	Crossing	Dem. Flow ped/h	Aver. Delay sec	Level of Service	AVERAGE BACK OF QUEUE [Ped Dist]		Prop. Que	Eff. Stop Rate	Travel Time sec	Travel Dist. m	Aver. Speed m/sec	
Site: 14PM [HAW_RAI_23_14PM_DL]												
South: Hawkesbury Road (S)												
P1	Full	676	50.6	LOS E	2.1	2.1	0.97	0.97	204.4	200.0	0.98	
East: Railway Parade												
P2	Full	2544	55.0	LOS E	8.4	8.4	1.06	1.06	208.8	200.0	0.96	
North: Hawkesbury Road (N)												
P3	Full	713	50.7	LOS E	2.2	2.2	0.97	0.97	204.5	200.0	0.98	
All Pedestrians		3933	53.5	LOS E	8.4	8.4	1.03	1.03	207.3	200.0	0.96	
Site: 13PM [HAW_ALE_23_13PM_DL]												

South: Hawkesbury Road (S)											
P1	Full	1353	52.1	LOS E	4.2	4.2	1.00	1.00	205.9	200.0	0.97
East: Alexandra Avenue (E)											
P2	Full	3322	57.1	LOS E	11.4	11.4	1.10	1.10	210.9	200.0	0.95
West: Alexandra Avenue (W)											
P4	Full	183	49.5	LOS E	0.5	0.5	0.95	0.95	203.4	200.0	0.98
All Pedestrians		4858	55.4	LOS E	11.4	11.4	1.07	1.07	209.2	200.0	0.96

Level of Service (LOS) Method: SIDRA Pedestrian LOS Method (Based on Average Delay)
 Pedestrian movement LOS values are based on average delay per pedestrian movement.
 Intersection LOS value for Pedestrians is based on average delay for all pedestrian movements.

MOVEMENT SUMMARY

Site: 12PM [HAW_PRI_23_12PM_DL (Site Folder: Network 1)]

Output produced by SIDRA INTERSECTION Version: 9.1.4.221

Network: N101 [Network 1 - PM (Network Folder: Base Year_DL)]

TCS 1583 SS 44

5:00 PM to 6:00 PM Base year demand

Site Category: Base Year

Signals - EQUISAT (Fixed-Time/SCATS) Isolated Cycle Time = 66 seconds (Site User-Given Phase Times)

Vehicle Movement Performance															
Mov ID	Turn	Mov Class	Demand Flows [Total HV]		Arrival Flows [Total HV]		Deg. Satn	Aver. Delay	Level of Service	Aver. Back Of Queue [Veh. Dist]		Prop. Que	Eff. Stop Rate	Aver. No. of Cycles	Aver. Speed
			veh/h	%	veh/h	%	v/c	sec		veh	m				km/h
South: Hawkesbury Road (S)															
2	T1	All MCs	209	2.0	209	2.0	0.153	2.9	LOS A	1.3	8.9	0.33	0.27	0.33	38.6
3	R2	All MCs	125	2.0	125	2.0	* 2.294	1211.7	LOS F	17.1	122.0	1.00	2.81	8.76	0.7
Approach			334	2.0	334	2.0	2.294	454.0	LOS F	17.1	122.0	0.58	1.22	3.47	1.4
East: Priddle Street															
4	L2	All MCs	1	0.0	1	0.0	0.002	24.8	LOS B	0.0	0.1	0.77	0.58	0.77	14.0
6	R2	All MCs	1	0.0	1	0.0	0.003	28.4	LOS B	0.0	0.1	0.83	0.59	0.83	12.6
Approach			2	0.0	2	0.0	0.003	26.6	LOS B	0.0	0.1	0.80	0.58	0.80	13.2
North: Hawkesbury Road (N)															
7	L2	All MCs	142	2.0	142	2.0	0.127	10.5	LOS A	1.2	8.5	0.45	0.66	0.45	32.4
8	T1	All MCs	214	2.0	214	2.0	* 0.187	6.2	LOS A	1.9	13.3	0.47	0.40	0.47	34.9
Approach			357	2.0	357	2.0	0.187	7.9	LOS A	1.9	13.3	0.46	0.50	0.46	33.6
All Vehicles			693	2.0	693	2.0	2.294	223.1	LOS F	17.1	122.0	0.52	0.85	1.92	3.2

Site Level of Service (LOS) Method: Delay (RTA NSW). Site LOS Method is specified in the Network Data dialog (Override Site Data tab).

Vehicle movement LOS values are based on average delay per movement.

Intersection and Approach LOS values are based on average delay for all vehicle movements.

Delay Model: SIDRA Standard (Control Delay: Geometric Delay is included).

Queue Model: SIDRA queue estimation methods are used for Back of Queue and Queue at Start of Green.

Gap-Acceptance Capacity Formula: SIDRA Standard (Akçelik M3D).

HV (%) values are calculated for All Movement Classes of All Heavy Vehicle Model Designation.

Arrival Flows used in performance calculations are adjusted to include any Initial Queued Demand and Upstream Capacity Constraint effects.

* Critical Movement (Signal Timing)

Pedestrian Movement Performance											
Mov ID	Crossing	Dem. Flow ped/h	Aver. Delay sec	Level of Service	AVERAGE BACK OF QUEUE [Ped Dist]		Prop. Que	Eff. Stop Rate	Travel Time sec	Travel Dist. m	Aver. Speed m/sec
South: Hawkesbury Road (S)											
P1	Full	211	27.5	LOS C	0.4	0.4	0.92	0.92	181.4	200.0	1.10
East: Priddle Street											
P2	Full	211	27.5	LOS C	0.4	0.4	0.92	0.92	181.4	200.0	1.10
North: Hawkesbury Road (N)											
P3	Full	211	27.5	LOS C	0.4	0.4	0.92	0.92	181.4	200.0	1.10
All Pedestrians		632	27.5	LOS C	0.4	0.4	0.92	0.92	181.4	200.0	1.10

Level of Service (LOS) Method: SIDRA Pedestrian LOS Method (Based on Average Delay)
 Pedestrian movement LOS values are based on average delay per pedestrian movement.
 Intersection LOS value for Pedestrians is based on average delay for all pedestrian movements.

SIDRA INTERSECTION 9.1 | Copyright © 2000-2023 Akcelik and Associates Pty Ltd | sidrasolutions.com

Organisation: SCT CONSULTING PTY LTD | Licence: NETWORK / 1PC | Processed: Wednesday, 18 October 2023 3:20:27 PM

Project: S:\Projects\SCT_00410_Cumberland Westmead Sth Transport Study\3. Technical Work Area\1. Network Optimisation\SCT_00410_Cumberland Westmead Sth_SIDRA_v0.5_upg2_sg0.9.sip9

MOVEMENT SUMMARY

Site: 22PM [HAW_NOL_23_22PM_DL (Site Folder: Network 1)]

Output produced by SIDRA INTERSECTION Version: 9.1.4.221

Network: N101 [Network 1 - PM (Network Folder: Base Year_DL)]

Hawkesbury Road and Nolan Crescent
 5:00 PM to 6:00 PM Base year demand
 Site Category: Base Year
 Give-Way (Two-Way)

Vehicle Movement Performance															
Mov ID	Turn	Mov Class	Demand Flows [Total HV]		Arrival Flows [Total HV]		Deg. Satn	Aver. Delay	Level of Service	Aver. Back Of Queue [Veh. Dist]		Prop. Que	Eff. Stop Rate	Aver. No. of Cycles	Aver. Speed
			veh/h	%	veh/h	%	v/c	sec		veh	m				km/h
South: Hawkesbury Road (S)															
1	L2	All MCs	1	0.0	1	0.0	0.001	4.6	LOS A	0.0	0.0	0.00	0.53	0.00	42.6
2	T1	All MCs	369	2.0	369	2.0	0.193	0.0	LOS A	0.0	0.0	0.00	0.00	0.00	49.9
Approach			370	2.0	370	2.0	0.193	0.0	NA	0.0	0.0	0.00	0.00	0.00	49.9
North: Hawkesbury Road (N)															
8	T1	All MCs	389	2.0	389	2.0	0.200	0.0	LOS A	0.0	0.0	0.00	0.00	0.00	49.9
9	R2	All MCs	1	0.0	1	0.0	0.001	6.1	LOS A	0.0	0.0	0.42	0.53	0.42	40.1
Approach			390	2.0	390	2.0	0.200	0.0	NA	0.0	0.0	0.00	0.00	0.00	49.9
West: Nolan Crescent															
10	L2	All MCs	1	0.0	1	0.0	0.003	5.7	LOS A	0.0	0.0	0.47	0.56	0.47	38.7
12	R2	All MCs	1	0.0	1	0.0	0.003	8.1	LOS A	0.0	0.0	0.47	0.56	0.47	40.3
Approach			2	0.0	2	0.0	0.003	6.9	LOS A	0.0	0.0	0.47	0.56	0.47	39.7
All Vehicles			763	2.0	763	2.0	0.200	0.1	NA	0.0	0.0	0.00	0.00	0.00	49.8

Site Level of Service (LOS) Method: Delay (RTA NSW). Site LOS Method is specified in the Network Data dialog (Override Site Data tab).

Vehicle movement LOS values are based on average delay per movement.

Minor Road Approach LOS values are based on average delay for all vehicle movements.

NA (TWSC): Level of Service is not defined for major road approaches or the intersection as a whole for Two-Way Sign Control (HCM LOS rule).

Two-Way Sign Control Capacity Model: SIDRA Standard.

Delay Model: SIDRA Standard (Control Delay: Geometric Delay is included).

Queue Model: SIDRA queue estimation methods are used for Back of Queue and Queue at Start of Gap.

Gap-Acceptance Capacity Formula: SIDRA Standard (Akçelik M3D).

HV (%) values are calculated for All Movement Classes of All Heavy Vehicle Model Designation.

Arrival Flows used in performance calculations are adjusted to include any Initial Queued Demand and Upstream Capacity Constraint effects.

SIDRA INTERSECTION 9.1 | Copyright © 2000-2023 Akcelik and Associates Pty Ltd | sidrasolutions.com

Organisation: SCT CONSULTING PTY LTD | Licence: NETWORK / 1PC | Processed: Wednesday, 18 October 2023 3:20:27 PM

Project: S:\Projects\SCT_00410_Cumberland Westmead Sth Transport Study\3. Technical Work Area\1. Network Optimisation\SCT_00410_Cumberland Westmead Sth_SIDRA_v0.5_upg2_sg0.9.sip9

MOVEMENT SUMMARY

Site: 15PM [HAW_CHU_23_15PM_DL (Site Folder: Network 1)]

Output produced by SIDRA INTERSECTION Version: 9.1.4.221

Network: N101 [Network 1 - PM (Network Folder: Base Year_DL)]

Hawkesbury Road and Church Avenue
 5:00 PM to 6:00 PM Base year demand
 Site Category: Base Year
 Give-Way (Two-Way)

Vehicle Movement Performance															
Mov ID	Turn	Mov Class	Demand Flows [Total HV]		Arrival Flows [Total HV]		Deg. Satn	Aver. Delay	Level of Service	Aver. Back Of Queue [Veh. Dist]		Prop. Que	Eff. Stop Rate	Aver. No. of Cycles	Aver. Speed
			veh/h	%	veh/h	%	v/c	sec		veh	m				km/h
South: Hawkesbury Road (S)															
1	L2	All MCs	1	0.0	1	0.0	0.174	4.6	LOS A	0.0	0.0	0.00	0.00	0.00	47.8
2	T1	All MCs	347	2.0	347	2.0	0.174	0.0	LOS A	0.0	0.0	0.00	0.00	0.00	49.9
Approach			348	2.0	348	2.0	0.174	0.0	NA	0.0	0.0	0.00	0.00	0.00	49.8
North: Hawkesbury Road (N)															
8	T1	All MCs	157	2.0	157	2.0	0.082	0.0	LOS A	0.0	0.0	0.00	0.00	0.00	50.0
9	R2	All MCs	1	0.0	1	0.0	0.001	5.4	LOS A	0.0	0.0	0.41	0.47	0.41	41.1
Approach			158	2.0	158	2.0	0.082	0.0	NA	0.0	0.0	0.00	0.00	0.00	49.5
West: Church Avenue															
10	L2	All MCs	1	0.0	1	0.0	0.002	5.4	LOS A	0.0	0.0	0.39	0.52	0.39	42.2
12	R2	All MCs	1	0.0	1	0.0	0.002	6.1	LOS A	0.0	0.0	0.39	0.52	0.39	42.2
Approach			2	0.0	2	0.0	0.002	5.7	LOS A	0.0	0.0	0.39	0.52	0.39	42.2
All Vehicles			508	2.0	508	2.0	0.174	0.1	NA	0.0	0.0	0.00	0.00	0.00	49.6

Site Level of Service (LOS) Method: Delay (RTA NSW). Site LOS Method is specified in the Network Data dialog (Override Site Data tab).

Vehicle movement LOS values are based on average delay per movement.

Minor Road Approach LOS values are based on average delay for all vehicle movements.

NA (TWSC): Level of Service is not defined for major road approaches or the intersection as a whole for Two-Way Sign Control (HCM LOS rule).

Two-Way Sign Control Capacity Model: SIDRA Standard.

Delay Model: SIDRA Standard (Control Delay: Geometric Delay is included).

Queue Model: SIDRA queue estimation methods are used for Back of Queue and Queue at Start of Gap.

Gap-Acceptance Capacity Formula: SIDRA Standard (Akçelik M3D).

HV (%) values are calculated for All Movement Classes of All Heavy Vehicle Model Designation.

Arrival Flows used in performance calculations are adjusted to include any Initial Queued Demand and Upstream Capacity Constraint effects.

SIDRA INTERSECTION 9.1 | Copyright © 2000-2023 Akcelik and Associates Pty Ltd | sidrasolutions.com

Organisation: SCT CONSULTING PTY LTD | Licence: NETWORK / 1PC | Processed: Wednesday, 18 October 2023 3:20:27 PM

Project: S:\Projects\SCT_00410_Cumberland Westmead Sth Transport Study\3. Technical Work Area\1. Network Optimisation\SCT_00410_Cumberland Westmead Sth_SIDRA_v0.5_upg2_sg0.9.sip9

MOVEMENT SUMMARY

Site: 20PM [HAW_AUS_23_20PM_DL (Site Folder: Network 1)]

Output produced by SIDRA INTERSECTION Version: 9.1.4.221

Network: N101 [Network 1 - PM (Network Folder: Base Year_DL)]

Hawkesbury Road and Church Avenue
 5:00 PM to 6:00 PM Base year demand
 Site Category: Base Year
 Give-Way (Two-Way)

Vehicle Movement Performance															
Mov ID	Turn	Mov Class	Demand Flows [Total HV]		Arrival Flows [Total HV]		Deg. Satn	Aver. Delay	Level of Service	Aver. Back Of Queue [Veh. Dist]		Prop. Que	Eff. Stop Rate	Aver. No. of Cycles	Aver. Speed
			veh/h	%	veh/h	%	v/c	sec		veh	m				km/h
South: Hawkesbury Road (S)															
1	L2	All MCs	1	0.0	1	0.0	0.170	4.6	LOS A	0.0	0.0	0.00	0.22	0.00	47.0
2	T1	All MCs	334	2.0	334	2.0	0.170	1.1	LOS A	0.0	0.0	0.00	0.22	0.00	41.6
Approach			335	2.0	335	2.0	0.170	1.1	NA	0.0	0.0	0.00	0.22	0.00	41.7
North: Hawkesbury Road (N)															
8	T1	All MCs	286	2.0	286	2.0	0.146	0.0	LOS A	0.0	0.0	0.00	0.00	0.00	39.9
9	R2	All MCs	1	0.0	1	0.0	0.146	3.6	LOS A	0.0	0.0	0.00	0.00	0.00	46.0
Approach			287	2.0	287	2.0	0.146	0.0	NA	0.0	0.0	0.00	0.00	0.00	40.0
West: Austral Avenue															
10	L2	All MCs	1	0.0	1	0.0	0.002	6.3	LOS A	0.0	0.0	0.39	0.55	0.39	43.7
12	R2	All MCs	1	0.0	1	0.0	0.002	6.0	LOS A	0.0	0.0	0.39	0.55	0.39	43.7
Approach			2	0.0	2	0.0	0.002	6.1	LOS A	0.0	0.0	0.39	0.55	0.39	43.7
All Vehicles			624	2.0	624	2.0	0.170	0.6	NA	0.0	0.0	0.00	0.12	0.00	40.7

Site Level of Service (LOS) Method: Delay (RTA NSW). Site LOS Method is specified in the Network Data dialog (Override Site Data tab).

Vehicle movement LOS values are based on average delay per movement.

Minor Road Approach LOS values are based on average delay for all vehicle movements.

NA (TWSC): Level of Service is not defined for major road approaches or the intersection as a whole for Two-Way Sign Control (HCM LOS rule).

Two-Way Sign Control Capacity Model: SIDRA Standard.

Delay Model: SIDRA Standard (Control Delay: Geometric Delay is included).

Queue Model: SIDRA queue estimation methods are used for Back of Queue and Queue at Start of Gap.

Gap-Acceptance Capacity Formula: SIDRA Standard (Akçelik M3D).

HV (%) values are calculated for All Movement Classes of All Heavy Vehicle Model Designation.

Arrival Flows used in performance calculations are adjusted to include any Initial Queued Demand and Upstream Capacity Constraint effects.

SIDRA INTERSECTION 9.1 | Copyright © 2000-2023 Akcelik and Associates Pty Ltd | sidrasolutions.com

Organisation: SCT CONSULTING PTY LTD | Licence: NETWORK / 1PC | Processed: Wednesday, 18 October 2023 3:20:27 PM

Project: S:\Projects\SCT_00410_Cumberland Westmead Sth Transport Study\3. Technical Work Area\1. Network Optimisation\SCT_00410_Cumberland Westmead Sth_SIDRA_v0.5_upg2_sg0.9.sip9

MOVEMENT SUMMARY

Site: 18PM [ALE_HAS_23_18PM_DL (Site Folder: Network 1)]

Output produced by SIDRA INTERSECTION Version: 9.1.4.221

Network: N101 [Network 1 - PM (Network Folder: Base Year_DL)]

Alexandra Avenue and Hassall Street (5:00 to 6:00 PM)

TCS 3894 SS 44

Site Category: Base Year

Signals - EQUISAT (Fixed-Time/SCATS) Coordinated Cycle Time = 110 seconds (Network Practical Cycle Time)

Vehicle Movement Performance															
Mov ID	Turn	Mov Class	Demand Flows [Total HV]		Arrival Flows [Total HV]		Deg. Satn	Aver. Delay	Level of Service	Aver. Back Of Queue [Veh. Dist]		Prop. Que	Eff. Stop Rate	Aver. No. of Cycles	Aver. Speed
			veh/h	%	veh/h	%	v/c	sec		veh	m				km/h
South: Hassall Street															
1	L2	All MCs	408	2.0	408	2.0	* 0.795	65.3	LOS E	12.9	92.1	0.97	0.90	1.05	6.4
3	R2	All MCs	139	2.0	139	2.0	0.430	68.5	LOS E	4.0	28.8	0.92	0.79	0.92	24.8
Approach			546	2.0	546	2.0	0.795	66.1	LOS E	12.9	92.1	0.95	0.87	1.02	9.7
East: Alexandra Avenue (E)															
4	L2	All MCs	189	2.0	189	2.0	0.129	8.1	LOS A	1.4	9.6	0.24	0.64	0.24	45.9
5	T1	All MCs	849	2.0	849	2.0	* 0.809	22.1	LOS B	22.7	161.6	0.88	0.81	0.89	34.9
Approach			1039	2.0	1039	2.0	0.809	19.6	LOS B	22.7	161.6	0.76	0.78	0.77	36.7
West: Alexandra Avenue (W)															
11	T1	All MCs	363	10.4	363	10.4	0.148	8.2	LOS A	3.0	22.6	0.47	0.35	0.47	49.6
12	R2	All MCs	1	0.0	1	0.0	0.148	51.4	LOS D	3.0	22.6	0.56	0.37	0.56	31.6
Approach			364	10.4	364	10.4	0.148	8.3	LOS A	3.0	22.6	0.47	0.35	0.47	49.6
All Vehicles			1949	3.6	1949	3.6	0.809	30.5	LOS C	22.7	161.6	0.76	0.73	0.78	28.4

Site Level of Service (LOS) Method: Delay (RTA NSW). Site LOS Method is specified in the Network Data dialog (Override Site Data tab).

Vehicle movement LOS values are based on average delay per movement.

Intersection and Approach LOS values are based on average delay for all vehicle movements.

Delay Model: SIDRA Standard (Control Delay: Geometric Delay is included).

Queue Model: SIDRA queue estimation methods are used for Back of Queue and Queue at Start of Green.

Gap-Acceptance Capacity Formula: SIDRA Standard (Akçelik M3D).

HV (%) values are calculated for All Movement Classes of All Heavy Vehicle Model Designation.

Arrival Flows used in performance calculations are adjusted to include any Initial Queued Demand and Upstream Capacity Constraint effects.

* Critical Movement (Signal Timing)

Pedestrian Movement Performance											
Mov ID	Crossing	Dem. Flow ped/h	Aver. Delay sec	Level of Service	AVERAGE BACK OF QUEUE [Ped Dist]		Prop. Que	Eff. Stop Rate	Travel Time sec	Travel Dist. m	Aver. Speed m/sec
South: Hassall Street											
P1	Full	418	50.0	LOS E	1.3	1.3	0.96	0.96	203.9	200.0	0.98
West: Alexandra Avenue (W)											
P4	Full	206	49.6	LOS E	0.6	0.6	0.95	0.95	203.4	200.0	0.98
All Pedestrians		624	49.9	LOS E	1.3	1.3	0.96	0.96	203.7	200.0	0.98

Level of Service (LOS) Method: SIDRA Pedestrian LOS Method (Based on Average Delay)
 Pedestrian movement LOS values are based on average delay per pedestrian movement.
 Intersection LOS value for Pedestrians is based on average delay for all pedestrian movements.

MOVEMENT SUMMARY

Site: 21AM [BRI_MON_23_21AM_DL (Site Folder: Network 2)]

Output produced by SIDRA INTERSECTION Version: 9.1.4.221

Network: N101 [Network 2 - AM - Roundabout (Network Folder: Base Year_DL)]

Bridge Road and Entry to Monarco (8:00 to 9:00 AM)

Site Category: Base Year

Roundabout

Vehicle Movement Performance															
Mov ID	Turn	Mov Class	Demand Flows		Arrival Flows		Deg. Satn	Aver. Delay	Level of Service	Aver. Back Of Queue		Prop. Que	Eff. Stop Rate	Aver. No. of Cycles	Aver. Speed
			[Total	HV]	[Total	HV]				[Veh.	Dist]				
			veh/h	%	veh/h	%	v/c	sec		veh	m				km/h
South: Bridge Road (S)															
2	T1	All MCs	764	2.0	764	2.0	0.466	3.9	LOS A	1.2	8.9	0.04	0.45	0.04	42.5
3	R2	All MCs	1	0.0	1	0.0	0.466	6.5	LOS A	1.2	8.9	0.04	0.45	0.04	38.3
3u	U	All MCs	1	0.0	1	0.0	0.466	7.8	LOS A	1.2	8.9	0.04	0.45	0.04	35.2
Approach			766	2.0	766	2.0	0.466	3.9	LOS A	1.2	8.9	0.04	0.45	0.04	42.5
East: Monarco Entry															
4	L2	All MCs	1	0.0	1	0.0	0.003	6.0	LOS A	0.0	0.0	0.42	0.59	0.42	30.9
6	R2	All MCs	1	0.0	1	0.0	0.003	8.1	LOS A	0.0	0.0	0.42	0.59	0.42	38.7
6u	U	All MCs	1	0.0	1	0.0	0.003	9.4	LOS A	0.0	0.0	0.42	0.59	0.42	35.1
Approach			3	0.0	3	0.0	0.003	7.8	LOS A	0.0	0.0	0.42	0.59	0.42	35.8
North: Bridge Road (N)															
7	L2	All MCs	1	0.0	1	0.0	0.230	4.8	LOS A	0.3	2.1	0.02	0.46	0.02	42.2
8	T1	All MCs	371	2.0	371	2.0	0.230	3.9	LOS A	0.3	2.1	0.02	0.46	0.02	42.7
9u	U	All MCs	1	0.0	1	0.0	0.230	7.8	LOS A	0.3	2.1	0.02	0.46	0.02	43.9
Approach			373	2.0	373	2.0	0.230	3.9	LOS A	0.3	2.1	0.02	0.46	0.02	42.7
All Vehicles			1143	2.0	1143	2.0	0.466	3.9	LOS A	1.2	8.9	0.03	0.45	0.03	42.6

Site Level of Service (LOS) Method: Delay (RTA NSW). Site LOS Method is specified in the Network Data dialog (Override Site Data tab).

Vehicle movement LOS values are based on average delay per movement.

Intersection and Approach LOS values are based on average delay for all vehicle movements.

Roundabout Capacity Model: SIDRA Standard.

Delay Model: SIDRA Standard (Control Delay: Geometric Delay is included).

Queue Model: SIDRA queue estimation methods are used for Back of Queue and Queue at Start of Gap.

Gap-Acceptance Capacity Formula: SIDRA Standard (Akçelik M3D).

HV (%) values are calculated for All Movement Classes of All Heavy Vehicle Model Designation.

Arrival Flows used in performance calculations are adjusted to include any Initial Queued Demand and Upstream Capacity Constraint effects.

SIDRA INTERSECTION 9.1 | Copyright © 2000-2023 Akcelik and Associates Pty Ltd | sidrasolutions.com

Organisation: SCT CONSULTING PTY LTD | Licence: NETWORK / 1PC | Processed: Thursday, 19 October 2023 3:10:11 PM

Project: S:\Projects\SCT_00410_Cumberland Westmead Sth Transport Study\3. Technical Work Area\1. Network Optimisation\SCT_00410_Cumberland Westmead Sth_SIDRA_v0.5_upg2_sg0.9.sip9

MOVEMENT SUMMARY

Site: 24AMe [BRI_ALE_23_24AM_DL (Site Folder: Network 2)]

Output produced by SIDRA INTERSECTION Version: 9.1.4.221

Network: N101 [Network 2 - AM - Roundabout (Network Folder: Base Year_DL)]

Bridge Road and Alexandra Avenue (8:00 to 9:00 AM)

Site Category: Base Year

Roundabout

Vehicle Movement Performance															
Mov ID	Turn	Mov Class	Demand Flows		Arrival Flows		Deg. Satn	Aver. Delay	Level of Service	Aver. Back Of Queue		Prop. Que	Eff. Stop Rate	Aver. No. of Cycles	Aver. Speed
			[Total	HV]	[Total	HV]				[Veh.	Dist]				
			veh/h	%	veh/h	%	v/c	sec		veh	m				
South: Bridge Road (S)															
2	T1	All MCs	275	2.0	275	2.0	0.608	7.6	LOS A	1.7	12.3	0.65	0.85	0.74	20.2
3	R2	All MCs	203	2.0	203	2.0	0.608	10.6	LOS A	1.7	12.3	0.65	0.85	0.74	41.1
3u	U	All MCs	6	0.0	6	0.0	0.608	11.9	LOS A	1.7	12.3	0.65	0.85	0.74	20.2
Approach			485	2.0	485	2.0	0.608	8.9	LOS A	1.7	12.3	0.65	0.85	0.74	35.9
East: Alexandra Avenue															
4	L2	All MCs	278	2.0	278	2.0	0.940	22.1	LOS B	7.9	55.5	1.00	1.36	2.11	33.3
6	R2	All MCs	548	0.0	548	0.0	0.940	24.2	LOS B	7.9	55.5	1.00	1.36	2.11	33.3
6u	U	All MCs	1	0.0	1	0.0	0.940	25.6	LOS B	7.9	55.5	1.00	1.36	2.11	39.1
Approach			826	0.7	826	0.7	0.940	23.5	LOS B	7.9	55.5	1.00	1.36	2.11	33.3
North: Bridge Road (N)															
7	L2	All MCs	1	0.0	1	0.0	0.525	5.7	LOS A	1.8	13.0	0.60	0.52	0.60	43.3
8	T1	All MCs	572	2.0	572	2.0	0.525	5.4	LOS A	1.8	13.0	0.60	0.52	0.60	29.9
9u	U	All MCs	1	0.0	1	0.0	0.525	9.7	LOS A	1.8	13.0	0.60	0.52	0.60	29.9
Approach			574	2.0	574	2.0	0.525	5.4	LOS A	1.8	13.0	0.60	0.52	0.60	30.0
All Vehicles			1885	1.4	1885	1.4	0.940	14.2	LOS A	7.9	55.5	0.79	0.98	1.29	33.5

Site Level of Service (LOS) Method: Delay (RTA NSW). Site LOS Method is specified in the Network Data dialog (Override Site Data tab).

Vehicle movement LOS values are based on average delay per movement.

Intersection and Approach LOS values are based on average delay for all vehicle movements.

Roundabout Capacity Model: SIDRA Standard.

Delay Model: SIDRA Standard (Control Delay: Geometric Delay is included).

Queue Model: SIDRA queue estimation methods are used for Back of Queue and Queue at Start of Gap.

Gap-Acceptance Capacity Formula: SIDRA Standard (Akçelik M3D).

HV (%) values are calculated for All Movement Classes of All Heavy Vehicle Model Designation.

Arrival Flows used in performance calculations are adjusted to include any Initial Queued Demand and Upstream Capacity Constraint effects.

SIDRA INTERSECTION 9.1 | Copyright © 2000-2023 Akcelik and Associates Pty Ltd | sidrasolutions.com

Organisation: SCT CONSULTING PTY LTD | Licence: NETWORK / 1PC | Processed: Thursday, 19 October 2023 3:10:11 PM

Project: S:\Projects\SCT_00410_Cumberland Westmead Sth Transport Study\3. Technical Work Area\1. Network Optimisation\SCT_00410_Cumberland Westmead Sth_SIDRA_v0.5_upg2_sg0.9.sip9

MOVEMENT SUMMARY

Site: 2AM [BRI_GRA_23_2AM_DL (Site Folder: Network 2)]

Output produced by SIDRA INTERSECTION Version: 9.1.4.221

Network: N101 [Network 2 - AM - Roundabout (Network Folder: Base Year_DL)]

Bridge Road and Grand Avenue (8:00 to 9:00 AM)

TCS 1570

Site Category: Base Year

Signals - EQUISAT (Fixed-Time/SCATS) Coordinated Cycle Time = 50 seconds (Site Practical Cycle Time)

Vehicle Movement Performance															
Mov ID	Turn	Mov Class	Demand Flows [Total HV]		Arrival Flows [Total HV]		Deg. Satn	Aver. Delay	Level of Service	Aver. Back Of Queue [Veh. Dist]		Prop. Que	Eff. Stop Rate	Aver. No. of Cycles	Aver. Speed
			veh/h	%	veh/h	%	v/c	sec		veh	m				km/h
South: Bridge Road (S)															
1	L2	All MCs	126	2.0	126	2.0	0.191	21.8	LOS B	1.9	13.5	1.00	0.69	1.00	30.4
2	T1	All MCs	275	2.0	275	2.0	0.341	18.2	LOS B	4.1	29.5	1.00	0.68	1.00	8.7
Approach			401	2.0	401	2.0	0.341	19.3	LOS B	4.1	29.5	1.00	0.68	1.00	20.8
East: Grand Avenue															
4	L2	All MCs	1	0.0	1	0.0	0.013	19.4	LOS B	0.0	0.4	0.78	0.60	0.78	34.4
5	T1	All MCs	1	0.0	1	0.0	0.013	12.5	LOS A	0.0	0.4	0.78	0.60	0.78	40.0
6	R2	All MCs	2	50.0	2	50.0	0.013	23.3	LOS B	0.0	0.4	0.78	0.60	0.78	34.7
Approach			4	25.0	4	25.0	0.013	19.6	LOS B	0.0	0.4	0.78	0.60	0.78	36.4
North: Bridge Road (N)															
7	L2	All MCs	1	0.0	1	0.0	0.556	19.6	LOS B	4.9	35.1	0.81	0.70	0.81	38.7
8	T1	All MCs	849	2.0	849	2.0	*0.556	12.6	LOS A	4.9	35.1	0.81	0.70	0.81	20.4
Approach			850	2.0	850	2.0	0.556	12.6	LOS A	4.9	35.1	0.81	0.70	0.81	20.0
West: Veron Street															
10	L2	All MCs	203	2.0	203	2.0	0.406	21.6	LOS B	2.6	18.3	0.86	0.78	0.86	31.0
11	T1	All MCs	325	2.0	325	2.0	*0.510	14.7	LOS B	4.0	28.5	0.85	0.72	0.85	42.0
Approach			528	2.0	528	2.0	0.510	17.3	LOS B	4.0	28.5	0.85	0.74	0.85	39.0
All Vehicles			1784	2.1	1784	2.1	0.556	15.5	LOS B	4.9	35.1	0.86	0.71	0.86	30.9

Site Level of Service (LOS) Method: Delay (RTA NSW). Site LOS Method is specified in the Network Data dialog (Override Site Data tab).

Vehicle movement LOS values are based on average delay per movement.

Intersection and Approach LOS values are based on average delay for all vehicle movements.

Delay Model: SIDRA Standard (Control Delay: Geometric Delay is included).

Queue Model: SIDRA queue estimation methods are used for Back of Queue and Queue at Start of Green.

Gap-Acceptance Capacity Formula: SIDRA Standard (Akçelik M3D).

HV (%) values are calculated for All Movement Classes of All Heavy Vehicle Model Designation.

Arrival Flows used in performance calculations are adjusted to include any Initial Queued Demand and Upstream Capacity Constraint effects.

* Critical Movement (Signal Timing)

Pedestrian Movement Performance												
Mov ID	Crossing	Dem. Flow ped/h	Aver. Delay sec	Level of Service	AVERAGE BACK OF QUEUE [Ped ped Dist] m		Prop. Que	Eff. Stop Rate	Travel Time sec	Travel Dist. m	Aver. Speed m/sec	
South: Bridge Road (S)												
P1	Full	211	19.5	LOS B	0.3	0.3	0.89	0.89	173.4	200.0	1.15	
East: Grand Avenue												
P2	Full	211	19.5	LOS B	0.3	0.3	0.89	0.89	173.4	200.0	1.15	
North: Bridge Road (N)												
P3	Full	211	19.5	LOS B	0.3	0.3	0.89	0.89	173.4	200.0	1.15	
West: Veron Street												
P4	Full	211	19.5	LOS B	0.3	0.3	0.89	0.89	173.4	200.0	1.15	
All Pedestrians		842	19.5	LOS B	0.3	0.3	0.89	0.89	173.4	200.0	1.15	

Level of Service (LOS) Method: SIDRA Pedestrian LOS Method (Based on Average Delay)

Pedestrian movement LOS values are based on average delay per pedestrian movement.

Intersection LOS value for Pedestrians is based on average delay for all pedestrian movements.

SIDRA INTERSECTION 9.1 | Copyright © 2000-2023 Akcelik and Associates Pty Ltd | sidrasolutions.com

Organisation: SCT CONSULTING PTY LTD | Licence: NETWORK / 1PC | Processed: Thursday, 19 October 2023 3:10:11 PM

Project: S:\Projects\SCT_00410_Cumberland Westmead Sth Transport Study\3. Technical Work Area\1. Network Optimisation\SCT_00410_Cumberland Westmead Sth_SIDRA_v0.5_upg2_sg0.9.sip9

MOVEMENT SUMMARY

Site: 21PM [BRI_MON_23_21PM_DL (Site Folder: Network 2)]

Output produced by SIDRA INTERSECTION Version: 9.1.4.221

Network: N101 [Network 2 - PM - Roundabout (Network Folder: Base Year_DL)]

Bridge Road and Entry to Monarco (5:00 to 6:00 PM)

Site Category: Base Year

Roundabout

Vehicle Movement Performance															
Mov ID	Turn	Mov Class	Demand Flows		Arrival Flows		Deg. Satn	Aver. Delay	Level of Service	Aver. Back Of Queue		Prop. Que	Eff. Stop Rate	Aver. No. of Cycles	Aver. Speed
			[Total	HV]	[Total	HV]				[Veh.	Dist]				
			veh/h	%	veh/h	%	v/c	sec		veh	m				
South: Bridge Road (S)															
2	T1	All MCs	574	2.0	312	2.0	0.194	3.9	LOS A	0.4	2.9	0.03	0.45	0.03	42.6
3	R2	All MCs	1	0.0	1	0.0	0.194	6.5	LOS A	0.4	2.9	0.03	0.45	0.03	38.3
3u	U	All MCs	1	0.0	1	0.0	0.194	7.8	LOS A	0.4	2.9	0.03	0.45	0.03	35.3
Approach			576	2.0	313	2.0	0.194	3.9	LOS A	0.4	2.9	0.03	0.45	0.03	42.5
East: Monarco Entry															
4	L2	All MCs	1	0.0	1	0.0	0.009	9.6	LOS A	0.0	0.1	0.82	0.67	0.82	26.3
6	R2	All MCs	1	0.0	1	0.0	0.009	11.7	LOS A	0.0	0.1	0.82	0.67	0.82	35.8
6u	U	All MCs	1	0.0	1	0.0	0.009	13.0	LOS A	0.0	0.1	0.82	0.67	0.82	31.7
Approach			3	0.0	3	0.0	0.009	11.4	LOS A	0.0	0.1	0.82	0.67	0.82	32.3
North: Bridge Road (N)															
7	L2	All MCs	1	0.0	1	0.0	1.031	34.0	LOS C	32.6	232.3	1.00	1.01	1.02	24.6
8	T1	All MCs	852	2.0	852	2.0	1.031	33.1	LOS C	32.6	232.3	1.00	1.01	1.02	20.6
9u	U	All MCs	1	0.0	1	0.0	1.031	37.0	LOS C	32.6	232.3	1.00	1.01	1.02	28.0
Approach			854	2.0	854	2.0	1.031	33.1	LOS C	32.6	232.3	1.00	1.01	1.02	20.6
All Vehicles			1433	2.0	1170	2.4	1.031	25.2	LOS B	32.6	232.3	0.74	0.86	0.75	24.9

Site Level of Service (LOS) Method: Delay (RTA NSW). Site LOS Method is specified in the Network Data dialog (Override Site Data tab).

Vehicle movement LOS values are based on average delay per movement.

Intersection and Approach LOS values are based on average delay for all vehicle movements.

Roundabout Capacity Model: SIDRA Standard.

Delay Model: SIDRA Standard (Control Delay: Geometric Delay is included).

Queue Model: SIDRA queue estimation methods are used for Back of Queue and Queue at Start of Gap.

Gap-Acceptance Capacity Formula: SIDRA Standard (Akçelik M3D).

HV (%) values are calculated for All Movement Classes of All Heavy Vehicle Model Designation.

Arrival Flows used in performance calculations are adjusted to include any Initial Queued Demand and Upstream Capacity Constraint effects.

SIDRA INTERSECTION 9.1 | Copyright © 2000-2023 Akcelik and Associates Pty Ltd | sidrasolutions.com

Organisation: SCT CONSULTING PTY LTD | Licence: NETWORK / 1PC | Processed: Thursday, 19 October 2023 3:10:15 PM

Project: S:\Projects\SCT_00410_Cumberland Westmead Sth Transport Study\3. Technical Work Area\1. Network Optimisation\SCT_00410_Cumberland Westmead Sth_SIDRA_v0.5_upg2_sg0.9.sip9

MOVEMENT SUMMARY

Site: 24PMe [BRI_ALE_23_24PM_DL (Site Folder: Network 2)]

Output produced by SIDRA INTERSECTION Version: 9.1.4.221

Network: N101 [Network 2 - PM - Roundabout (Network Folder: Base Year_DL)]

Bridge Road and Alexandra Avenue (5:00 to 6:00 PM)

Site Category: Base Year

Roundabout

Vehicle Movement Performance															
Mov ID	Turn	Mov Class	Demand Flows		Arrival Flows		Deg. Satn	Aver. Delay	Level of Service	Aver. Back Of Queue		Prop. Que	Eff. Stop Rate	Aver. No. of Cycles	Aver. Speed
			[Total	HV]	[Total	HV]				[Veh.	Dist]				
			veh/h	%	veh/h	%	v/c	sec		veh	m				km/h
South: Bridge Road (S)															
2	T1	All MCs	278	2.0	278	2.0	0.373	4.7	LOS A	0.7	5.1	0.37	0.60	0.37	25.1
3	R2	All MCs	101	0.0	101	0.0	0.373	7.6	LOS A	0.7	5.1	0.37	0.60	0.37	43.1
3u	U	All MCs	2	0.0	2	0.0	0.373	9.0	LOS A	0.7	5.1	0.37	0.60	0.37	25.1
Approach			382	1.5	382	1.5	0.373	5.5	LOS A	0.7	5.1	0.37	0.60	0.37	36.7
East: Alexandra Avenue															
4	L2	All MCs	522	0.0	522	0.0	2.706	1546.8	LOS F	196.5	1388.9	1.00	12.55	29.01	1.5
6	R2	All MCs	703	2.0	703	2.0	2.706	1549.1	LOS F	196.5	1388.9	1.00	12.55	29.01	1.5
6u	U	All MCs	1	0.0	1	0.0	2.706	1550.4	LOS F	196.5	1388.9	1.00	12.55	29.01	2.8
Approach			1227	1.1	1227	1.1	2.706	1548.1	LOS F	196.5	1388.9	1.00	12.55	29.01	1.5
North: Bridge Road (N)															
7	L2	All MCs	1	0.0	1	0.0	1.066	72.2	LOS F	16.6	118.0	1.00	1.69	2.22	21.4
8	T1	All MCs	919	2.0	894	2.0	1.066	71.9	LOS F	16.6	118.0	1.00	1.69	2.22	6.0
9u	U	All MCs	1	0.0	1	0.0	1.066	76.1	LOS F	16.6	118.0	1.00	1.69	2.22	6.0
Approach			922	2.0	896	2.0	1.066	71.9	LOS F	16.6	118.0	1.00	1.69	2.22	6.0
All Vehicles			2530	1.5	2504	1.5	2.706	784.9	LOS F	196.5	1388.9	0.90	6.84	15.07	1.8

Site Level of Service (LOS) Method: Delay (RTA NSW). Site LOS Method is specified in the Network Data dialog (Override Site Data tab).

Vehicle movement LOS values are based on average delay per movement.

Intersection and Approach LOS values are based on average delay for all vehicle movements.

Roundabout Capacity Model: SIDRA Standard.

Delay Model: SIDRA Standard (Control Delay: Geometric Delay is included).

Queue Model: SIDRA queue estimation methods are used for Back of Queue and Queue at Start of Gap.

Gap-Acceptance Capacity Formula: SIDRA Standard (Akçelik M3D).

HV (%) values are calculated for All Movement Classes of All Heavy Vehicle Model Designation.

Arrival Flows used in performance calculations are adjusted to include any Initial Queued Demand and Upstream Capacity Constraint effects.

SIDRA INTERSECTION 9.1 | Copyright © 2000-2023 Akcelik and Associates Pty Ltd | sidrasolutions.com

Organisation: SCT CONSULTING PTY LTD | Licence: NETWORK / 1PC | Processed: Thursday, 19 October 2023 3:10:15 PM

Project: S:\Projects\SCT_00410_Cumberland Westmead Sth Transport Study\3. Technical Work Area\1. Network Optimisation\SCT_00410_Cumberland Westmead Sth_SIDRA_v0.5_upg2_sg0.9.sip9

MOVEMENT SUMMARY

Site: 2PM [BRI_GRA_23_2PM_DL (Site Folder: Network 2)]

Output produced by SIDRA INTERSECTION Version: 9.1.4.221

Network: N101 [Network 2 - PM - Roundabout (Network Folder: Base Year_DL)]

Bridge Road and Grand Avenue (5:00 to 6:00 PM)

TCS 1570

Site Category: Base Year

Signals - EQUISAT (Fixed-Time/SCATS) Isolated Cycle Time = 60 seconds (Site Practical Cycle Time)

Vehicle Movement Performance															
Mov ID	Turn	Mov Class	Demand Flows [Total HV]		Arrival Flows [Total HV]		Deg. Satn	Aver. Delay	Level of Service	Aver. Back Of Queue [Veh. Dist]		Prop. Que	Eff. Stop Rate	Aver. No. of Cycles	Aver. Speed
			veh/h	%	veh/h	%	v/c	sec		veh	m				km/h
South: Bridge Road (S)															
1	L2	All MCs	148	2.0	148	2.0	0.169	13.9	LOS A	1.6	11.3	0.63	0.70	0.63	35.0
2	T1	All MCs	278	2.0	278	2.0	0.280	8.9	LOS A	2.8	20.2	0.60	0.51	0.60	15.1
Approach			426	2.0	426	2.0	0.280	10.6	LOS A	2.8	20.2	0.61	0.58	0.61	28.8
East: Grand Avenue															
4	L2	All MCs	1	0.0	1	0.0	0.015	24.9	LOS B	0.1	0.5	0.81	0.61	0.81	32.3
5	T1	All MCs	1	0.0	1	0.0	0.015	17.0	LOS B	0.1	0.5	0.81	0.61	0.81	38.3
6	R2	All MCs	2	50.0	2	50.0	0.015	27.0	LOS B	0.1	0.5	0.81	0.61	0.81	32.5
Approach			4	25.0	4	25.0	0.015	24.0	LOS B	0.1	0.5	0.81	0.61	0.81	34.3
North: Bridge Road (N)															
7	L2	All MCs	1	0.0	1	0.0	* 0.714	24.2	LOS B	7.5	53.9	0.82	0.76	0.87	38.0
8	T1	All MCs	1442	2.0	1035	2.6	0.714	16.2	LOS B	7.5	53.9	0.82	0.76	0.87	19.3
Approach			1443	2.0	1035	2.6	0.714	16.2	LOS B	7.5	53.9	0.82	0.76	0.87	17.0
West: Veron Street															
10	L2	All MCs	101	2.0	101	2.0	0.262	26.9	LOS B	1.6	11.2	0.87	0.75	0.87	28.2
11	T1	All MCs	238	2.0	238	2.0	* 0.448	19.6	LOS B	3.6	25.7	0.87	0.72	0.87	39.8
Approach			340	2.0	340	2.0	0.448	21.8	LOS B	3.6	25.7	0.87	0.73	0.87	37.4
All Vehicles			2213	2.0	1805	2.5	0.714	16.0	LOS B	7.5	53.9	0.78	0.71	0.81	28.0

Site Level of Service (LOS) Method: Delay (RTA NSW). Site LOS Method is specified in the Network Data dialog (Override Site Data tab).

Vehicle movement LOS values are based on average delay per movement.

Intersection and Approach LOS values are based on average delay for all vehicle movements.

Delay Model: SIDRA Standard (Control Delay: Geometric Delay is included).

Queue Model: SIDRA queue estimation methods are used for Back of Queue and Queue at Start of Green.

Gap-Acceptance Capacity Formula: SIDRA Standard (Akçelik M3D).

HV (%) values are calculated for All Movement Classes of All Heavy Vehicle Model Designation.

Arrival Flows used in performance calculations are adjusted to include any Initial Queued Demand and Upstream Capacity Constraint effects.

* Critical Movement (Signal Timing)

Pedestrian Movement Performance												
Mov ID	Crossing	Dem. Flow ped/h	Aver. Delay sec	Level of Service	AVERAGE BACK OF QUEUE [Ped ped Dist] m		Prop. Que	Eff. Stop Rate	Travel Time sec	Travel Dist. m	Aver. Speed m/sec	
South: Bridge Road (S)												
P1	Full	211	24.5	LOS C	0.3	0.3	0.91	0.91	178.4	200.0	1.12	
East: Grand Avenue												
P2	Full	211	24.5	LOS C	0.3	0.3	0.91	0.91	178.4	200.0	1.12	
North: Bridge Road (N)												
P3	Full	211	24.5	LOS C	0.3	0.3	0.91	0.91	178.4	200.0	1.12	
West: Veron Street												
P4	Full	211	24.5	LOS C	0.3	0.3	0.91	0.91	178.4	200.0	1.12	
All Pedestrians		842	24.5	LOS C	0.3	0.3	0.91	0.91	178.4	200.0	1.12	

Level of Service (LOS) Method: SIDRA Pedestrian LOS Method (Based on Average Delay)

Pedestrian movement LOS values are based on average delay per pedestrian movement.

Intersection LOS value for Pedestrians is based on average delay for all pedestrian movements.

SIDRA INTERSECTION 9.1 | Copyright © 2000-2023 Akcelik and Associates Pty Ltd | sidrasolutions.com

Organisation: SCT CONSULTING PTY LTD | Licence: NETWORK / 1PC | Processed: Thursday, 19 October 2023 3:10:15 PM

Project: S:\Projects\SCT_00410_Cumberland Westmead Sth Transport Study\3. Technical Work Area\1. Network Optimisation\SCT_00410_Cumberland Westmead Sth_SIDRA_v0.5_upg2_sg0.9.sip9

MOVEMENT SUMMARY

Site: 4AM [BRI_GWH_23_4AM_O2 (Site Folder: Network 3)]

Output produced by SIDRA INTERSECTION Version: 9.1.4.221

Network: N101 [Network 3 - AM (Network Folder: Base Year_DL)]

Bridge Road and Great Western Highway

TCS 1248 - SS 2

8:00 AM to 9:00 AM Base year demand

Site Category: Base Year

Signals - EQUISAT (Fixed-Time/SCATS) Coordinated Cycle Time = 141 seconds (Network User-Given Cycle Time)

Vehicle Movement Performance															
Mov ID	Turn	Mov Class	Demand Flows [Total HV]		Arrival Flows [Total HV]		Deg. Satn	Aver. Delay	Level of Service	Aver. Back Of Queue [Veh. Dist]		Prop. Que	Eff. Stop Rate	Aver. No. of Cycles	Aver. Speed
			veh/h	%	veh/h	%	v/c	sec		veh	m				km/h
East: Great Western Highway (E)															
5	T1	All MCs	834	4.4	834	4.4	0.284	4.1	LOS A	6.7	48.0	0.23	0.18	0.23	53.9
6	R2	All MCs	379	2.3	379	2.3	* 1.083	109.7	LOS F	12.8	91.0	1.00	1.19	1.60	18.1
Approach			1213	3.7	1213	3.7	1.083	37.1	LOS C	12.8	91.0	0.47	0.49	0.66	30.3
North: Bridge Road (N)															
7	L2	All MCs	549	2.0	549	2.0	1.355	338.2	LOS F	52.0	370.1	1.00	1.79	2.72	6.6
9	R2	All MCs	213	2.0	213	2.0	* 1.098	184.4	LOS F	7.0	49.6	1.00	1.21	1.84	17.5
Approach			761	2.0	761	2.0	1.355	295.3	LOS F	52.0	370.1	1.00	1.63	2.48	8.6
West: Great Western Highway (W)															
10	L2	All MCs	5	1.9	5	1.9	0.035	6.2	LOS A	0.0	0.3	0.02	0.14	0.02	51.5
11	T1	All MCs	1320	3.5	1320	3.5	* 1.077	93.8	LOS F	43.6	310.8	0.99	1.46	1.59	14.9
Approach			1325	3.5	1325	3.5	1.077	93.5	LOS F	43.6	310.8	0.98	1.46	1.58	15.0
All Vehicles			3299	3.2	3299	3.2	1.355	119.3	LOS F	52.0	370.1	0.80	1.14	1.45	14.4

Site Level of Service (LOS) Method: Delay (RTA NSW). Site LOS Method is specified in the Network Data dialog (Override Site Data tab).

Vehicle movement LOS values are based on average delay per movement.

Intersection and Approach LOS values are based on average delay for all vehicle movements.

Delay Model: SIDRA Standard (Control Delay: Geometric Delay is included).

Queue Model: SIDRA queue estimation methods are used for Back of Queue and Queue at Start of Green.

Gap-Acceptance Capacity Formula: SIDRA Standard (Akçelik M3D).

HV (%) values are calculated for All Movement Classes of All Heavy Vehicle Model Designation.

Arrival Flows used in performance calculations are adjusted to include any Initial Queued Demand and Upstream Capacity Constraint effects.

* Critical Movement (Signal Timing)

Pedestrian Movement Performance												
Mov ID	Crossing	Dem. Flow ped/h	Aver. Delay sec	Level of Service	AVERAGE BACK OF QUEUE [Ped Dist] ped m		Prop. Que	Eff. Stop Rate	Travel Time sec	Travel Dist. m	Aver. Speed m/sec	
North: Bridge Road (N)												
P3	Full	53	64.8	LOS F	0.2	0.2	0.96	0.96	218.6	200.0	0.91	
West: Great Western Highway (W)												
P41	Stage 1	53	64.8	LOS F	0.2	0.2	0.96	0.96	218.6	200.0	0.91	
P42	Stage 2	53	64.8	LOS F	0.2	0.2	0.96	0.96	218.6	200.0	0.91	
All Pedestrians		158	64.8	LOS F	0.2	0.2	0.96	0.96	218.6	200.0	0.91	

Level of Service (LOS) Method: SIDRA Pedestrian LOS Method (Based on Average Delay)
 Pedestrian movement LOS values are based on average delay per pedestrian movement.
 Intersection LOS value for Pedestrians is based on average delay for all pedestrian movements.

MOVEMENT SUMMARY

Site: 5AM [HAW_GWH_23_5AM_DL_O2 (Site Folder: Network 3)]

Output produced by SIDRA INTERSECTION Version: 9.1.4.221

Network: N101 [Network 3 - AM (Network Folder: Base Year_DL)]

TCS 502 - SS 2

8:00 AM to 9:00 AM Base year demand

Site Category: Base Year

Signals - EQUISAT (Fixed-Time/SCATS) Coordinated Cycle Time = 141 seconds (Network User-Given Cycle Time)

Vehicle Movement Performance															
Mov ID	Turn	Mov Class	Demand Flows [Total HV]	Flows %	Arrival Flows [Total HV]	Flows %	Deg. Satn	Aver. Delay	Level of Service	Aver. Back Of Queue [Veh. Dist]	Prop. Que	Eff. Stop Rate	Aver. No. of Cycles	Aver. Speed	
			veh/h	%	veh/h	%	v/c	sec		veh	m				km/h
South: Coleman Street (S)															
1	L2	All MCs	393	2.0	393	2.0	0.646	21.4	LOS B	10.8	76.6	0.74	0.81	0.74	35.8
2	T1	All MCs	320	2.0	320	2.0	*0.916	77.8	LOS F	14.3	101.8	1.00	1.07	1.28	26.5
3	R2	All MCs	258	2.0	258	2.0	0.916	84.2	LOS F	13.5	95.9	1.00	1.02	1.29	25.0
Approach			971	2.0	971	2.0	0.916	56.6	LOS E	14.3	101.8	0.89	0.95	1.06	27.8
East: Great Western Highway (E)															
4	L2	All MCs	69	2.0	69	2.0	0.084	7.3	LOS A	0.7	5.5	0.33	0.55	0.33	51.1
5	T1	All MCs	599	5.4	599	5.4	0.536	11.3	LOS A	10.4	74.0	0.46	0.43	0.46	44.2
6	R2	All MCs	529	1.8	529	1.8	*0.950	93.4	LOS F	13.6	96.5	1.00	1.05	1.38	23.4
Approach			1197	3.6	1197	3.6	0.950	47.4	LOS D	13.6	96.5	0.69	0.71	0.86	29.3
North: Hawkesbury Road (N)															
7	L2	All MCs	403	2.0	403	2.0	0.757	64.6	LOS E	15.0	106.9	0.94	0.87	0.96	32.5
8	T1	All MCs	164	2.0	164	2.0	*0.920	96.6	LOS F	11.8	83.9	1.00	1.08	1.33	25.6
9	R2	All MCs	220	2.0	220	2.0	0.920	97.0	LOS F	11.8	83.9	1.00	1.06	1.40	15.5
Approach			787	2.0	787	2.0	0.920	80.3	LOS F	15.0	106.9	0.97	0.96	1.16	23.5
West: Great Western Highway (W)															
10	L2	All MCs	450	2.0	392	2.0	0.504	22.4	LOS B	7.9	58.8	0.88	0.75	0.88	34.6
11	T1	All MCs	1419	3.4	1240	3.6	*0.903	37.5	LOS C	12.8	91.0	0.96	0.92	1.04	29.9
Approach			1869	3.1	1632	3.2	0.903	33.9	LOS C	12.8	91.0	0.94	0.88	1.00	30.9
All Vehicles			4824	2.8	4587	3.0	0.950	50.2	LOS D	15.0	106.9	0.87	0.87	1.00	28.0

Site Level of Service (LOS) Method: Delay (RTA NSW). Site LOS Method is specified in the Network Data dialog (Override Site Data tab).

Vehicle movement LOS values are based on average delay per movement.

Intersection and Approach LOS values are based on average delay for all vehicle movements.

Delay Model: SIDRA Standard (Control Delay: Geometric Delay is included).

Queue Model: SIDRA queue estimation methods are used for Back of Queue and Queue at Start of Green.

Gap-Acceptance Capacity Formula: SIDRA Standard (Akçelik M3D).

HV (%) values are calculated for All Movement Classes of All Heavy Vehicle Model Designation.

Arrival Flows used in performance calculations are adjusted to include any Initial Queued Demand and Upstream Capacity Constraint effects.

* Critical Movement (Signal Timing)

Pedestrian Movement Performance											
Mov ID	Crossing	Dem. Flow ped/h	Aver. Delay sec	Level of Service	AVERAGE BACK OF QUEUE [Ped Dist]		Prop. Que	Eff. Stop Rate	Travel Time sec	Travel Dist. m	Aver. Speed m/sec
South: Coleman Street (S)											
P1	Full	53	64.8	LOS F	0.2	0.2	0.96	0.96	218.6	200.0	0.91
East: Great Western Highway (E)											
P2	Full	11	64.7	LOS F	0.0	0.0	0.96	0.96	218.5	200.0	0.92
North: Hawkesbury Road (N)											
P3	Full	53	64.8	LOS F	0.2	0.2	0.96	0.96	218.6	200.0	0.91
All Pedestrians		116	64.8	LOS F	0.2	0.2	0.96	0.96	218.6	200.0	0.91

Level of Service (LOS) Method: SIDRA Pedestrian LOS Method (Based on Average Delay)

Pedestrian movement LOS values are based on average delay per pedestrian movement.

Intersection LOS value for Pedestrians is based on average delay for all pedestrian movements.

SIDRA INTERSECTION 9.1 | Copyright © 2000-2023 Akcelik and Associates Pty Ltd | sidrasolutions.com

Organisation: SCT CONSULTING PTY LTD | Licence: NETWORK / 1PC | Processed: Thursday, 19 October 2023 3:21:38 PM

Project: S:\Projects\SCT_00410_Cumberland Westmead Sth Transport Study\3. Technical Work Area\1. Network Optimisation\SCT_00410_Cumberland Westmead Sth_SIDRA_v0.5_upg2_sg0.9.sip9

MOVEMENT SUMMARY

Site: 4PM [BRI_GWH_23_4PM_O2 (Site Folder: Network 3)]

Output produced by SIDRA INTERSECTION Version: 9.1.4.221

Network: N102 [Network 3 - PM (Network Folder: Base Year_DL)]

Bridge Road and Great Western Highway

TCS 1248 - SS 2

5:00 PM to 6:00 PM Base year demand

Site Category: Base Year

Signals - EQUISAT (Fixed-Time/SCATS) Coordinated Cycle Time = 141 seconds (Network Site User-Given Phase Times)

Vehicle Movement Performance															
Mov ID	Turn	Mov Class	Demand Flows [Total HV]		Arrival Flows [Total HV]		Deg. Satn	Aver. Delay	Level of Service	Aver. Back Of Queue [Veh. Dist]		Prop. Que	Eff. Stop Rate	Aver. No. of Cycles	Aver. Speed
			veh/h	%	veh/h	%	v/c	sec		veh	m				km/h
East: Great Western Highway (E)															
5	T1	All MCs	1635	2.7	1247	2.9	0.462	1.9	LOS A	3.3	23.2	0.14	0.13	0.14	57.1
6	R2	All MCs	589	2.0	448	2.0	*0.959	79.8	LOS F	12.8	91.0	1.00	1.04	1.27	21.9
Approach			2224	2.5	1695	2.7	0.959	22.5	LOS B	12.8	91.0	0.37	0.37	0.44	37.0
North: Bridge Road (N)															
7	L2	All MCs	807	2.0	807	2.0	1.296	307.3	LOS F	70.2	500.1	1.00	1.79	2.50	7.2
9	R2	All MCs	274	2.0	274	2.0	*0.929	94.8	LOS F	8.5	60.7	1.00	1.05	1.28	25.7
Approach			1081	2.0	1081	2.0	1.296	253.4	LOS F	70.2	500.1	1.00	1.60	2.19	9.4
West: Great Western Highway (W)															
10	L2	All MCs	1	0.0	1	0.0	0.021	12.5	LOS A	0.1	1.2	0.19	0.18	0.19	48.6
11	T1	All MCs	916	3.3	916	3.3	*0.916	24.0	LOS B	16.2	115.0	0.72	0.77	0.86	33.8
Approach			917	3.3	917	3.3	0.916	24.0	LOS B	16.2	115.0	0.72	0.77	0.86	33.8
All Vehicles			4223	2.5	3694	2.9	1.296	90.4	LOS F	70.2	500.1	0.64	0.83	1.06	17.4

Site Level of Service (LOS) Method: Delay (RTA NSW). Site LOS Method is specified in the Network Data dialog (Override Site Data tab).

Vehicle movement LOS values are based on average delay per movement.

Intersection and Approach LOS values are based on average delay for all vehicle movements.

Delay Model: SIDRA Standard (Control Delay: Geometric Delay is included).

Queue Model: SIDRA queue estimation methods are used for Back of Queue and Queue at Start of Green.

Gap-Acceptance Capacity Formula: SIDRA Standard (Akçelik M3D).

HV (%) values are calculated for All Movement Classes of All Heavy Vehicle Model Designation.

Arrival Flows used in performance calculations are adjusted to include any Initial Queued Demand and Upstream Capacity Constraint effects.

* Critical Movement (Signal Timing)

Pedestrian Movement Performance												
Mov ID	Crossing	Dem. Flow ped/h	Aver. Delay sec	Level of Service	AVERAGE BACK OF QUEUE [Ped Dist] ped m		Prop. Que	Eff. Stop Rate	Travel Time sec	Travel Dist. m	Aver. Speed m/sec	
North: Bridge Road (N)												
P3	Full	53	64.8	LOS F	0.2	0.2	0.96	0.96	218.6	200.0	0.91	
West: Great Western Highway (W)												
P41	Stage 1	53	64.8	LOS F	0.2	0.2	0.96	0.96	218.6	200.0	0.91	
P42	Stage 2	53	64.8	LOS F	0.2	0.2	0.96	0.96	218.6	200.0	0.91	
All Pedestrians		158	64.8	LOS F	0.2	0.2	0.96	0.96	218.6	200.0	0.91	

Level of Service (LOS) Method: SIDRA Pedestrian LOS Method (Based on Average Delay)

Pedestrian movement LOS values are based on average delay per pedestrian movement.

Intersection LOS value for Pedestrians is based on average delay for all pedestrian movements.

SIDRA INTERSECTION 9.1 | Copyright © 2000-2023 Akcelik and Associates Pty Ltd | sidrasolutions.com

Organisation: SCT CONSULTING PTY LTD | Licence: NETWORK / 1PC | Processed: Thursday, 19 October 2023 3:42:29 PM

Project: S:\Projects\SCT_00410_Cumberland Westmead Sth Transport Study\3. Technical Work Area\1. Network Optimisation\SCT_00410_Cumberland Westmead Sth_SIDRA_v0.5_upg2_sg0.9.sip9

MOVEMENT SUMMARY

Site: 5PM [HAW_GWH_23_5PM_DL_O2 (Site Folder: Network 3)]

Output produced by SIDRA INTERSECTION Version: 9.1.4.221

Network: N102 [Network 3 - PM (Network Folder: Base Year_DL)]

TCS 502 - SS 2

5:00 PM to 6:00 PM Base year demand

Site Category: Base Year

Signals - EQUISAT (Fixed-Time/SCATS) Coordinated Cycle Time = 141 seconds (Network Site User-Given Phase Times)

Vehicle Movement Performance															
Mov ID	Turn	Mov Class	Demand Flows [Total]	Flows HV]	Arrival Flows [Total]	Flows HV]	Deg. Satn	Aver. Delay	Level of Service	Aver. Back Of Queue [Veh.]	Dist]	Prop. Que	Eff. Stop Rate	Aver. No. of Cycles	Aver. Speed
			veh/h	%	veh/h	%	v/c	sec		veh	m				km/h
South: Coleman Street (S)															
1	L2	All MCs	521	2.0	521	2.0	2.693	1571.8	LOS F	86.7	617.2	1.00	2.64	5.03	1.2
2	T1	All MCs	378	2.0	378	2.0	* 3.012	1890.8	LOS F	46.6	331.8	1.00	2.43	5.28	1.9
3	R2	All MCs	122	2.0	122	2.0	3.012	1896.6	LOS F	44.5	317.2	1.00	2.41	5.28	1.9
Approach			1021	2.0	1021	2.0	3.012	1728.8	LOS F	86.7	617.2	1.00	2.54	5.15	1.5
East: Great Western Highway (E)															
4	L2	All MCs	157	2.0	157	2.0	0.112	21.4	LOS B	1.0	7.5	0.18	0.57	0.18	52.3
5	T1	All MCs	1519	2.8	1519	2.8	* 1.138	172.5	LOS F	109.1	777.1	0.99	1.66	1.83	9.9
6	R2	All MCs	690	2.0	690	2.0	0.893	76.3	LOS F	16.0	114.0	1.00	0.99	1.21	26.3
Approach			2366	2.5	2366	2.5	1.138	134.4	LOS F	109.1	777.1	0.94	1.39	1.54	14.2
North: Hawkesbury Road (N)															
7	L2	All MCs	366	2.0	366	2.0	0.665	58.3	LOS E	12.9	91.6	0.90	0.84	0.90	33.4
8	T1	All MCs	168	2.0	168	2.0	1.145	226.6	LOS F	17.3	123.4	1.00	1.47	2.08	13.3
9	R2	All MCs	185	2.0	185	2.0	1.145	229.5	LOS F	17.3	123.4	1.00	1.40	2.15	7.4
Approach			719	2.0	719	2.0	1.145	141.6	LOS F	17.3	123.4	0.95	1.13	1.50	16.3
West: Great Western Highway (W)															
10	L2	All MCs	401	2.0	358	2.0	* 0.355	17.5	LOS B	7.3	53.6	0.69	0.68	0.69	38.1
11	T1	All MCs	1322	2.9	1181	3.0	0.618	17.3	LOS B	12.8	91.0	0.62	0.56	0.62	40.9
Approach			1723	2.7	1539	2.8	0.618	17.3	LOS B	12.8	91.0	0.63	0.59	0.63	40.2
All Vehicles			5829	2.4	5644	2.5	3.012	391.7	LOS F	109.1	777.1	0.87	1.35	1.94	5.9

Site Level of Service (LOS) Method: Delay (RTA NSW). Site LOS Method is specified in the Network Data dialog (Override Site Data tab).

Vehicle movement LOS values are based on average delay per movement.

Intersection and Approach LOS values are based on average delay for all vehicle movements.

Delay Model: SIDRA Standard (Control Delay: Geometric Delay is included).

Queue Model: SIDRA queue estimation methods are used for Back of Queue and Queue at Start of Green.

Gap-Acceptance Capacity Formula: SIDRA Standard (Akçelik M3D).

HV (%) values are calculated for All Movement Classes of All Heavy Vehicle Model Designation.

Arrival Flows used in performance calculations are adjusted to include any Initial Queued Demand and Upstream Capacity Constraint effects.

* Critical Movement (Signal Timing)

Pedestrian Movement Performance											
Mov ID	Crossing	Dem. Flow ped/h	Aver. Delay sec	Level of Service	AVERAGE BACK OF QUEUE [Ped Dist]		Prop. Que	Eff. Stop Rate	Travel Time sec	Travel Dist. m	Aver. Speed m/sec
South: Coleman Street (S)											
P1	Full	53	64.8	LOS F	0.2	0.2	0.96	0.96	218.6	200.0	0.91
East: Great Western Highway (E)											
P2	Full	11	64.7	LOS F	0.0	0.0	0.96	0.96	218.5	200.0	0.92
North: Hawkesbury Road (N)											
P3	Full	53	64.8	LOS F	0.2	0.2	0.96	0.96	218.6	200.0	0.91
All Pedestrians		116	64.8	LOS F	0.2	0.2	0.96	0.96	218.6	200.0	0.91

Level of Service (LOS) Method: SIDRA Pedestrian LOS Method (Based on Average Delay)

Pedestrian movement LOS values are based on average delay per pedestrian movement.

Intersection LOS value for Pedestrians is based on average delay for all pedestrian movements.

SIDRA INTERSECTION 9.1 | Copyright © 2000-2023 Akcelik and Associates Pty Ltd | sidrasolutions.com

Organisation: SCT CONSULTING PTY LTD | Licence: NETWORK / 1PC | Processed: Thursday, 19 October 2023 3:42:29 PM

Project: S:\Projects\SCT_00410_Cumberland Westmead Sth Transport Study\3. Technical Work Area\1. Network Optimisation\SCT_00410_Cumberland Westmead Sth_SIDRA_v0.5_upg2_sg0.9.sip9



Thoughtful Transport Solutions

Suite 4.03, Level 4, 157 Walker Street, North Sydney NSW 2060
sctconsulting.com.au